

DONE POWER

GLOBAL BRANDED HIGH POWER LIGHTING LED DRIVER ONE-STOP SERVICE PROVIDER



Scan to get the
E-Catalogue



GUANGDONG DONE POWER TECHNOLOGY CO.,LTD



Mart
Oversea Marketing Director
Add: Done Industrial Park, No.3 Kanglong 3rd Rd,Henglan Town, ZhongShan,Guangdong,China 528478
Tel:+86-760-89838379 Fax:+86-760-89838378
MP/Wechat:+8618938770300 WhatsApp:+8618938770300
Website: www.donepower.com Email: done24@donepower.com

NO:3.1.1

DONEPOWER

GLOBAL BRANDED HIGH POWER LIGHTING LED DRIVER ONE-STOP SERVICE PROVIDER



Road lighting



Tunnel lighting



Smart street lighting



Bridge lighting



Plant lighting



Venue lighting



Industrial lighting



Square lighting



Scan to get the
E-Catalogue

DONE LIGHTEN UP PLAN

LIGHT UP THE CITY / LIGHT UP LIFE / LIGHT UP DREAMS

Enterprise brief introduction

Guangdong DONE Power Technology Co.,Ltd was founded in May 2009. After more than 10 years of development, it has won many honors such as Guangdong Science and Technology Innovation Enterprise, Guangdong High tech Technology Enterprise, Guangdong Engineering Technology Research Center, Zhongshan Engineering Technology Research Center, etc. The company now has more than 38,000 square meters of modern standardized workshops and more than 600 employees.

It is a comprehensive brand enterprise integrating outdoor road lighting led driver, smart lighting led driver, plant lighting, agricultural lighting led driver, super high-power stadium lighting led driver, industrial lighting led driver research and development, manufacturing, sales and service.

We always adhere to the business philosophy of "diligence, perseverance, innovation, integrity, teamwork, and cooperation" core idea of the company. "Customer-centered, providing high-quality services; brand-based strategy, insisting on innovative development" is our quality policy; "providing every customer with more valuable high-power solutions" is our eternal goal. We strive to be the top three led driver manufacturers in the industry.

We know that talents are the first asset and core competitiveness for the development and growth of an enterprise. Since the establishment of the company, it has recruited talents and knowledgeable people to make good use of, and has gathered dozens of intermediate and senior electronic technical engineers with many years of research and development experience in the industry. This has enabled Done power to have strong product development and rapid verification capabilities in led driver research and development. With rich development experience, strong technical strength, rigorous quality management, and scientific product manufacturing in the field of high-power led drivers, Done power has won unanimous praise from customers since it was built.

Since 2011, Done Power has confirmed its branded business route with "DONE Power" as the main carrier. For more than ten years, the company has invested heavily in introducing advanced domestic and foreign R&D technologies, various sophisticated R&D and testing equipment, and established Innovative research center, reliability verification and intermediate technical institutions, so that Done Power has the ability to carry out the simulation test of the entire process of led drivers.

ENTERPRISE CULTURE

▶ VISION

To be a century-old company , striving to be one of the top three led driver manufactures.

▶ BRAND VALUES

Honesty / Practicability / High efficiency / Responsibility

▶ MISSION

Dedicate to the development of led drivers around the world, to create values for clients, employees, shareholders and society by utilizing our professional skill and high quality service.

▶ BUSINESS PHILOSOPHY

To be a customer and contributor oriented company, never stop hard working, adhere to self-enhancing.

▶ MANAGEMENT PHILOSOPHY

Taking responsibility, Improving continuously, Executing systematically, Pursuing excellence.

To create high-quality, high-reliability led driver, and to provide the industry with more selective high-power LED drive products is the spirit that Done power always upholds in product research and development. Done has developed technology options and solutions for each product. Design Verification (DVT), Quality Testing (DQT), Product Verification, Raw Material Selection, pilot Production Control, and Mass Production launching follow high standards of refinement and zero defects; the company is developing key components for all products In the process, a full range of application analysis, high and low temperature and its limit test, safety test, EMC test, accelerated aging test, etc. have been carried out to ensure the high reliability and stability of Done products.

In terms of pilot Production, with fast and strong R&D strength and stable quality, the company's products have successively passed CCC, FCC, CB, PSE, TUV, CE, SAA, UL, C-tick and other domestic and foreign product certifications, which are enable Done Power products go abroad and exported to more than 100 countries in Europe, America, the Middle East, Southeast Asia, Australia, Russia, etc. It has established a favorable guarantee. In terms of terminal applications, Done Power is widely used in various lighting projects, municipal engineering, and industrial Lighting products for factories, mines, stadiums, etc.

In terms of marketing network construction, Done has gradually strengthened the construction of its own channels and distribution channels since 2015, established East China and South China operation centers, set up offices in Ningbo, Changzhou, Shenzhen and other places, and successfully developed Fujian, Yangzhou, Distributors in Wenzhou, Danyang, Hebei, Shenzhen, Chengdu and other regions have successfully developed distributors in Brazil ,Russia, Egypt, Turkey, Vietnam and other countries in abroad, laying a solid foundation for Done Power's global market layout.

Done think highly of the construction of corporate culture, implements a good employee welfare system internally, creates a fair and equitable development platform, carries out various corporate cultural activities, continuously improves the company management system, and strives to learn advanced management experience and philosophy from industry benchmark companies . We sincerely invite people who have dream,aspire,unwilling to be ordinary to join in Done Power , and strive for the "100-year Done Power" corporate goal while achieving their own achievements.

We believe that with the joint efforts of all Done people, the future of Done Power will surely rise like the rising sun and glorious earth!

COMPANY HISTORY

2009

2009 zhongshan lighting electronics factory was established.

2010–2011

In 2011, building R&D, QC and PMC, and domestic sales team.

2012–2013

Successfully registered trade mark "DONE", identify brand operation strategy! new factory was built with construction area of 25000m²

2014–2015

In 2014, the company was renamed "zhongshan Done lighting technology co., LTD." building the overseas sales team.

In 2015, the first phase of Done lighting has completed, and factory moved to the new plant from guzhen. Company passed ISO 9001-2008.

In The Future

Done continuously expands investment on innovation, concentrate on high power led driver research and development, deeply plough the led driver market subdivision application.

2019-2021

DONE phase III industrial park starts building, R&D center and Verification Center are completed.

DONE listing stategic released, and introduce third-party to help brand upgrade.

2016-2018

In 2016, DONE passed the high-tech enterprise certification, and DONE phase II plant started construction.

In 2017, the second phase of the plant will be completed and newly settled in the SMT, cable processing and high-power production workshop, which will provide a strong boost for the second take-off of DONE.

In 2018, DONE established Shenzhen operation center and Ningbo operation center, and formally entered the shenzhen and ningbo market.

ENTERPRISE SCENE

Focus on high power led
drivers



DONE



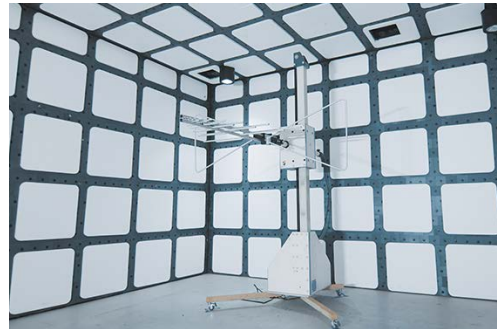

HONOR



BIS



CB



CCC



CE



EAC

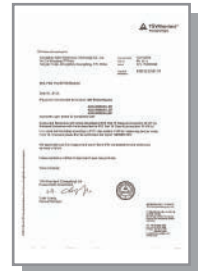

FCC



ISO



PSE



SAA



C-TICK



TUV



UL

GLOBAL PROFESSIONAL LED DRIVER BRAND FOR OUTDOOR LIGHTING

Project Lighting / Road Lighting / Plant Lighting
Smart Lighting / Industrial Lighting / Stadium lighting
Landscapes Lighting



CONTENT

Outdoor Municipal/Road/Tunnel Lighting Application Series

MXG 120-277V Outdoor Road Lighting LED Driver Series	01
MXL 100-277V Global Outdoor Road Lighting LED Driver Series	02
MXC 200-277V GB/EUR Outdoor Road Lighting LED Driver Series	03
MUG 277-480V Ultra High Voltage Outdoor Road Lighting LED Driver Series	04
MDK 120-277V GB/EUR Outdoor Road Lighting LED Driver Series	05
<hr/>	
MAS 200-277V GB/EUR Outdoor Road Lighting LED Driver Series	06-07
MAP 100-277V GB/EUR Outdoor Road Lighting LED Driver Series	08
MAL 100-277V EUR/US Standard Outdoor Road Lighting LED Driver Series	09
MAC 100-277V GB/EUR Outdoor Road Lighting LED Driver Series	10
MCC 100-240V Low Power Plastic Case Waterproof LED Driver Series	11-12
<hr/>	
PXS 100-277V Global Outdoor Road Lighting LED Driver Series	13
PXC 200-277V GB/EUR Outdoor Road Lighting LED Driver Series	14

Plant/Stadium Lighting Application Series

P XK 200-480V Ultra High Power Stadium Lighting LED Driver Series	15
MXS 120-277V Plant Lighting LED Driver Series	16
MXG 120-277V Plant /Stadium Lighting LED Driver Series	17
MTG 120-277V North America class 2 standard LED Driver series	18
PLS 120-277V Plant Lighting LED Driver Series	19

Intelligent Dimming Series

MXK AC200-277V Intelligent Road Lighting Series	20
D-MXG 120-277V DALI Auxiliary LED driver	21
C-MAS 200-277V European Standard Double Color Temperature Dimming LED driver	22
R-MAK 200-277V Input RS485 Communication LED driver	23
PXG 100-277V DALI Dimming LED driver Series	24
PXL 100-277V IP65 DALI Dimming LED driver Series	25

Industrial/Special Lighting Application Series

MCK 120-277V Non-isolated Linear Industrial Lighting LED Driver Series	26
PXG Global Non-Isolated Linear Industrial Lighting LED Driver Series	27-28
SPF 120-277V Global Non-Isolated Industrial Lighting LED Driver Series	29
PXL Global Non-Isolated Industrial Lighting LED Driver Series	30
SBS 100-277V GB/EUR Explosion-proof Lighting LED Driver Series	31

Constant Voltage Lighting Application Series

RXG outdoor waterproof constant voltage LED driver series	32-34
RXL Constant Voltage Linear Led Driver	35
RXC Waterproof CQC Certificated Constant Voltage Led Driver	36
RAB AC200-240V rainproof constant voltage LED driver series	37
RAC AC100-240V rainproof PFC constant voltage LED driver series	38
RAP AC100-240V Waterproof CLASS II Constant Voltage LED Driver	39
RAS Waterproof CLASS II Dimming Constant Voltage Led Driver	40

LED Driver Accessories: Surge Protection Device/ LED Driver Programmer	41-42
--	-------

MXG
PRODUCT FAMILY SERIES

MXG (30-320W)

120-277V Outdoor Road Lighting LED Driver Series



PRODUCT FEATURES

CE / CCC / SAA /  / FC / CLASS P

1. Rated input voltage:120-277V.
2. Provide standard output voltage version:25-56Vdc,Constant power voltage@36-56Vdc.
3. Provide high output voltage and low current version,Current range:0.7~1.05A.
4. Efficiency up to 94%/High PF \geq 0.95/THD \leq 10%.
5. Surge protection:6/15KV, Protection level: IP67.
6. SCP/OTP/OVP/OCV/UVI protection.
7. Life time>70,000 hrs.And 5 years warranty.

Type A:adjustable potentiometer version

Type P: programming version

Type X: programming auxiliary output

Type K: Class II version

	Model	Rated power	Input Voltage	Output Voltage	Constant power voltage	Output Current	Efficiency	Power Factor (230V)	Lightning protection rating	Product Size
30W	DL-30W-V56A/P/X-MXG	10-30W	120-277V	25-56V	30-56V	0.3-1A	89%	0.95	6KV/15KV	110*63*32mm
50W	DL-50W/WK-V56A/P/X-MXG	50W	120-277V	25-56V	30-56V	0.6-1.7A	89%	0.95	6KV/15KV	110*63*32mm
	DL-50W/WK-V72A/P/X-MXG	50W	120-277V	36-72V	48-72V	0.5-1.05A	89%	0.95	6KV/15KV	110*63*32mm
75W	DL-75W/WK-V56A/P/X-MXG	75W	120-277V	25-56V	36-56V	0.9-2.3A	89%	0.95	6KV/15KV	138*63*32mm
	DL-75W/WK-V108A/P/X-MXG	75W	120-277V	54-108V	72-108V	0.5-1.05A	90%	0.95	6KV/15KV	138*63*32mm
100W	DL-100W/WK-V56A/P/X/J-MXG	100W	120-277V	25-56V	36-56V	1.3-2.8A	89.5%	0.95	6KV/15KV	153*63*32mm
	DL-100W/WK-V143A/P/X/J-MXG	100W	120-277V	71-143V	95-143V	0.5-1.05A	91%	0.95	6KV/15KV	153*63*32mm
150W	DL-150W/WK-V56A/P/X/J-MXG	150W	120-277V	25-56V	36-56V	1.8-4.2A	92%	0.95	6KV/15KV	186*63*32mm
	DL-150W/WK-V214A/P/X/J-MXG	150W	120-277V	95-214V	143-214V	0.5-1.05A	93%	0.95	6KV/15KV	186*63*32mm
200W	DL-200W/WK-V56A/P/X/J-MXG	200W	120-277V	25-56V	36-56V	2.6-5.6A	92%	0.95	6KV/15KV	199*63*37mm
	DL-200W/WK-V286A/P/X/J-MXG	200W	120-277V	143-286V	190-286V	0.5-1.05A	93.5%	0.95	6KV/15KV	199*63*37mm
240W	DL-240W/WK-V56A/P/X/J-MXG	240W	120-277V	25-56V	36-56V	3.5-6.7A	92%	0.95	6KV/15KV	217*63*37mm
	DL-240W/WK-V343A/P/X/J-MXG	240W	120-277V	171-343V	228-343V	0.5-1.05A	94%	0.95	6KV/15KV	217*63*37mm
320W	DL-320W-V56X/J-MXG	320W	120-277V	25-56V	42-56V	4.2-7.65A	93.5%	0.97	6KV/15KV	244*83*40mm
	DL-320W-V428X/J-MXG	320W	120-277V	228-428V	304-428V	0.75-1.05A	93.5%	0.97	6KV/15KV	244*83*40mm

W is rated for 120-277V wide voltage input version. WK is CLASS II version, only have Type P.

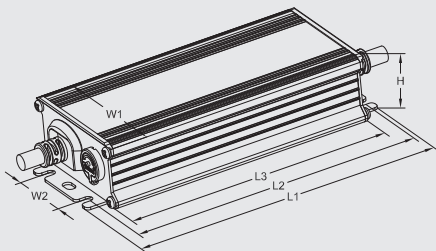

	Product Size					
	L1	L2	L3	W1	W2	H
30W	110mm	106mm	98mm	63mm	32mm	32mm
50W	110mm	106mm	98mm	63mm	32mm	32mm
75W	138mm	128mm	117mm	63mm	32mm	32mm
100W	153mm	143mm	132mm	63mm	32mm	32mm
150W	186mm	176mm	165mm	63mm	32mm	32mm
200W	199mm	189mm	178mm	63mm	28mm	37mm
240W	217mm	207mm	196mm	63mm	28mm	37mm
320W	244mm	234mm	224mm	83mm	50mm	40mm

Input Cable

Ø8.2 SJOW 17AWG H05RN-F 1.0mm²x400mm

Output Cable

Ø7.7 SJOW 17AWG H05RN-F 1.0mm²x250mm

Dimming Cable

UL 21996 22AWGx270mm

MXL

100-277V Global Outdoor Road Lighting LED Driver Series



PRODUCT FEATURES

1. Rated input voltage:100-277V.
2. Provide standard output voltage version:25-56Vdc,Constant and adjustable power@36/42-56Vdc.
3. Efficiency up to 94%/High PF \geq 0.95/THD \leq 10%.
4. Surge protection:30-60W 4/6KV, 75-320W 6/15KV, Protection level: IP67.
5. SCP/OTP/OVP protection
6. Life time>70,000 hrs.And 5 years warranty.

	Model	Rated power	Input Voltage	Output Voltage	Constant powervoltage	Output Current	Efficiency	Power Factor (230V)	Lightning protection rating	Product Size
75W	DL-75Z-56A/P-MXL	75W	100-277V	25-56V	36-56V	0.85-2.1A	90%	0.95	6KV/15KV	105*63*33mm
	DL-75Z-108A/P-MXL	75W	100-277V	54-108V	72-108V	0.5-1.05A	90%	0.95	6KV/15KV	105*63*33mm
100W	DL-100Z-V56A/P-MXL	100W	100-277V	25-56V	36-56V	1.3-2.8A	90%	0.95	6KV/15KV	146*63*33mm
	DL-100Z-V143A/P-MXL	100W	100-277V	71-143V	95-143V	0.5-1.05A	90%	0.95	6KV/15KV	146*63*33mm
150W	DL-150Z-V56A/P-MXL	150W	100-277V	25-56V	36-56V	1.7-4.2A	92%	0.95	6KV/15KV	166*63*33mm
	DL-150Z-V214A/P-MXL	150W	100-277V	95-214V	143-214V	0.5-1.05A	92%	0.95	6KV/15KV	166*63*33mm
200W	DL-200Z-V56A/P-MXL	200W	100-277V	25-56V	36-56V	2.6-5.6A	93%	0.95	6KV/15KV	186*63*37mm
	DL-200Z-V286A/P-MXL	200W	100-277V	143-286V	190-286V	0.5-1.05A	93%	0.95	6KV/15KV	186*63*37mm
240W	DL-240Z-V56A/P-MXL	240W	100-277V	25-56V	36-56V	3.5-6.7A	94%	0.95	6KV/15KV	186*63*37mm
	DL-240Z-V343A/P-MXL	240W	100-277V	171-343V	228-343V	0.5-1.05A	94%	0.95	6KV/15KV	186*63*37mm
320W	DL-320Z-V56A/P-MXL	320W	100-277V	25-56V	42-56V	4.2-7.65A	94%	0.97	6KV/15KV	244*63*37mm
	DL-320Z-V428A/P-MXL	320W	100-277V	228-428V	304-428V	0.7-1.05A	94%	0.97	6KV/15KV	244*63*37mm

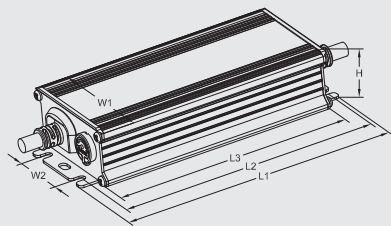

	Product Size					
	L1	L2	L3	W1	W2	H
75W	105mm	95mm	85mm	63mm	32mm	32mm
100W	146mm	136mm	126mm	63mm	32mm	32mm
150W	166mm	156mm	146mm	63mm	32mm	32mm
200W	186mm	176mm	166mm	63mm	28mm	37mm
240W	186mm	176mm	166mm	63mm	28mm	37mm
320W	244mm	234mm	224mm	83mm	50mm	40mm

Type A : adjustable potentiometer version

Type P : programming version

Input Cable

Ø2 SJOW 17AWG H05RN-F 1.0mm²x400mm

Output Cable

Ø2.7 SJOW 17AWG H05RN-F 1.0mm²x250mm

Dimming Cable

UL 21996 22AWGx270mm

Protection Level **IP67**

CE / CCC / CLASS P / UL / FC

MXC

100-277V GB/EUR Outdoor Road Lighting LED Driver Series



CE / CB / CCC / ENEC / SAA

PRODUCT FEATURES

1. Input: rated voltage 100~277V, Full Power Voltage 200~277V.
2. Output: 25-56V/0.7-1.05A, constant power 30-56V/0.5-1.05A.
3. Efficiency up to 94%/High PF \geq 0.95/ THD \leq 10%@ Low THD interference.
4. Surge protection: 4/6KV above 100W 6/15KV.
5. Protection level: IP67
6. SCP/OTP/OVP/UVF protection.
7. Life time>50,000 hrs.And 5 years warranty.

Type P: programming version

	Model	Rated power	Input Voltage	Output Voltage	Constant power voltage	Output Current	Efficiency	Power Factor (230V)	Lightning protection rating	Product Size
40W	DL-40H-56A/P-MXC	40W	200-277V	25-56V	30-56V	0.35-1.34A	89%	0.95	4/6KV	105*63*30mm
50W	DL-50H-56A/P-MXC	50W	200-277V	25-56V	30-56V	0.4-1.7A	89%	0.95	4/6KV	105*63*30mm
	DL-50H-72A/P-MXC	50W	200-277V	36-72V	48-72V	0.5-1.05A	89%	0.95	4/6KV	105*63*30mm
60W	DL-60H-56A/P-MXC	60W	200-277V	25-56V	30-56V	0.715-2A	89%	0.95	4/6KV	105*63*30mm
75W	DL-75H-56A/P-MXC	75W	200-277V	25-56V	36-56V	0.85-2.1A	90%	0.95	4/6KV	105*63*30mm
	DL-75H-108A/P-MXC	75W	200-277V	54-108V	72-108V	0.5-1.05A	90%	0.95	4/6KV	105*63*30mm
100W	DL-100H-56A/P-MXC	100W	200-277V	25-56V	36-56V	1.3-2.5A	91%	0.95	6/15KV	105*63*30mm
	DL-100H-143A/P-MXC	100W	200-277V	71-143V	95-143V	0.5-1.05A	91%	0.95	6/15KV	105*63*30mm
150W	DL-150H-56A/P-MXC	150W	200-277V	25-56V	36-56V	1.7-4.2A	93%	0.95	6/15KV	164*53*31mm
	DL-150H-214A/P-MXC	150W	200-277V	95-214V	143-214V	0.5-1.05A	93%	0.95	6/15KV	164*53*31mm
200W	DL-200H-56A/P-MXC	200W	200-277V	25-56V	36-56V	2.6-5.6A	93.5%	0.95	6/15KV	186*60*37mm
	DL-200H-286A/P-MXC	200W	200-277V	143-286V	190-286V	0.5-1.05A	93.5%	0.95	6/15KV	186*60*37mm
240W	DL-240H-56A/P-MXC	240W	200-277V	25-56V	36-56V	3.5-6.7A	94%	0.95	6/15KV	186*60*37mm
	DL-240H-343A/P-MXC	240W	200-277V	171-343V	228-343V	0.5-1.05A	94%	0.95	6/15KV	186*60*37mm
320W	DL-320H-56A/P-MXC	320W	200-277V	25-56V	42-56V	4.2-7.65A	94%	0.95	6/15KV	230*67*38mm
	DL-320H-428A/P-MXC	320W	200-277V	228-428V	304-428V	0.7-1.05A	94%	0.95	6/15KV	230*67*38mm

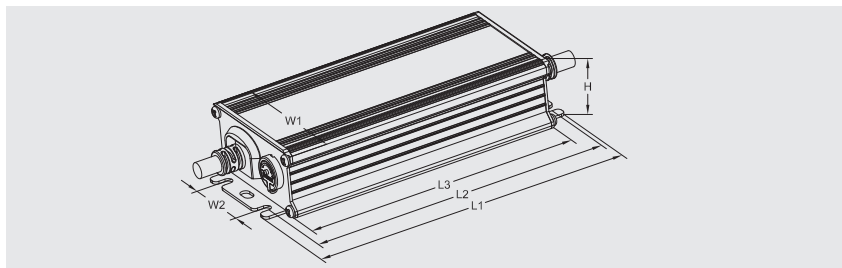

	Product Size					
	L1	L2	L3	W1	W2	H
50W	105mm	95mm	90mm	63mm	32mm	30mm
75W	105mm	95mm	90mm	63mm	32mm	30mm
100W	105mm	128mm	117mm	63mm	32mm	30mm
150W	164mm	143mm	132mm	63mm	32mm	31mm
200W	186mm	176mm	165mm	63mm	32mm	37mm
240W	186mm	176mm	165mm	63mm	28mm	37mm

Input Cable
Ø7.2 H05RN-F 1.0mm²x400mm

Output Cable
Ø6.8 H05RN-F 1.0mm²x300mm

Dimming Cable
UL2517 22AWGx270mm

MUG

277-480V Ultra High Voltage Outdoor Road Lighting LED Driver Series



CE / cULus / FC / CLASS P

Type P: programming version

1. Rated input voltage: 277~480Vac.
2. Output voltage:25-56V,constant power voltage:36-56V.
3. Provide high output voltage and low current version,Current range:0.7~1.05A.
4. High efficiency up to 96%/Power factor 0.95/THD<10%.
5. Surge protection:6KV/10KV.
6. Protection level: IP67.
7. SCP/OTP/OVP/OVP/UVP protection function.
8. Life time>50,000 hrs.And 5 years warranty.

	Model	Rated power	Input Voltage	Output Voltage	Constant power voltage	Output Current	Efficiency	Power Factor (230V)	Lightning protection rating	Product Size
100W	DL-100U-V56P-MUG	100W	277-480V	25-56V	36-56V	0.8-2.8A	90%	0.97	6KV/10KV	200*68*37mm
	DL-100U-V143P-MUG	100W	277-480V	47-143V	95-143V	0.7-1.05A	90%	0.97	6KV/10KV	200*68*37mm
150W	DL-150U-V56P-MUG	150W	277-480V	25-56V	36-56V	1.7-4.2A	91%	0.97	6KV/10KV	200*68*37mm
	DL-150U-V214P-MUG	150W	277-480V	95-214V	143-214V	0.7-1.05A	91%	0.97	6KV/10KV	200*68*37mm
240W	DL-240U-V56P-MUG	240W	277-480V	25-56V	36-56V	2.6-6.7A	92%	0.97	6KV/10KV	230*68*37mm
	DL-240U-V343P-MUG	240W	277-480V	142-343V	228-343V	0.7-1.05A	92%	0.97	6KV/10KV	230*68*37mm
320W	DL-320U-V56P-MUG	320W	277-480V	25-56V	36-56V	4.2-9.0A	93%	0.97	6KV/10KV	245*83*40mm
	DL-320U-V428P-MUG	320W	277-480V	228-428V	304-428V	0.7-1.05A	93%	0.97	6KV/10KV	245*83*40mm
600W	DL-600U-56P-MUG	600W	277-480V	25-56V	46-56V	7.1-13A	95%	0.97	6KV/10KV	280*130*44mm
	DL-600U-428P-MUG	600W	277-480V	276-428V	357-428V	0.93-1.68A	95%	0.97	6KV/10KV	280*130*44mm
800W	DL-800U-56P-MUG	800W	277-480V	25-56V	46-56V	10.7-17.4A	96%	0.97	6KV/10KV	310*130*44mm
	DL-800U-428P-MUG	800W	277-480V	222-428V	296-428V	1.4-2.7A	96%	0.97	6KV/10KV	310*130*44mm

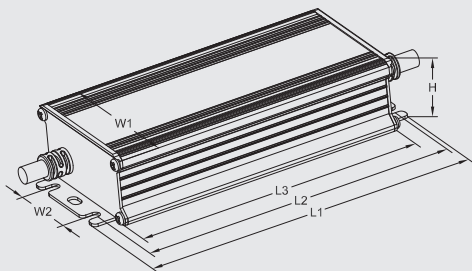

Product Size

	L1	L2	L3	W1	W2	H
100W	200mm	190mm	180mm	68mm	36mm	37mm
150W	200mm	190mm	180mm	68mm	36mm	37mm
240W	230mm	220mm	210mm	68mm	36mm	37mm
320W	245mm	235mm	225mm	83mm	50mm	40mm
600W	280mm	269mm	258mm	130mm	100mm	44mm
800W	310mm	299mm	288mm	130mm	100mm	44mm

Input Cable
Ø9.4 SOW 18AWGx400mm

Output Cable
Ø7.7 SJOW 17AWG H05RN-F 1.0mm²x250mm

Dimming Cable
UL2517 22AWGx270mm

MDK

120-277V GB/EUR Outdoor Road Lighting LED Driver Series



PRODUCT FEATURES

CE / CCC / SAA / cULus / FC / CLASS P

1. Rated input voltage:120-277Vac.
2. Output voltage:25-56V,constant power voltage:36-56V.
3. Provide high output voltage and low current version,Current range:0.7~1.05A.
4. Efficiency up to 94%/High PF \geq 0.95/THD \leq 10%@230VAC Low THD interference.
5. Surge protection:6KV/10KV.
6. Protection level: IP42.
7. SCP/OTP/OVP/UVI protection.
8. Life time>50,000 hrs.And 5 years warranty.

Type P : programming version

Type A :adjustable potentiometer version

Type X : programming auxiliary output version

	Model	Rated power	Input Voltage	Output Voltage	Constant power voltage	Output Current	Efficiency	Power Factor (230V)	Lightning protection rating	Product Size
30W	DL-30W-V56A/P/X-MDK	30W	120-277V	25-56V	30-56V	0.33-1A	88%	0.95	6KV/10KV	119*57*32mm
50W	DL-50W-V56A/P/X-MDK	50W	120-277V	25-56V	30-56V	0.6-1.7A	89%	0.95	6KV/10KV	119*57*32mm
	DL-50W-V72A/P/X-MDK	50W	120-277V	36-72V	48-72V	0.5-1.05A	89%	0.95	6KV/10KV	119*57*32mm
75W	DL-75W-V56A/P/X-MDK	75W	120-277V	25-56V	30-56V	0.9-2.3A	90%	0.95	6KV/10KV	138*57*32mm
	DL-75W-V108A/P/X-MDK	75W	120-277V	54-108V	72-108V	0.5-1.05A	90%	0.95	6KV/10KV	138*57*32mm
100W	DL-100W-V56A/P/X-MDK	100W	120-277V	25-56V	36-56V	1.3-2.8A	89.5%	0.95	6KV/10KV	153*57*32mm
	DL-100W-V143A/P/X-MDK	100W	120-277V	71-143V	95-143V	0.5-1.05A	91%	0.95	6KV/10KV	153*57*32mm
150W	DL-150W-V56A/P/X-MDK	150W	120-277V	25-56V	36-56V	1.8-4.2A	93%	0.95	6KV/10KV	186*63*32mm
	DL-150W-V214A/P/X-MDK	150W	120-277V	95-214V	143-214V	0.5-1.05A	93%	0.95	6KV/10KV	186*63*32mm
200W	DL-200W-V56A/P/X-MDK	200W	120-277V	25-56V	36-56V	2.6-5.6A	93.5%	0.95	6KV/10KV	199*57*37mm
	DL-200W-V286A/P/X-MDK	200W	120-277V	143-286V	190-286V	0.5-1.05A	93.5%	0.95	6KV/10KV	199*57*37mm
240W	DL-240W-V56A/P/X-MDK	240W	120-277V	25-56V	36-56V	3.5-6.7A	94%	0.95	6KV/10KV	217*57*37mm
	DL-240W-V343A/P/X-MDK	240W	120-277V	171-343V	228-343V	0.5-1.05A	94%	0.95	6KV/10KV	217*57*37mm

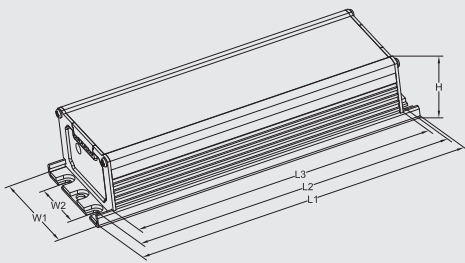

Product Size

	L1	L2	L3	W1	W2	H
30W	119mm	111mm	102mm	57mm	32mm	32mm
50W	119mm	111mm	102mm	57mm	32mm	32mm
75W	138mm	130mm	121mm	57mm	32mm	32mm
100W	153mm	145mm	136mm	57mm	32mm	32mm
150W	186mm	178mm	169mm	63mm	32mm	32mm
200W	199mm	191mm	181mm	57mm	32mm	37mm
240W	217mm	209mm	200mm	57mm	32mm	37mm

Input Cable
UL1015 18AWG \varnothing 2.8 x200mm

Output Cable
UL1015 18AWG \varnothing 2.8 x200mm

Dimming Cable
UL1015 22AWG x220mm

MAS

MAS
PRODUCT FAMILY SERIES

200-277V GB/EUR Outdoor Road Lighting LED Driver Series



PRODUCT FEATURES

1. Rated input voltage:200-277V.
2. Output voltage:20-38Vdc/32-58Vdc , Constant power voltage:32-38Vdc/42-58Vdc.
3. Provide high output voltage and low current version,Current voltage:0.7~1.05A.
4. Efficiency up to 91%/High PF \geq 0.95/THD \leq 10%@230VAC Low THD interference.
5. Surge protection:30-75W: 4/6KV, 100W and above: 6/15KV.
6. Protection level: IP67.
7. SCP/OTP/OVP/UVF protection.
8. Life time>50,000 hrs.And 5 years warranty.

Type A :adjustable potentiometer version

Type P : programming version

	Model	Rated power	Input Voltage	Output Voltage	Constant powervoltage	Output Current	Efficiency	Power Factor (230V)	Lightning protection rating	Product Size
30W	DL-30H-V38A/P-MAS	30W	200-277V	20~38V	32-38V	0.3-1A	89%	0.95	4KV/6KV	98*51.5*30mm
	DL-30H-V58A/P-MAS	30W	200-277V	32~58V	42-58V	0.2-0.75A	89%	0.95	4KV/6KV	98*51.5*30mm
50W	DL-50H-V38A/P-MAS	50W	200-277V	20~38V	32-38V	0.7-1.6A	89%	0.95	4KV/6KV	108*51.5*30mm
	DL-50H-V58A/P-MAS	50W	200-277V	32~58V	42-58V	0.5-1.2A	89%	0.95	4KV/6KV	108*51.5*30mm
	DL-50H-V72A/P-MAS	50W	200-277V	36~72V	48-72V	0.5-1.05A	89%	0.95	4KV/6KV	108*51.5*30mm
75W	DL-75H-V38A/P-MAS	75W	200-277V	20~38V	32-38V	1.3-2.5A	89%	0.95	4KV/6KV	137*56.5*34mm
	DL-75H-V58A/P-MAS	75W	200-277V	32~58V	42-58V	0.9-1.8A	89%	0.95	4KV/6KV	137*56.5*34mm
	DL-75H-V108A/P-MAS	75W	200-277V	54-108V	72-108V	0.5-1.05A	89%	0.95	4KV/6KV	137*56.5*34mm
100W	DL-100H-V38A/P-MAS	100W	200-277V	20~38V	32-38V	1.9-3.5A	90%	0.95	6KV/15KV	151*56.5*34mm
	DL-100H-V58A/P-MAS	100W	200-277V	32~58V	42-58V	1.3-2.5A	90%	0.95	6KV/15KV	151*56.5*34mm
	DL-100H-V150A/P-MAS	100W	200-277V	71~150V	95-150V	0.5-1.05A	90%	0.95	6KV/15KV	151*56.5*34mm
150W	DL-150H-V38A/P-MAS	150W	200-277V	20-38V	32-38V	2.8-5A	91%	0.95	6KV/15KV	175*66.5*34mm
	DL-150H-V58A/P-MAS	150W	200-277V	32-58V	42-58V	1.8-3.6A	91%	0.95	6KV/15KV	175*66.5*34mm
	DL-150H-V214A/P-MAS	150W	200-277V	95-214V	143-214V	0.5-1.05A	91%	0.95	6KV/15KV	175*66.5*34mm
200W	DL-200H-V38A/P-MAS	200W	200-277V	20-38V	32-38V	3.7-6.3A	91%	0.95	6KV/15KV	215*66.5*34mm
	DL-200H-V58A/P-MAS	200W	200-277V	32-58V	42-58V	2.4-4.8A	91%	0.95	6KV/15KV	215*66.5*34mm
	DL-200H-V286A/P-MAS	200W	200-277V	143-286V	190-286V	0.5-1.05A	91%	0.95	6KV/15KV	215*66.5*34mm
240W	DL-240H-V38A/P-MAS	240W	200-277V	20-38V	32-38V	5.2-7.5A	91%	0.95	6KV/15KV	225*71.5*34mm
	DL-240H-V58A/P-MAS	240W	200-277V	32-58V	42-58V	3.4-5.8A	91%	0.95	6KV/15KV	225*71.5*34mm
	DL-240H-V343A/P-MAS	240W	200-277V	171-343V	228-343V	0.5-1.05A	91%	0.95	6KV/15KV	225*71.5*34mm

Indian standard EESL(440V) OVP LED driver series

30W	DL-30I-V38A/P-MAS	30W	200-277V	20~38V	32-38V	0.3-1A	89%	0.9	4KV/6KV	98*51.5*30mm
	DL-30I-V58A/P-MAS	30W	200-277V	32~58V	42-58V	0.2-0.75A	89%	0.9	4KV/6KV	98*51.5*30mm
50W	DL-50I-V38A/P-MAS	50W	200-277V	20~38V	32-38V	0.7-1.6A	89%	0.9	4KV/6KV	118*51.5*30mm
	DL-50I-V58A/P-MAS	50W	200-277V	32~58V	42-58V	0.5-1.2A	89%	0.9	4KV/6KV	118*51.5*30mm
	DL-50I-V72A/P-MAS	50W	200-277V	36~72V	48-72V	0.5-1.05A	89%	0.9	4KV/6KV	118*51.5*30mm
75W	DL-75I-V38A/P-MAS	75W	200-277V	20~38V	32-38V	1.3-2.5A	90%	0.9	4KV/6KV	137*56.5*34mm
	DL-75I-V58A/P-MAS	75W	200-277V	32~58V	42-58V	0.9-1.8A	90%	0.9	4KV/6KV	137*56.5*34mm
	DL-75I-V108A/P-MAS	75W	200-277V	54-108V	72-108V	0.5-1.05A	90%	0.9	4KV/6KV	137*56.5*34mm
100W	DL-100I-V38A/P-MAS	100W	200-277V	20~38V	32-38V	1.9-3.5A	91%	0.9	6KV/15KV	151*56.5*34mm
	DL-100I-V58A/P-MAS	100W	200-277V	32~58V	42-58V	1.3-2.5A	91%	0.9	6KV/15KV	151*56.5*34mm
	DL-100I-V150A/P-MAS	100W	200-277V	71~150V	95-150V	0.5-1.05A	91%	0.9	6KV/15KV	151*56.5*34mm
150W	DL-150I-V38A/P-MAS	150W	200-277V	20-38V	32-38V	2.8-5A	91%	0.9	6KV/15KV	175*66.5*34mm
	DL-150I-V58A/P-MAS	150W	200-277V	32-58V	42-58V	1.8-3.6A	91%	0.9	6KV/15KV	175*66.5*34mm
	DL-150I-V214A/P-MAS	150W	200-277V	95-214V	143-214V	0.5-1.05A	91%	0.9	6KV/15KV	175*66.5*34mm
200W	DL-200I-V38A/P-MAS	200W	200-277V	20-38V	32-38V	3.7-6.3A	91%	0.9	6KV/15KV	215*66.5*34mm
	DL-200I-V58A/P-MAS	200W	200-277V	32-58V	42-58V	2.4-4.8A	91%	0.9	6KV/15KV	215*66.5*34mm
	DL-200I-V286A/P-MAS	200W	200-277V	143-286V	190-286V	0.5-1.05A	91%	0.9	6KV/15KV	215*66.5*34mm
240W	DL-240I-V38A/P-MAS	240W	200-277V	20-38V	32-38V	5.2-7.5A	91%	0.9	6KV/15KV	225*71.5*34mm
	DL-240I-V58A/P-MAS	240W	200-277V	32-58V	42-58V	3.4-5.8A	91%	0.9	6KV/15KV	225*71.5*34mm
	DL-240I-V343A/P-MAS	240W	200-277V	171-343V	228-343V	0.5-1.05A	91%	0.9	6KV/15KV	225*71.5*34mm

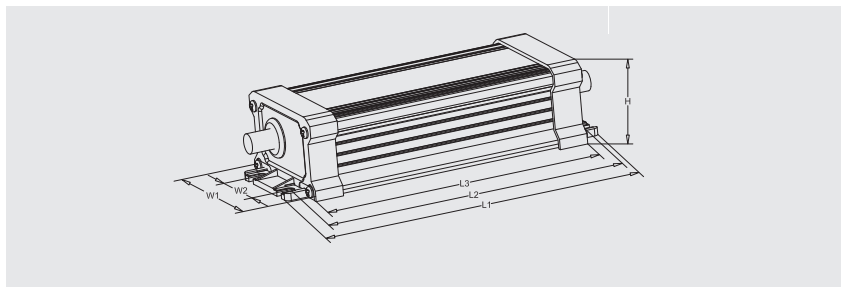

	Product Size					
	L1	L2	L3	W1	W2	
30W	98mm	94mm	88mm	51.5mm	24mm	30mm
50W	108mm	104mm	98mm	51.5mm	24mm	30mm
75W	137mm	128mm	119mm	56.5mm	26mm	34mm
100W	151mm	142mm	133mm	56.5mm	26mm	34mm
150W	175mm	165mm	157mm	66.5mm	36mm	34mm
200W	215mm	206mm	197mm	66.5mm	36mm	34mm
240W	225mm	216mm	207mm	71.5mm	41mm	34mm

Input Cable
Ø7.2 H05RN-F 1.0mm²x400mm

Output Cable
Ø6.8 H05RN-F 1.0mm²x250mm

Dimming Cable
UL2517 22AWGx270mm

Protection Level **IP67**

CE / CB / CCC / SAA / EN

MAP

100-277V GB/EUR Outdoor Road Lighting LED Driver Series



PRODUCT FEATURES

CE / CB / CCC / SAA /  / 

1. Rated input voltage:100-277Vac,derated protection@100~180Vac.
2. Output voltage:20-38Vdc/32-58Vdc , Constant and adjustable power@32-38Vdc/42-58Vdc.
3. Efficiency up to 91%/High PF>0.95/THD<10%.
4. Surge protection:50-75W: 4/6KV, 100W and above: 6/15KV.
5. Protection level: IP67.
6. SCP/OTP/OVP/UVP protection.
7. Life time>50,000 hrs.And 5 years warranty.

Type A: adjustable potentiometer version

Type S: three in one dimming version

	Model	Rated power	Input Voltage	Output Voltage	Constant powervoltage	Output Current	Efficiency	Power Factor (230V)	Lightning protection rating	Product Size
50W	DL-50W-V38A/S-MAP	50W	100-277V	20-38V	32-38V	0.7-1.6A	87.5%	0.95	4KV/6KV	126*41*29mm
	DL-50W-V58A/S-MAP	50W	100-277V	32-58V	42-58V	0.5-1.2A	88%	0.95	4KV/6KV	126*41*29mm
75W	DL-75W-V38A/S-MAP	75W	100-277V	20-38V	32-38V	1.3-2.5A	88%	0.95	4KV/6KV	143*49*31mm
	DL-75W-V58A/S-MAP	75W	100-277V	32-58V	42-58V	0.9-1.8A	88%	0.95	4KV/6KV	143*49*31mm
105W	DL-105W-V38A/S-MAP	105W	100-277V	20-38V	32-38V	1.9-3.5A	90.5%	0.95	6KV/15KV	164*53*32.5mm
	DL-105W-V58A/S-MAP	105W	100-277V	32-58V	42-58V	1.3-2.5A	91.6%	0.95	6KV/15KV	164*53*32.5mm
150W	DL-150W-V38A/S-MAP	150W	100-277V	20-38V	32-38V	2.8-5A	90.5%	0.95	6KV/15KV	186*60*38mm
	DL-150W-V58A/S-MAP	150W	100-277V	32-58V	42-58V	1.8-3.6A	91.5%	0.95	6KV/15KV	186*60*38mm
200W	DL-200W-V38A/S-MAP	200W	100-277V	20-38V	32-38V	3.7-6.7A	90%	0.95	6KV/15KV	230*67*38mm
	DL-200W-V58A/S-MAP	200W	100-277V	32-58V	42-58V	2.4-4.8A	91%	0.95	6KV/15KV	230*67*38mm

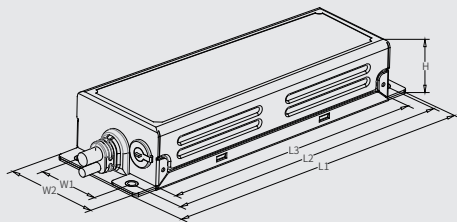

Product Size

	L1	L2	L3	W1	W2	H
50W	126mm	116mm	106mm	26.5mm	41mm	29mm
75W	143mm	130.5mm	118mm	34mm	49mm	31mm
100W	164mm	150mm	136mm	34mm	53mm	32.5mm
150W	186mm	173.5mm	160mm	36mm	60mm	38mm
200W	230mm	217.4mm	202mm	44.8mm	67mm	38mm

Input Cable
Ø7.2 H05RN-F 1.0mm²x400mm

Output Cable
Ø6.8 H05RN-F 1.0mm²x300mm

Dimming Cable
UL2517 22AWGx270mm

MAL

100-277 EUR/US Standard Outdoor Road Lighting LED Driver Serie

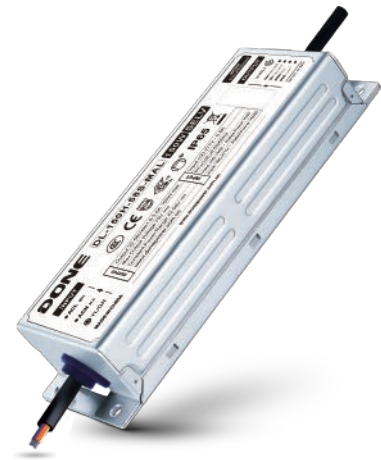

PRODUCT FEATURES

CE / CB / CCC / SAA / UL / ENEC

1. Rate input voltage : Z version:100-277Vac; H version: 200-277Vac.
2. Output: 32-58V, constant power 42-58V.
3. Efficiency up to 92%/High PF \geq 0.95/ THD \leq 10%@ Low THD interference.
4. Surge protection:4/6KV 6/15KV.
5. Protection level: IP67.
6. SCP/OTP/OVP/UVF protection.
7. Life time>50,000 hrs.And 5 years warranty

Type S: three in one dimming version

	Model	Rated power	Input Voltage	Output Voltage	Constant power voltage	Output Current	Efficiency	Power Factor (230V)	Lightning protection rating	Product Size
20W	DL-20Z-58A/S-MAL	20W	100-277V	32~58V	42-58V	0.17-0.48A	88%	0.95	4/6KV	100*41*27mm
30W	DL-30Z-58A/S-MAL	30W	100-277V	32~58V	42-58V	0.35-0.715A	89%	0.95	4/6KV	100*41*27mm
40W	DL-40Z-58A/S-MAL	40W	100-277V	32~58V	42-58V	0.52-0.96A	89%	0.95	4/6KV	126*41*29mm
50W	DL-50Z-58A/S-MAL	50W	100-277V	32~58V	42-58V	0.52-1.2A	89%	0.95	4/6KV	126*41*29mm
60W	DL-60Z-58A/S-MAL	60W	100-277V	32~58V	42-58V	0.86-1.43A	89%	0.95	4/6KV	126*41*29mm

200-277V Input

40W	DL-40H-58A/S-MAL	40W	200-277V	32~58V	42-58V	0.52-0.96A	89%	0.95	4/6KV	100*41*27 mm
50W	DL-50H-58A/S-MAL	50W	200-277V	32~58V	42-58V	0.52-1.2A	89%	0.95	4/6KV	126*41*29mm
60W	DL-60H-58A/S-MAL	60W	200-277V	32~58V	42-58V	0.86-1.43A	89%	0.95	4/6KV	126*41*29mm
75W	DL-75H-58A/S-MAL	75W	200-277V	32~58V	42-58V	0.86-1.8A	89%	0.95	4/6KV	126*41*29mm
100W	DL-100H-58A/S-MAL	100W	200-277V	32~58V	42-58V	1.3-2.4A	91%	0.95	6/15KV	143*49*31mm
150W	DL-150H-58A/S-MAL	150W	200-277V	32~58V	42-58V	1.73-3.6A	91%	0.95	6/15KV	176*57*32mm
200W	DL-200H-58A/S-MAL	200W	200-277V	32~58V	42-58V	2.59-4.8A	92%	0.95	6/15KV	186*60*38mm

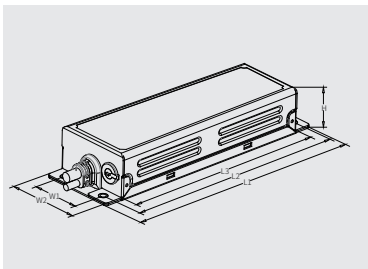

	Product Size							Product Size					
	L1	L2	L3	W1	W2	H		L1	L2	L3	W1	W2	H
40W	100mm	90mm	80mm	31mm	41mm	27mm	20/30W	100mm	90mm	80mm	26.5mm	41mm	27mm
50/60W	126mm	116mm	106mm	31mm	41mm	29mm	40/50W	126mm	116mm	106mm	26.5mm	41mm	29mm
75W	126mm	116mm	106mm	31mm	41mm	29mm	60W	126mm	116mm	106mm	26.5mm	41m	29mm
100W	143mm	133mm	123mm	39mm	49mm	31mm							
150W	176mm	166mm	156mm	47mm	57mm	32mm							
200W	186mm	173.5mm	160mm	36mm	60mm	38mm							

Input Cable
Ø7.2 H05RN-F 1.0mm²x400mm

Output Cable
Ø6.8 H05RN-F 1.0mm²x300mm

Dimming Cable
UL2517 22AWGx270mm

MAC

100-277V GB/EUR Outdoor Road Lighting LED Driver Series



CCC / CB

PRODUCT FEATURES

1. Rated input voltage: 100-277V.
2. Output: constant current output
3. Efficiency up to 90%/High PF \geq 0.95/ THD \leq 10%@ Low THD interference.
4. Surge protection: 6KV.
5. Protection level: IP65.
6. UVP/SCP/OTP/OVP protection.
7. Life time>50,000 hrs.And 5 years warranty

	Model	Rated power	Input Voltage	Output Voltage	Output Current	Efficiency	Power Factor (230V)	Lightning protection rating	Product Size
30W	DL-30Z-C600-MAC	30W	100-277V	25-50V	600mA	88%	0.95	6KV	92*35*26mm
	DL-30Z-C750-MAC	30W	100-277V	20-42V	750mA	88%	0.95	6KV	92*35*26mm
	DL-30Z-C900-MAC	30W	100-277V	20-36V	900mA	88%	0.95	6KV	92*35*26mm
50W	DL-50Z-C900-MAC	50W	100-277V	25-56V	900mA	90%	0.95	6KV	108*35*26 mm
	DL-50Z-C1050-MAC	50W	100-277V	25-50V	1050mA	90%	0.95	6KV	108*35*26 mm
	DL-50Z-C1200-MAC	50W	100-277V	20-38V	1200mA	90%	0.95	6KV	108*35*26 mm
	DL-50Z-C1350-MAC	50W	100-277V	20-38V	1350mA	90%	0.95	6KV	108*35*26 mm
	DL-50Z-C1500-MAC	50W	100-277V	20-36V	1500mA	90%	0.95	6KV	108*35*26 mm

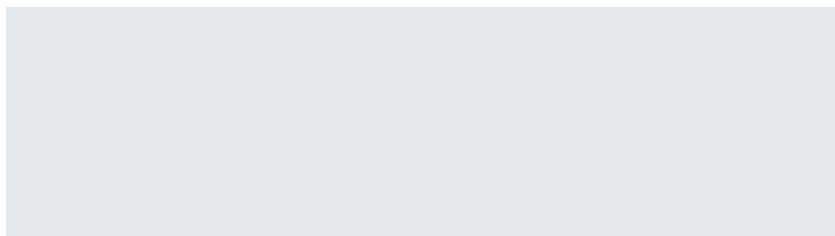

	Product Size					
	L1	L2	L3	W1	W2	H
30W	92mm	-mm	-mm	35mm	-mm	26mm
50W	108mm	-mm	-mm	35mm	-mm	26mm

Input Cable
UL1015 18#AWG Ø2.8

MCC

Mini built-in pastic housing waterproof LED Driver



PRODUCT FEATURES

1. Rated input voltage:100-240V.
2. Efficiency up to 86%/High PF>0.95/THD<10%.
3. Surge protection:2KV.
4. Protection level: IP65.
5. SCP/OVP/OC protection.
6. Life time>50,000 hrs.And 5 years warranty.

	Model	Rated power	Input Voltage	Output Voltage	Output Current	Efficiency	Power Factor (230V)	Lightning protection rating	Product Size
3W	DL-3W-C150-MCC	1.65W	100-240V	5-11V	150mA	75%	0.9	2KV	52*30*22mm
	DL-3W-C180-MCC	1.98W	100-240V	5-11V	180mA	75%	0.9	2KV	52*30*22mm
	DL-3W-C210-MCC	2.31W	100-240V	5-11V	210mA	75%	0.9	2KV	52*30*22mm
	DL-3W-C240-MCC	2.64W	100-240V	5-11V	240mA	75%	0.9	2KV	52*30*22mm
	DL-3W-C270-MCC	2.97W	100-240V	5-11V	270mA	75%	0.9	2KV	52*30*22mm
	DL-3W-C300-MCC	3.3W	100-240V	5-11V	300mA	75%	0.9	2KV	52*30*22mm
	DL-3W-C350-MCC	3.85W	100-240V	5-11V	350mA	75%	0.9	2KV	52*30*22mm
	DL-3W-C500-MCC	3W	100-240V	2-6V	500mA	75%	0.9	2KV	52*30*22mm
	DL-3W-C600-MCC	3.6W	100-240V	2-6V	600mA	75%	0.9	2KV	52*30*22mm
DL-3W-C700-MCC	4.2W	100-240V	2-6V	700mA	75%	0.9	2KV	52*30*22mm	
7W	DL-7W-C150-MCC	3.6W	100-240V	11-24V	150mA	80%	0.9	2KV	52*30*22mm
	DL-7W-C180-MCC	4.32W	100-240V	11-24V	180mA	80%	0.9	2KV	52*30*22mm
	DL-7W-C210-MCC	5.04W	100-240V	11-24V	210mA	80%	0.9	2KV	52*30*22mm
	DL-7W-C240-MCC	5.76W	100-240V	11-24V	240mA	80%	0.9	2KV	52*30*22mm
	DL-7W-C270-MCC	6.48W	100-240V	11-24V	270mA	80%	0.9	2KV	52*30*22mm
	DL-7W-C300-MCC	7.2W	100-240V	11-24V	300mA	80%	0.9	2KV	52*30*22mm
	DL-7W-C350-MCC	7W	100-240V	10-20V	350mA	80%	0.9	2KV	52*30*22mm
	DL-7W-C500-MCC	6.5W	100-240V	6-13V	500mA	80%	0.9	2KV	52*30*22mm
	DL-7W-C600-MCC	6W	100-240V	5-10V	600mA	80%	0.9	2KV	52*30*22mm
DL-7W-C700-MCC	7W	100-240V	5-10V	700mA	80%	0.9	2KV	52*30*22mm	
12W	DL-12W-C210-MCC	8.82W	100-240V	21-42V	210mA	83%	0.95	2KV	70*36*23mm
	DL-12W-C240-MCC	10.08W	100-240V	21-42V	240mA	83%	0.95	2KV	70*36*23mm
	DL-12W-C270-MCC	11.34W	100-240V	21-42V	270mA	83%	0.95	2KV	70*36*23mm
	DL-12W-C300-MCC	12.6W	100-240V	21-42V	300mA	83%	0.95	2KV	70*36*23mm
	DL-12W-C350-MCC	14.7W	100-240V	21-42V	350mA	83%	0.95	2KV	70*36*23mm
	DL-12W-C500-MCC	12.5W	100-240V	11-25V	500mA	83%	0.95	2KV	70*36*23mm
	DL-12W-C600-MCC	13.2W	100-240V	11-22V	600mA	83%	0.95	2KV	70*36*23mm
	DL-12W-C700-MCC	14W	100-240V	11-20V	700mA	83%	0.95	2KV	70*36*23mm

20W	DL-20W-C300-MCC	20.4W	100-240V	36-68V	300mA	85%	0.95	2KV	70*36*23mm
	DL-20W-C350-MCC	20.3W	100-240V	36-58V	350mA	85%	0.95	2KV	70*36*23mm
	DL-20W-C400-MCC	16.8W	100-240V	21-42V	400mA	85%	0.95	2KV	70*36*23mm
	DL-20W-C450-MCC	18.9W	100-240V	21-42V	450mA	85%	0.95	2KV	70*36*23mm
	DL-20W-C500-MCC	20.5W	100-240V	21-41V	500mA	85%	0.95	2KV	70*36*23mm
	DL-20W-C600-MCC	20.4W	100-240V	21-34V	600mA	85%	0.95	2KV	70*36*23mm

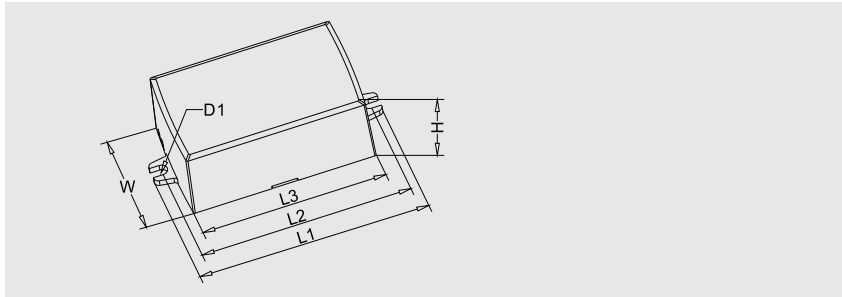

Product Size						
	L1	L2	L3	D1	W	H
3W	52mm	46.5mm	39.5mm	3.8mm	30mm	22mm
7W	52mm	46.5mm	39.5mm	3.8mm	30mm	22mm
12W	70mm	64mm	57.5mm	3.8mm	36mm	23mm
20W	70mm	64mm	57.5mm	3.8mm	36mm	23mm

Input Cable
 UL1672 20#AWG Ø2.8 / **Output Cable**
 UL1569 22#AWG Ø 1.6

Protection Level **IP65**

CE / CCC / SAA / EN



PXS

Non-isolated Offline Programming waterproof LED Driver



PRODUCT FEATURES

CE / CB / SAA /  /  / FC / CLASS P

1. Rate input voltage : W version:120-277Vac; V version: 220-480Vac.
2. 180-260V high output voltage, constant and adjustable power within the range of 200-260V output voltage
3. Efficiency up to 95%/High PF \geq 0.95/THD \leq 10%@ Low THD interference
4. Surge protection: 6/15KV.
5. Protection level: IP67.
6. SCP/OTP/OVP protection.
7. Life time>50,000 hrs.And 5 years warranty.

DX type : DALI dimming + auxiliary source

Type X programming auxiliary output version

	Model	Rated power	Input Voltage	Output Voltage	Constant powervoltage	Output Current	Efficiency	Power Factor (230V)	Lightning protection rating	Product Size
40W	DL-40Z-260X-PXS	40W	100-277V	180-260V	200-260V	0.08-0.2A	93%	0.97	6/15KV	105*63*33mm
60W	DL-60Z-260X-PXS	60W	100-277V	180-260V	200-260V	0.12-0.3A	93%	0.97	6/15KV	105*63*33mm
80W	DL-80Z-260X-PXS	60W	100-277V	180-260V	200-260V	0.23-0.4A	93.5%	0.97	6/15KV	105*63*33mm
100W	DL-100Z-260X/DX-PXS	100W	100-277V	180-260V	200-260V	0.28-0.5A	94.5%	0.97	6/15KV	105*63*33mm
	DL-100V-260X-PXS	100W	200-480V	180-260V	200-260V	0.28-0.5A	94.5%	0.97	6/15KV	105*63*33mm
150W	DL-150Z-260X/DX-PXS	150W	100-277V	180-260V	200-260V	0.38-0.75A	94.5%	0.97	6/15KV	140*63*33mm
	DL-150V-260X-PXS	150W	200-480V	180-260V	200-260V	0.38-0.75A	94.5%	0.97	6/15KV	140*63*33mm
200W	DL-200Z-260X/DX-PXS	200W	100-277V	180-260V	200-260V	0.57-1A	94.5%	0.97	6/15KV	165*63*33mm
	DL-200V-260X-PXS	200W	200-480V	180-260V	200-260V	0.57-1A	94.5%	0.97	6/15KV	165*63*33mm
240W	DL-240Z-260X/DX-PXS	240W	100-277V	180-260V	200-260V	0.75-1.25A	95.5%	0.97	6/15KV	165*63*33mm
	DL-240V-260X-PXS	240W	200-480V	180-260V	200-260V	0.75-1.25A	95.5%	0.97	6/15KV	165*63*33mm
320W	DL-320Z-260X-PXS	320W	100-277V	180-260V	200-260V	0.92-1.6A	95.5%	0.97	6/15KV	185*63*33mm
	DL-320V-260X-PXS	320W	200-480V	180-260V	200-260V	0.92-1.6A	95.5%	0.97	6/15KV	185*63*33mm

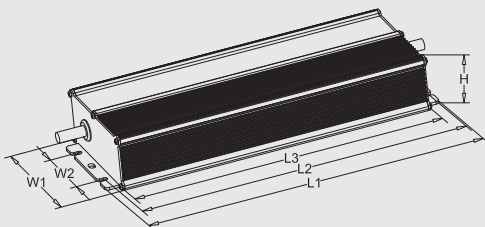

Product Size

	L1	L2	L3	W1	W2	H
60W	105mm	95mm	85mm	63mm	32mm	32mm
100W	105mm	95mm	85mm	63mm	32mm	32mm
150W	140mm	130mm	120mm	63mm	32mm	32mm
240W	165mm	155mm	145mm	63mm	28mm	37mm

Input Cable
 \varnothing 7.2 H05RN-F 1.0mm²x400mm

Output Cable
 \varnothing 6.8 H05RN-F 1.0mm²x250mm
 \varnothing 7.6 H05RN-F 1.5mm²x250mm

PXC

European Standard Non-isolated Offline Programming Waterproof LED Driver



CE / CB / CCC / SAA

PRODUCT FEATURES

1. Input: Rated input voltage 200~277V
2. Output: 180-260V, constant power voltage 200-260V.
3. Efficiency up to 95%/High PF \geq 0.95/THD \leq 7%@ Low THD interference.
4. Surge protection:6/10KV.
5. Protection level: IP65.
6. SCP/OTP/OVP protection.
7. Life time>50,000 hrs.And 5 years warranty

P version: offline programming

	Model	Rated power	Input Voltage	Output Voltage	Constant power voltage	Output Current	Efficiency	Power Factor (230V)	Lightning protection rating	Product Size
40W	DL-40H-260A/P-PXC	40W	200-277V	180-260V	200-260V	0.08-0.2A	93%	0.97	6/10KV	126*41*29mm
50W	DL-50H-260A/P-PXC	50W	200-277V	180-260V	200-260V	0.1-0.25A	93%	0.97	6/10KV	126*41*29mm
60W	DL-60H-260A/P-PXC	60W	200-277V	180-260V	200-260V	0.115-0.3A	93%	0.97	6/10KV	126*41*29mm
75W	DL-75H-260A/P-PXC	75W	200-277V	180-260V	200-260V	0.19-0.38A	94%	0.97	6/10KV	126*41*29mm
100W	DL-100H-260A/P-PXC	100W	200-277V	180-260V	200-260V	0.28-0.5A	94.5%	0.97	6/10KV	143*49*31mm
120W	DL-120H-260A/P-PXC	120W	200-277V	180-260V	200-260V	0.38-0.6A	94.5%	0.97	6/10KV	143*49*31mm
150W	DL-150H-260A/P-PXC	150W	200-277V	180-260V	200-260V	0.38-0.75A	94.5%	0.97	6/10KV	143*49*31mm
200W	DL-200H-260A/P-PXC	200W	200-277V	180-260V	200-260V	0.58-1.05A	95%	0.97	6/10KV	164*53*32.5mm
240W	DL-240H-260A/P-PXC	240W	200-277V	180-260V	200-260V	0.75-1.25A	95.5%	0.97	6/10KV	164*53*32.5mm
320W	DL-320H-260A/P-PXC	320W	200-277V	180-260V	200-260V	0.92-1.6A	95.5%	0.97	6/10KV	176*57*32mm

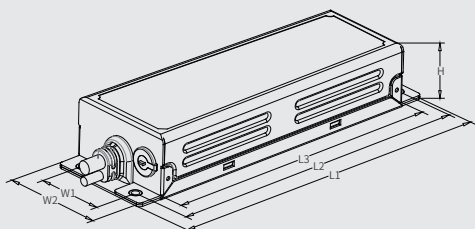

Product Size

	L1	L2	L3	W1	W2	H
40/50W	126mm	116mm	106mm	26.5mm	41mm	29mm
60/75W	126mm	116mm	106mm	26.5mm	41mm	29mm
100W	143mm	130.5mm	118mm	34mm	49mm	31mm
120W	143mm	130.5mm	118mm	34mm	49mm	31mm
150W	143mm	130.5mm	118mm	34mm	49mm	31mm
200W	164mm	150mm	136mm	34mm	53mm	31mm
240W	164mm	150mm	136mm	34mm	53mm	31mm
320W	176mm	162mm	148mm	38mm	57mm	32mm

Input Cable
Ø7.2 H05RN-F 1.0mm²x400mm

Output Cable
Ø6.8 H05RN-F 1.0mm²x300mm

Dimming Cable
UL2517 22AWGx270mm

PXK

200-480V Ultra High Power Stadium Lighting LED Driver Series



PRODUCT FEATURES

CB / CE / SAA /  /  / FC / 

1. Rated input voltage:200~480Vac.
2. 260-500V high output voltage, constant and adjustable power with in the range of 334-500V output voltage.
3. Efficiency up to 97%/High PF \geq 0.99/THD \leq 7% Low THD interference.
4. Surge protection:10KV/10KV IK08.
5. Protection level: IP66.
6. UVP/SCP/OTP/OVP /UVP protection.
7. Life time>50,000 hrs.And 5 years warranty.

	Model	Rated power	Input Voltage	Output Voltage	Constant powervoltage	Output Current	Efficiency	Power Factor (230V)	Lightning protection rating	Product Size
1500W	DL-1500V-500EGM-PXK	1500W	200-480V	260-500V	334-500V	1.0-1.5*3A	96%	0.99	10KV/10KV	500*150*90mm
1800W	DL-1800V-500EGM-PXK	1800W	200-480V	260-500V	334-500V	1.2-1.8*3A	97%	0.99	10KV/10KV	500*150*90mm

	Product Size					
	L1	L2	L3	W1	W2	H
1500W	500mm	490mm	480mm	150mm	130mm	90mm
1800W	500mm	490mm	480mm	150mm	130mm	90mm

EGM type : (three outputs + DALI 2 & D4I + NTC + DMX512 & RDM)

Input Cable
UL1015 18AWG Ø2.8 x200mm

Output Cable
UL1015 18AWG Ø2.8 x200mm

Dimming Cable
UL1015 22AWGx220mm

MXS

120-277V Plant Lighting LED Driver Series



PRODUCT FEATURES

CB / CCC / CE / UL / SAA / eUL / FC / CLASS P / RoHS / REACH / WEEE

1. Rated input voltage:120-277V.
2. Output voltage: 25-56Vdc , constant power voltage: 36/46-56V.
3. Efficiency up to 96%/High PF \geq 0.97/THD \leq 10%.
4. Surge protection:6/15KV.
5. Protection level: IP67.
6. SCP/OTP/OVP/UVF protection.
7. Life time>80,000 hrs.And 8 years warranty.

Type GX: DALI 2.0&D4I and NFC and programming auxiliary output

Type Y+X: 2 way output and programming auxiliary output version

Type E+X: 3 way output and programming auxiliary output version

	Model	Rated power	Input Voltage	Output Voltage	Constant power voltage	Output Current	Efficiency	Power Factor (230V)	Lightning protection rating	Product Size
680W	DL-680W-56X-MXS	680W	120-277V	36-56V	46-56V	8.9-14.8A	95.5%	0.97	6KV/15KV	330*90*48mm
800W	DL-800W-V56X-MXS	800W	120-277V	36-56V	46-56V	10.7-17.4A	96%	0.97	6KV/15KV	396*90*48mm
1000W	DL-1000W-V56X-MXS	1000W	120-277V	36-56V	46-56V	14.3-21.75A	96%	0.97	6KV/15KV	360*90*48mm
1200W	DL-1200W-V220X-MXS	1200W	120-277V	150-220V	160-220V	4-7.5A	96%	0.97	6KV/15KV	315*130*48mm
	DL-1200W-56X-MXS	1200W	120-277V	36-56V	46-56V	10.7-26.1A	96%	0.97	6KV/15KV	440*95*48 mm
1600W	DL-1600W-56X-MXS	1600W	120-277V	36-56V	46-56V	21.4-34.8A	96.5%	0.97	6KV/15KV	480*90*48mm

Three-way Output

Model	Passageway	Rated power	Input Voltage	Output Voltage	Constant power voltage	Output Current	Efficiency	Power Factor (230V)	Lightning protection rating	Product Size
DL-1000WE-V56X-MXS	Full Power Channel CH1	500-800W	120-277V	36-56V	46-56V	9-17.4A	96%	0.97	6KV/15KV	310*130*45mm
	Channel CH1	500-700W	120-277V	36-56V	46-56V	9-15.2A	96%	0.97	6KV/15KV	310*130*45mm
	Channel CH2	100-200W	120-277V	36-56V	36-56V	1.8-5.5A	94.5%	0.97	6KV/15KV	310*130*45mm
	Channel CH3	70-100W	120-277V	36-56V	36-56V	1.25-2.8A	94.5%	0.97	6KV/15KV	310*130*45mm

Two-way Output

Model	Passageway	Rated power	Input Voltage	Output Voltage	Constant power voltage	Output Current	Efficiency	Power Factor (230V)	Lightning protection rating	Product Size
DL-1000WY-V56X-MXS	Full Power Channel CH1	680-1000W	120-277V	35-56V	46-56V	12.1-21.75A	96%	0.97	6KV/15KV	310*130*45mm
	Channel CH1	680-900W	120-277V	35-56V	46-56V	12.1-19.6A	96%	0.97	6KV/15KV	310*130*45mm
	Channel CH2	70-100W	120-277V	35-56V	36-56V	1.25-2.8A	94.5%	0.97	6KV/15KV	310*130*45mm

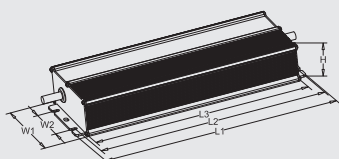

Product Size

	L1	L2	L3	W1	W2	H
800W	305mm	294mm	283mm	90mm	60mm	48mm
1000W	360mm	349mm	338mm	90mm	60mm	48mm
1200W	310mm	299mm	288mm	90mm	60mm	48mm

Input Cable

Ø8.2 SJOW 17AWG H05RN-F 1.0mm²x400mm

Output Cable

Ø7.7 SJOW 17AWG H05RN-F 1.0mm²x250mm
Ø9.0 SJOW 14AWGx250mm

Dimming Cable

UL21996 22AWGx270mm

MXG (400-750W)

MXG
PRODUCT FAMILY SERIES

120-277V Plant /Stadium Lighting LED Driver Series



PRODUCT FEATURES

CB / CCC / CE / UL / SAA / UL1875 / FC / CLASS P / RoHS / REACH

1. Rated input voltage:120-277V.
2. Provide standard output voltage version:25-56Vdc,Constant power@46-56Vdc.
3. compatible with DALI 2.0 fuction module, NTC function optional, and conventional outlet and built-in dimmer two configurations are optional.
4. Efficiency up to 96%/High PF \geq 0.97/THD \leq 7%.
5. Surge protection:6/15KV.
6. Protection level: IP67.
7. SCP/OTP/OVP/OCP/UVp protection.
8. Life time>70,000 hrs.And 5 years warranty.

Type X: programming auxiliary output version

NTC external over temperature protection version

	Model	Rated power	Input Voltage	Output Voltage	Constant power voltage	Output Current	Efficiency	Power Factor (230V)	Lightning protection rating	Product Size
400W	DL-400W-V56X-MXG	320-400W	120-277V	25-56V	46-56V	5.7-8.7A	94.5%	0.97	6KV/15KV	245*83*40mm
	DL-400W-V428X-MXG	320-400W	120-277V	228-428V	286-428V	0.75-1.4A	94.5%	0.97	6KV/15KV	245*83*40mm
500W	DL-500W-V56X-MXG	400-500W	120-277V	25-56V	46-56V	5.7-10.8A	94%	0.97	6KV/15KV	266*95*44mm
	DL-500W-V428X-MXG	400-500W	120-277V	228-428V	357-428V	1.15-1.4A	94%	0.97	6KV/15KV	266*95*44mm
600W	DL-600W-V56X-MXG	400-600W	120-277V	25-56V	46-56V	7.1-13A	95%	0.97	6KV/15KV	280*130*45mm
	DL-600W-V428X-MXG	400-600W	120-277V	276-428V	357-428V	1.4-1.75A	95%	0.97	6KV/15KV	280*130*45mm
680W	DL-680W-V56X-MXG	500-680W	120-277V	25-56V	46-56V	8.9-16.2A	95%	0.97	6KV/15KV	396*95*44mm
	DL-680W-V389X-MXG	500-680W	120-277V	238-389V	285-389V	1.75-2.1A	95%	0.97	6KV/15KV	396*95*44mm
720W	DL-720W-V56X-MXG	650-750W	120-277V	25-56V	46-56V	10.7-15.7A	95%	0.97	6KV/15KV	310*130*45mm
	DL-720W-V428X-MXG	650-750W	120-277V	285-343V	357-428V	1.4-2.1A	95%	0.97	6KV/15KV	310*130*45mm
750W	DL-750W-V56X-MXG	650-750W	120-277V	25-56V	46-56V	11.6-16.3A	96%	0.97	6KV/15KV	396*95*44mm
	DL-750W-V428X-MXG	650-750W	120-277V	323-428V	357-428V	1.75-2.1A	96%	0.97	6KV/15KV	396*95*44mm

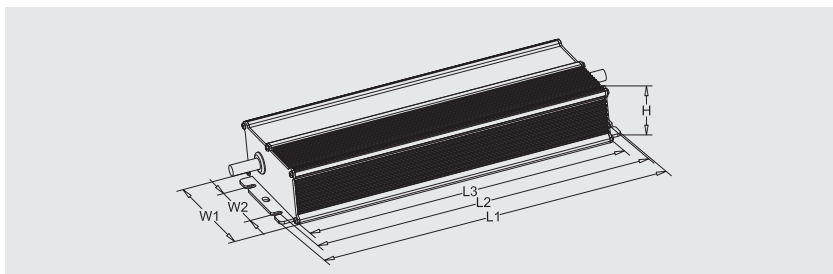

	Product Size					
	L1	L2	L3	W1	W2	H
400W	244mm	234mm	224mm	83mm	50mm	40mm
500W(X)	266mm	256mm	246mm	95mm	50mm	44mm
600W	280mm	269mm	258mm	130mm	97mm	45mm
680W(X)	396mm	386mm	376mm	95mm	50mm	44mm
720W	310mm	299mm	288mm	130mm	97mm	45mm
750W(X)	396mm	386mm	376mm	95mm	50mm	44mm

Input Cable
8 \varnothing SJOW 17AWG H05RN-F 1.0mm²x400mm

Output Cable
7.7 \varnothing SJOW 17AWG H05RN-F 1.0mm²x250mm
9.0 \varnothing SJOW 14AWGx250mm

Dimming Cable
UL21996 22AWGx270mm

MTG

120-277V North America class 2 standard LED Driver series



PRODUCT FEATURES

CE / SAA /  /  /  / FC / CLASS P

1. Rated input voltage:120-277Vac.
2. Output voltage:25-48Vdc.
3. Efficiency up to 90%/High PF \geq 0.95/THD \leq 10%@230VAC Low THD interference.
4. Surge protection:6KV/10KV.
5. Protection level: IP65.
6. SCP/OTP/OVP/UVI protection.
7. Life time>50,000 hrs.And 5 years warranty.

Type S: three in one dimming version

Type X: programming auxiliary output version

	Model	Rated power	Input Voltage	Output Voltage	Constant powervoltage	Output Current	Efficiency	Power Factor (230V)	Lightning protection rating	Product Size
30W	DL-30W-V48S/X-MTG	15-30W	120-277V	25-48V	30-48V	0.3-1A	85%	0.95	6KV/10KV	158*48*31.5mm
50W	DL-50W-V48S/X-MTG	30-50W	120-277V	25-48V	30-48V	0.6-1.67A	88.5%	0.95	6KV/10KV	158*48*31.5mm
75W	DL-75W-V48S/X-MTG	50-75W	120-277V	25-48V	30-48V	1.0-2.5A	89.5%	0.95	6KV/10KV	176*48*31.5mm
100W	DL-100W-V48S/X-MTG	75-100W	120-277V	25-48V	30-48V	1.5-3.4A	90%	0.95	6KV/10KV	206*48*31.5mm

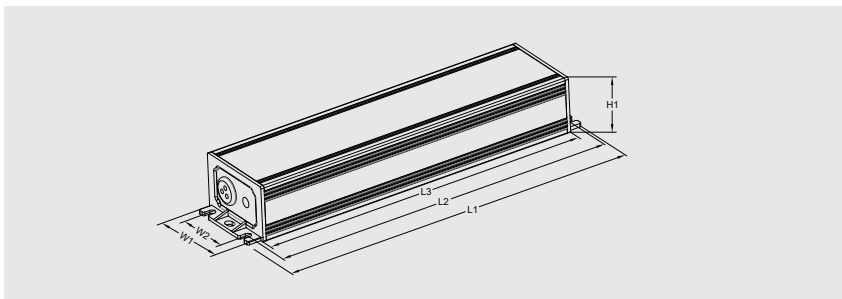

Product Size						
	L1	L2	L3	W1	W2	H
30W	157mm	149mm	141mm	48mm	32mm	31.5mm
50W	157mm	149mm	141mm	48mm	32mm	31.5mm
75W	175mm	167mm	159mm	48mm	32mm	31.5mm
100W	206mm	198mm	190mm	48mm	32mm	31.5mm

Input Cable
UL1015 18AWG \varnothing 2.8 x200mm

Output Cable
UL1015 18AWG \varnothing 2.8 x200mm

Dimming Cable
UL1015 22AWGx220mm

PLS

120-277V Plant Lighting LED Driver Series



PRODUCT FEATURES

CE / CCC / SAA / / UL / FC / CLASS P

1. Rate input voltage : W version:120-277Vac; V version: 220-480Vac .
2. Output voltage:180-260Vdc,constant power voltage range@200-260V.
3. Efficiency up to 97.5%/High PF \geq 0.97/THD \leq 7%@230VAC Low THD interference.
4. Surge protection:6/15KV.
5. Protection level: IP67.
6. SCP/OTP/OVP/UVF protection.
7. Life time>70,000 hrs.And 5 years warranty.

Type X: programming auxiliary output version

Type T: NTC external over temperature protection version

	Model	Rated power	Input Voltage	Output Voltage	Constant power voltage	Output Current	Efficiency	Power Factor (230V)	Lightning protection rating	Product Size
400W	DL-400W-V260X-PLS	400W	120-277V	180-260V	200-260V	1.2-2A	96%	0.97	6KV/15KV	234*63*40mm
500W	DL-500W-V260X-PLS	500W	120-277V	180-260V	200-260V	1.2-2.5A	97%	0.97	6KV/15KV	234*83*40mm
680W	DL-680W-V260X-PLS	680W	120-277V	180-260V	200-260V	1.9-3.4A	97%	0.97	6KV/15KV	246*95*45mm
800W	DL-800W-V260X-PLS	800W	120-277V	180-260V	200-260V	2.5-4.0A	97%	0.97	6KV/15KV	266*95*45mm
960W	DL-960W-V260X-PLS	960W	120-277V	180-260V	200-260V	3.0-4.8A	97%	0.97	6KV/15KV	316*95*45mm
1200W	DL-1200W-V260X-PLS	1200W	120-277V	180-260V	200-260V	3.7-6A	97.5%	0.97	6KV/15KV	310*130*48mm

220-480V Input

	Model	Rated power	Input Voltage	Output Voltage	Constant power voltage	Output Current	Efficiency	Power Factor (230V)	Lightning protection rating	Product Size
400W	DL-400W-V260X-PLS	400W	200-528V	180-260V	200-260V	1.2-2A	96%	0.97	6KV/15KV	234*63*40mm
500W	DL-500W-V260X-PLS	500W	220-480V	180-260V	200-260V	1.2-2.5A	97%	0.97	6KV/15KV	234*83*40mm
680W	DL-680W-V260X-PLS	680W	220-480V	180-260V	200-260V	1.9-3.4A	97%	0.97	6KV/15KV	246*95*45mm
800W	DL-800W-V260X-PLS	800W	220-480V	180-260V	200-260V	2.5-4.0A	97%	0.97	6KV/15KV	266*95*45mm
960W	DL-960W-V260X-PLS	960W	220-480V	180-260V	200-260V	3.0-4.8A	97%	0.97	6KV/15KV	316*95*45mm
1200W	DL-1200W-V260X-PLS	1200W	220-480V	180-260V	200-260V	3.7-6A	97.5%	0.97	6KV/15KV	310*130*48mm

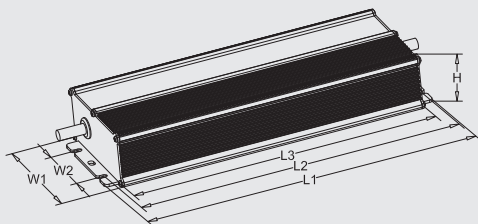

Product Size

	L1	L2	L3	W1	W2	H
400W	234mm	224mm	216mm	63mm	28mm	37mm
500W	234mm	224mm	216mm	83mm	50mm	40mm
680W	246mm	236mm	226mm	95mm	50mm	45mm
800W	266mm	256mm	246mm	95mm	50mm	45mm
960W	316mm	306mm	296mm	95mm	50mm	45mm
1200W	310mm	300mm	289mm	130mm	95mm	48mm

Input Cable

Ø8.2 SJOW 17AWG H05RN-F 1.0mm²x400mm

Output Cable

Ø SJOW 17AWG H05RN-F 1.0mm²x250mm

Dimming Cable

UL21996 22AWGx270mm

MXK

AC200-277V Intelligent Road Lighting Series



PRODUCT FEATURES

CB / CE / CCC / ENEC / SAA

1. Rated input voltage:200-277V.
2. Provide high output voltage and low current version,Current range:0.7~1.05A .
3. Efficiency up to 93.5%/High PF \geq 0.97/THD \leq 7%.
4. Surge protection:6/10KV.
5. Protection level: IP20.
6. SCP/OTP/OVP/UVF protection.
7. Life time>50,000 hrs.And 5 years warranty.

Type P: programmable version

Type GX: DALI 2.0&D4I and NFC and programming auxiliary output

Type X: programming auxiliary output

	Model	Rated power	Input Voltage	Output Voltage	Constant power voltage	Output Current	Efficiency	Power Factor (230V)	Lightning protection rating	Product Size
40W	DL-40H-V58P/X/GX-MXK	20~40W	200-277V	19-58V	38-58V	0.5-1.05A	89%	0.97	6KV/10KV	133*77*33mm
80W	DL-80H-V115P/X/GX-MXK	40~80W	200-277V	38-115V	76-115V	0.5-1.05A	90%	0.97	6KV/10KV	133*77*33mm
110W	DL-110H-V158P/X/GX-MXK	80~110W	200-277V	76-158V	105-158V	0.5-1.05A	91%	0.97	6KV/10KV	133*77*33mm
165W	DL-165H-V235P/X/GX-MXK	110~165W	200-277V	104-235V	157-236V	0.5-1.05A	93%	0.97	6KV/10KV	170*100*40mm
200W	DL-200H-V286P/X/GX-MXK	165~200W	200-277V	157-286V	190-286V	0.5-1.05A	93.5%	0.97	6KV/10KV	170*100*40mm

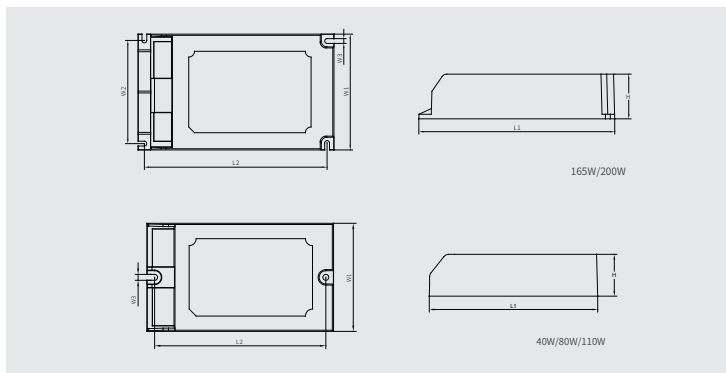

Product Size

	L1	L2	W1	W2	W3	H
40W	133mm	122mm	77mm	/	4.2mm	33mm
80W	133mm	122mm	77mm	/	4.2mm	33mm
110W	133mm	122mm	77mm	/	4.2mm	3mm
165W	170mm	160mm	100mm	100mm	-mm	40mm
200W	170mm	160mm	100mm	100mm	-mm	40mm

MXG
PRODUCT FAMILY SERIES

D-MXG

120-277V DALI Auxiliary LED driver



PRODUCT FEATURES

CE / CCC / UL / SAA / FC / CLASS P / RoHS

1. Rated input voltage:120-277V.
2. Output voltage:25-56Vdc,Constant and adjustable power@30/36-56Vdc.
3. Provide high output voltage and low current version,Current range:0.7~1.05A.
4. High efficiency up to 94%/Power factor 0.95/THD<10%.
5. Surge protection 6/15KV.
6. Protection level: IP67.
7. SCP/OTP/OVP/OVP/UVF protection function.
8. Life time>70,000 hrs.And 5 years warranty.

Type DX: DALI 2.0 and programming auxiliary output version

Type GX: DALI 2.0 and NFC and programming auxiliary output version

	Model	Rated power	Input Voltage	Output Voltage	Constant power voltage	Output Current	Efficiency	Power Factor (230V)	Lightning protection rating	Product Size
30W	DL-30W-V56DX-MXG	15-30W	120-277V	25-56V	30-56V	0.3-1A	89%	0.97	6KV/15KV	110*63*32mm
50W	DL-50W-V56DX/GX-MXG	25~50W	120-277V	25-56V	30-56V	0.6-1.7A	89%	0.97	6KV/15KV	110*63*32mm
	DL-50W-V72DX/GX-MXG	25~50W	120-277V	36-72V	48-72V	0.5-1.05A	89%	0.97	6KV/15KV	110*63*32mm
75W	DL-75W-V56DX/GX-MXG	50~75W	120-277V	25-56V	30-56V	0.9-2.3A	90%	0.97	6KV/15KV	138*63*32mm
	DL-75W-V108DX/GX-MXG	50~75W	120-277V	54-108V	72-108V	0.5-1.05A	90%	0.97	6KV/15KV	138*63*32mm
100W	DL-100W-V56DX/GX-MXG	75~100W	120-277V	25-56V	36-56V	1.3-2.8A	91%	0.97	6KV/15KV	153*63*32mm
	DL-100W-V143DX/GX-MXG	75~100W	120-277V	71-143V	95-143V	0.5-1.05A	91%	0.97	6KV/15KV	153*63*32mm
150W	DL-150W-V56DX/GX-MXG	100~150W	120-277V	25-56V	36-56V	1.8-4.2A	92%	0.97	6KV/15KV	186*63*32mm
	DL-150W-V214DX/GX-MXG	100~150W	120-277V	95-214V	143-214V	0.5-1.05A	92%	0.97	6KV/15KV	186*63*32mm
200W	DL-200W-V56DX/GX-MXG	150~200W	120-277V	25-56V	36-56V	2.6-5.6A	93.5%	0.97	6KV/15KV	199*63*37mm
	DL-200W-V286DX/GX-MXG	150~200W	120-277V	143-286V	190-286V	0.5-1.05A	93.5%	0.97	6KV/15KV	199*63*37mm
240W	DL-240W-V56DX/GX-MXG	200~240W	120-277V	25-56V	36-56V	3.5-6.7A	94%	0.97	6KV/15KV	217*63*37mm
	DL-240W-V343DX/GX-MXG	200~240W	120-277V	171-343V	228-343V	0.5-1.05A	94%	0.97	6KV/15KV	217*63*37mm

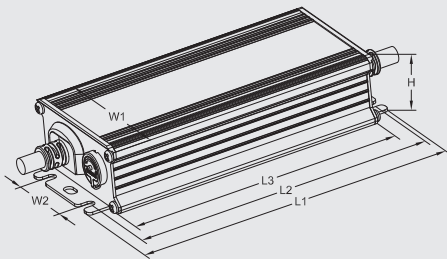

Product Size

	L1	L2	L3	W1	W2	H
30W	110mm	106mm	98mm	63mm	32mm	32mm
50W	110mm	106mm	98mm	63mm	32mm	32mm
75W	138mm	128mm	117mm	63mm	32mm	32mm
100W	153mm	143mm	132mm	63mm	32mm	32mm
150W	186mm	176mm	165mm	63mm	32mm	32mm
200W	199mm	189mm	178mm	63mm	28mm	37mm
240W	217mm	207mm	196mm	63mm	28mm	37mm

Input Cable

Ø8.2 SJOW 17AWG H05RN-F 1.0mm²x400mm

Output Cable

Ø7.7 SJOW 17AWG H05RN-F 1.0mm²x250mm

Dimming Cable

UL 21996 22AWGx270mm

C-MAS

MAS
PRODUCT FAMILY SERIES

200-277v European Standard Double Color Temperature Dimming LED driver



PRODUCT FEATURES

1. Rated input voltage:200-277V.
2. Output voltage:20-38Vdc/32-58Vdc , Constant power voltage:32-38Vdc/42-58Vdc.
3. Efficiency up to 90%/High PF \geq 0.95/THD \leq 10%@230VAC Low THD interference.
4. Surge protection:50-75W: 4/6KV, 100W and above: 6/15KV.
5. Protection level: IP65.
6. SCP/OTP/OVP/UVF protection.
7. Life time>50,000 hrs.And 5 years warranty.

Type C: Two color temperature version

	Model	Rated power	Input Voltage	Output Voltage	Constant power voltage	Output Current	Efficiency	Power Factor (230V)	Lightning protection rating	Product Size
30W	DL-30H-V38C-MAS	30W	200-277V	20-38V	32-38V	0.3-1A	87%	0.95	4KV/6KV	108*51.5*30mm
	DL-30H-V58C-MAS	30W	200-277V	32-58V	42-58V	0.2-0.75A	87%	0.95	4KV/6KV	108*51.5*30mm
50W	DL-50H-V38C-MAS	50W	200-277V	20-38V	32-38V	0.7-1.6A	87%	0.95	4KV/6KV	118*51.5*30mm
	DL-50H-V58C-MAS	50W	200-277V	32-58V	42-58V	0.5-1.2A	88%	0.95	4KV/6KV	118*51.5*30mm
75W	DL-75H-V38C-MAS	75W	200-277V	20-38V	32-38V	1.3-2.5A	89%	0.95	4KV/6KV	147*56.5*34mm
	DL-75H-V58C-MAS	75W	200-277V	32-58V	42-58V	0.9-1.8A	89%	0.95	4KV/6KV	147*56.5*34mm
100W	DL-100H-V38C-MAS	100W	200-277V	20-38V	32-38V	1.9-3.5A	90%	0.95	6KV/15KV	161*56.5*34mm
	DL-100H-V58C-MAS	100W	200-277V	32-58V	42-58V	1.3-2.5A	90%	0.95	6KV/15KV	161*56.5*34mm
150W	DL-150H-V38C-MAS	150W	200-277V	20-38V	32-38V	2.8-5A	90%	0.95	6KV/15KV	185*66.5*34mm
	DL-150H-V58C-MAS	150W	200-277V	32-58V	42-58V	1.8-3.6A	90%	0.95	6KV/15KV	185*66.5*34mm
200W	DL-200H-V58C-MAS	200W	200-277V	32-58V	42-58V	2.6-4.8A	90%	0.95	6KV/15KV	225*66.5*34mm
240W	DL-240H-V58C-MAS	240W	200-277V	32-58V	42-58V	3.5-5.7A	90%	0.95	6KV/15KV	235*66.5*34mm

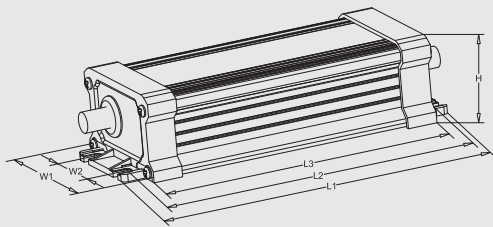

Product Size

	L1	L2	L3	W1	W2	H
30W	108mm	104mm	98mm	51.5mm	24mm	30mm
50W	118mm	114mm	108mm	51.5mm	24mm	30mm
75W	147mm	138mm	129mm	56.5mm	26mm	34mm
100W	161mm	152mm	143mm	56.5mm	26mm	34mm
150W	185mm	175mm	165mm	66.5mm	36mm	34mm
200W	225mm	210mm	205mm	66.5mm	36mm	34mm
240W	235mm	225mm	215mm	66.5mm	36mm	34mm

Input Cable
Ø7.2 H05RN-F 1.0mm²x400mm

Output Cable
Ø7.2 H05RN-F 1.0mm²x250mm

Dimming Cable
UL 21996 22AWGx270mm

R-MAK

200-277V Input RS485 Communication LED driver



CE / CB / CCC

PRODUCT FEATURES

1. Rated input voltage:200-277V.
2. Output voltage:32-58Vdc , Constant power range: 42-58Vdc.
3. Efficiency up to 91%/High PF \geq 0.95/THD \leq 10%@Low THD interference.
4. Surge protection: 4/6KV、 6/15KV
5. Protection level: IP67.
6. UVP/SCP/OTP/OVP /UVP protection.
7. Life time>50,000 hrs.And 5 years warranty.

	Model	Rated power	Input Voltage	Output Voltage	Constant power voltage	Output Current	Efficiency	Power Factor (230V)	Lightning protection rating	Product Size
30W	DL-30H-58R-MAK	30W	200-277V	32-58V	42-58V	0.2-0.75A	88%	0.95	4KV/6KV	110*63*33mm
	DL-30H-58CR-MAK	30W	200-277V	32-58V	42-58V	0.2-0.75A	88%	0.95	4KV/6KV	110*63*33mm
50W	DL-50H-58R-MAK	50W	200-277V	32-58V	42-58V	0.5-1.2A	88%	0.95	4KV/6KV	110*63*33mm
	DL-50H-58CR-MAK	50W	200-277V	32-58V	42-58V	0.5-1.2A	88%	0.95	4KV/6KV	110*63*33mm
75W	DL-75H-58R-MAK	75W	200-277V	32-58V	42-58V	0.9-1.8A	90%	0.95	4KV/6KV	153*63*33mm
	DL-75H-58CR-MAK	75W	200-277V	32-58V	42-58V	0.9-1.8A	90%	0.95	4KV/6KV	153*63*33mm
100W	DL-100H-R-MAK	100W	200-277V	32-58V	42-58V	1.3-2.5A	90%	0.95	4KV/6KV	153*63*33mm
	DL-100H-CR-MAK	100W	200-277V	32-58V	42-58V	1.3-2.5A	90%	0.95	4KV/6KV	153*63*33mm
150W	DL-150H-R-MAK	150W	200-277V	32-58V	32-38V	1.8-3.6A	90%	0.95	6KV/15KV	200*63*33mm
	DL-150H-CR-MAK	150W	200-277V	32-58V	42-58V	1.8-3.6A	90%	0.95	6KV/15KV	200*63*33mm
200W	DL-200H-R-MAK	200W	200-277V	32-58V	42-58V	2.6-4.8A	91%	0.95	6KV/15KV	255*63*33mm
	DL-200H-CR-MAK	200W	200-277V	32-58V	42-58V	2.6-4.8A	91%	0.95	6KV/15KV	255*63*33mm
240W	DL-240H-R-MAK	240W	200-277V	32-58V	42-58V	2.6-4.8A	91%	0.95	6KV/15KV	255*63*33mm
	DL-240H-CR-MAK	240W	200-277V	32-58V	42-58V	2.6-4.8A	91%	0.95	6KV/15KV	255*63*33mm

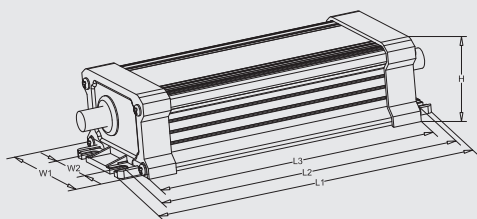

	Product Size					
	L1	L2	L3	W1	W2	H
30W	110mm	100mm	90mm	63mm	32mm	33mm
50W	110mm	100mm	90mm	63mm	32mm	33mm
75W	153mm	143mm	133mm	63mm	32mm	32mm
100W	153mm	143mm	133mm	63mm	32mm	32mm
150W	200mm	190mm	180mm	63mm	32mm	32mm
200W	255mm	245mm	235mm	63mm	32mm	32mm
240W	255mm	245mm	235mm	63mm	32mm	32mm

R type: RS485 communication

CR type: RS485 + double color temperature

Input Cable
Ø7.2 H05RN-F 1.0mm²x400mm

Output Cable
7.2 H05RN-F 1.0mm²x250mm

Dimming Cable
UL 21996 22AWGx270mm

PXG

100-277V DALI Dimming LED driver Series



PRODUCT FEATURES

1. Rate input voltage : 100-277Vac
2. 180-260V high output voltage, constant and adjustable power with in the range of 200-260V output voltage.
3. Efficiency up to 96%/High PF \geq 0.97/THD \leq 7%@230VAC Low THD interference.
4. Surge protection:6/10KV.
5. Protection level: IP42
6. SCP/OTP/OVP protection.
7. Life time>70,000 hrs.And 5 years warranty.

	Model	Rated power	Input Voltage	Output Voltage	Constant power voltage	Output Current	Efficiency	Power Factor (230V)	Lightning protection rating	Product Size
100W	DL-100Z-260DX-PXG	100W	100-277V	180-260V	200-260V	0.23-0.5A	94%	0.97	6/10KV	140*43.5*31.5mm
120W	DL-120Z-260DX-PXG	120W	100-277V	180-260V	200-260V	0.25-0.6A	94%	0.97	6/10KV	200*43.5*31.5mm
150W	DL-150Z-260DX-PXG	150W	100-277V	180-260V	200-260V	0.4-0.75A	95%	0.97	6/10KV	200*43.5*31.5mm
200W	DL-200Z-260DX-PXG	200W	100-277V	180-260V	200-260V	0.55-1.05A	95%	0.97	6/10KV	235*43.5*31.5mm
240W	DL-240Z-260DX-PXG	240W	100-277V	180-260V	200-260V	0.75-1.25A	95%	0.97	6/10KV	235*43.5*31.5mm
320W	DL-320Z-260DX-PXG	320W	100-277V	180-260V	200-260V	0.92-1.6A	96%	0.97	6/10KV	260*43.5*31.5mm

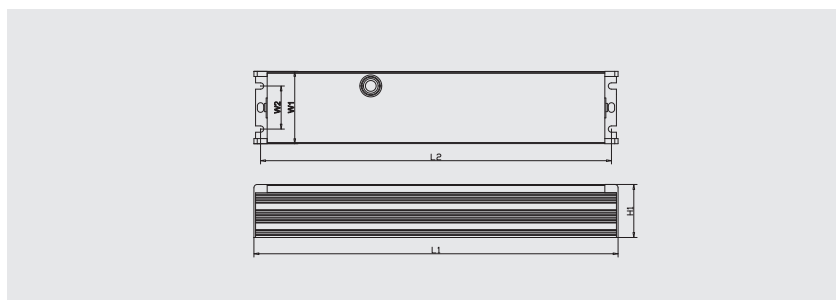

	Product Size					
	L1	L2	L3	W1	W2	H
60W	126mm	118mm	110mm	43.5mm	32mm	31.5mm
100W	140mm	132mm	123mm	43.5mm	32mm	31.5mm
120W	200mm	192mm	183mm	43.5mm	32mm	31.5mm
150W	200mm	192mm	183mm	43.5mm	32mm	31.5mm
200W	235mm	227mm	218mm	43.5mm	32mm	31.5mm
240W	235mm	227mm	218mm	43.5mm	32mm	31.5mm
320W	260mm	252mm	243mm	43.5mm	32mm	31.5mm

Type DX :DALI2.0+auxiliary source

Input Cable
UL1015 18AWG 2.8 x200mm

Output Cable
UL1015 18AWG 2.8 x200mm

Dimming Cable
UL1015 22AWG x220mm

Protection Level **IP42**

CE / SAA / UL / FC / CLASS P

PXL

100-277V IP65 DALI Dimming LED driver Series



PRODUCT FEATURES

1. Rated input voltage: 100-277Vac
2. 180-260V high output voltage, constant and adjustable power within the range of 200-260V output voltage .
3. Efficiency up to 96%/High PF \geq 0.97/THD \leq 7%.
4. Surge protection:4/4KV.
5. Protection level: IP65.
6. SCP/OTP/OVP protection.
7. Life time>70,000 hrs.And 5 years warranty.

	Model	Rated power	Input Voltage	Output Voltage	Constant powervoltage	Output Current	Efficiency	Power Factor (230V)	Lightning protection rating	Product Size
120W	DL-120Z-260DX-PXL	60~120W	100-277V	180-260V	200-260V	0.25-0.6A	94.5%	0.97	4/4KV	127*58mm
150W	DL-150Z-260DX-PXL	100~150W	100-277V	180-260V	200-260V	0.35-0.75A	94.5%	0.97	4/4KV	127*58mm
200W	DL-200Z-260DX-PXL	150~200W	100-277V	180-260V	200-260V	0.55-1.05A	96%	0.97	4/4KV	127*58mm
240W	DL-240Z-260DX-PXL	200~240W	100-277V	180-260V	200-260V	0.75-.1.25A	96%	0.97	4/4KV	127*58mm

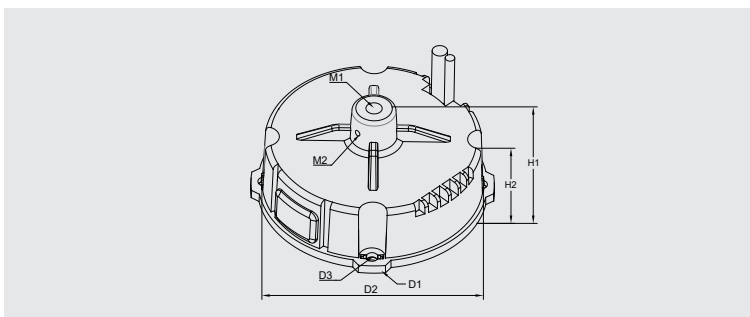

	Product Size						
	D1	D2	D3	H1	H2	M1	M2
120W	127mm	116mm	6.5mm	58mm	37mm	M10*P1.5*H18	M4
150W	127mm	116mm	6.5mm	58mm	37mm	M10*P1.5*H18	M4
200W	127mm	116mm	6.5mm	58mm	37mm	M10*P1.5*H18	M4
240W	127mm	116mm	6.5mm	58mm	37mm	M10*P1.5*H18	M4

Type DX : DALI dimming + auxiliary source

Input Cable
Ø7.5 SJTW 18AWGx300mm

Output Cable
Ø7.0 SJTW 18AWGx250mm

Dimming Cable
UL21996 22AWGx270mm

Protection Level **IP65**



CLASS P



SAA

MCK

120-277V Non-isolated Linear Industrial Lighting LED Driver Series



PRODUCT FEATURES

CE / SAA /  / FC / CLASS P

1. Rated input voltage:120-277Vac
2. Output voltage:180-260Vdc,constant power voltage range@200-260V.
3. Efficiency up to 95%/High PF \geq 0.95/THD \leq 10%@230VAC Low THD interference.
4. Surge protection:6KV/10KV.
5. Protection level: IP42.
6. SCP/OTP/OVP protection.
7. Life time>50,000 hrs.And 5 years warranty.

Type A adjustable potentiometer version

Type S three in one dimming version

Type X programming auxiliary output version

MCK series

	Model	Rated power	Input Voltage	Output Voltage	Constant.povoltage	Output Current	Efficiency	Power Factor (230V)	Lightning protection rating	Product Size
120W	DL-120W-V260A/S/X-MCK	120W	120-277V	180~260V	200-260V	0.25-0.6A	95%	0.95	6KV/10KV	150*57*32mm
150W	DL-150W-V260A/S/X-MCK	150W	120-277V	180~260V	200-260V	0.4-0.75A	95%	0.95	6KV/10KV	150*57*32mm
200W	DL-200W-V260A/S/X-MCK	200W	120-277V	180~260V	200-260V	0.55-1.05A	95%	0.95	6KV/10KV	173*57*37mm
240W	DL-240W-V260A/S/X-MCK	240W	120-277V	180~260V	200-260V	0.75-1.25A	95%	0.95	6KV/10KV	173*57*37mm

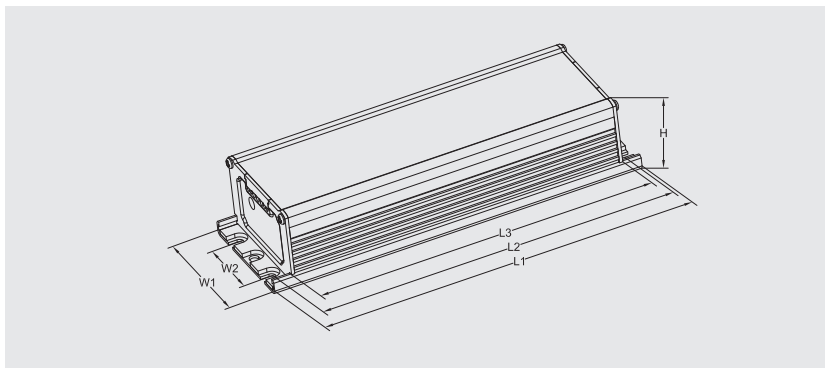

MCK	Product Size					
	L1	L2	L3	W1	W2	H
120W	150mm	142mm	133mm	57mm	32mm	32mm
150W	150mm	142mm	133mm	57mm	32mm	32mm
200W	173mm	165mm	156mm	57mm	32mm	37mm
240W	173mm	165mm	156mm	57mm	32mm	37mm

Input Cable
UL1015 18AWG \varnothing 2.8 x200mm

Output Cable
UL1015 18AWG \varnothing 2.8 x200mm

Dimming Cable
UL1015 22AWG x220mm

PXG

Global Non-Isolated Linear Industrial Lighting LED Driver Series



PRODUCT FEATURES

1. Rate input voltage : W version:120-277Vac; V version: 220-480Vac ; M version: 120-347Vac.
2. 180-260V high output voltage, constant power with the range of 200-260V output voltage.
3. Efficiency up to 95%/High PF \geq 0.95/THD \leq 10%@230VAC Low THD interference.
4. Surge protection:6/10KV.
5. Protection level: IP42
6. SCP/OTP/OVP protection.
7. Life time>70,000 hrs.And 5 years warranty.

	Model	Rated power	Input Voltage	Output Voltage	Constant power voltage	Output Current	Efficiency	Power Factor (230V)	Lightning protection rating	Product Size
40W	DL-40Z-260A/S/X-PXG	40W	100-277V	180-260V	200-260V	0.08-0.2A	93%	0.97	6/10KV	124*43.5*31.5mm
60W	DL-60Z-260A/S/X-PXG	60W	100-277V	180-260V	200-260V	0.15-0.3A	93.5%	0.97	6/10KV	124*43.5*31.5mm
80W	DL-80Z-260A/S/X-PXG	80W	100-277V	180-260V	200-260V	0.23-0.4A	93.5%	0.97	6/10KV	140*43.5*31.5mm
100W	DL-100Z-260A/S/X-PXG	100W	100-277V	180-260V	200-260V	0.23-0.5A	94%	0.97	6/10KV	140*43.5*31.5mm
120W	DL-120Z-260A/S/X-PXG	120W	100-277V	180-260V	200-260V	0.25-0.6A	94.5%	0.97	6/10KV	200*43.5*31.5mm
150W	DL-150Z-260A/S/X-PXG	150W	100-277V	180-260V	200-260V	0.4-0.75A	94.5%	0.97	6/10KV	200*43.5*31.5mm
200W	DL-200Z-260A/S/X-PXG	200W	100-277V	180-260V	200-260V	0.55-1.05A	94.5%	0.97	6/10KV	235*43.5*31.5mm
240W	DL-240Z-260A/S/X-PXG	240W	100-277V	180-260V	200-260V	0.75-1.25A	95%	0.97	6/10KV	235*43.5*31.5mm
320W	DL-320Z-260A/S/X-PXG	320W	100-277V	180-260V	200-260V	0.92-1.6A	96%	0.97	6/10KV	170*43.5*31.5mm

120-347V North American Industrial LED Driver Series

100W	DL-100M-260A/S/X-PXG	100W	120-347V	180-260V	200-260V	0.23-0.5A	94%	0.97	6/10KV	140*43.5*31.5mm
120W	DL-120M-260A/S/X-PXG	120W	120-347V	180-260V	200-260V	0.25-0.6A	94.5%	0.97	6/10KV	200*43.5*31.5mm
150W	DL-150M-260A/S/X-PXG	150W	120-347V	180-260V	200-260V	0.4-0.75A	95%	0.97	6/10KV	200*43.5*31.5mm
200W	DL-200M-260A/S/X-PXG	200W	120-347V	180-260V	200-260V	0.55-1.05A	95%	0.97	6/10KV	235*43.5*31.5mm
240W	DL-240M-260A/S/X-PXG	240W	120-347V	180-260V	200-260V	0.75-1.25A	95%	0.97	6/10KV	235*43.5*31.5mm
320W	DL-320M-260A/S/X-PXG	320W	120-347V	180-260V	200-260V	0.92-1.6A	96%	0.97	6/10KV	260*43.5*31.5mm

220-480V Super High Voltage Input LED Driver Series

100W	DL-100V-260A/S/X-PXG	100W	200-480V	180-260V	200-260V	0.23-0.5A	94%	0.97	6/10KV	140*43.5*31.5mm
120W	DL-120V-260A/S/X-PXG	120W	200-480V	180-260V	200-260V	0.25-0.6A	94.5%	0.97	6/10KV	220*43.5*31.5mm
150W	DL-150V-260A/S/X-PXG	150W	200-480V	180-260V	200-260V	0.4-0.75A	94.5%	0.97	6/10KV	220*43.5*31.5mm
200W	DL-200V-260A/S/X-PXG	200W	200-480V	180-260V	200-260V	0.55-1.05A	95.5%	0.97	6/10KV	244*43.5*31.5mm
240W	DL-240V-260A/S/X-PXG	240W	200-480V	180-260V	200-260V	0.75-1.25A	95.5%	0.97	6/10KV	244*43.5*31.5mm
320W	DL-320V-260A/S/X-PXG	320W	200-480V	180-260V	200-260V	0.92-1.6A	95.5%	0.97	6/10KV	270*43.5*31.5mm

Double color temperature DIP

100W	DL-100Z-260CX-PXG	100W	100-277V	180-260V	200-260V	0.23-0.5A	94%	0.97	6/10KV	140*43.5*31.5mm
120W	DL-120Z-260CX-PXG	120W	100-277V	180-260V	200-260V	0.25-0.6A	94.5%	0.97	6/10KV	200*43.5*31.5mm
150W	DL-150Z-260CX-PXG	150W	100-277V	180-260V	200-260V	0.4-0.75A	95%	0.97	6/10KV	200*43.5*31.5mm
200W	DL-200Z-260CX-PXG	200W	100-277V	180-260V	200-260V	0.55-1.05A	95%	0.97	6/10KV	235*43.5*31.5mm
240W	DL-240Z-260CX-PXG	240W	100-277V	180-260V	200-260V	0.75-1.25A	95%	0.97	6/10KV	235*43.5*31.5mm
320W	DL-320Z-260CX-PXG	320W	100-277V	180-260V	200-260V	0.92-1.6AA	95.5%	0.97	6/10KV	260*43.5*31.5mm

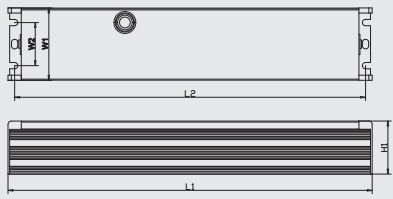

PXG	Product Size					
	L1	L2	L3	W1	W2	H
60W	130mm	122mm	113mm	43.5mm	32mm	31.5mm
100W	150mm	142mm	133mm	43.5mm	32mm	31.5mm
120W	200mm	192mm	183mm	43.5mm	32mm	31.5mm
150W	200mm	192mm	183mm	43.5mm	32mm	31.5mm
200W	235mm	227mm	218mm	43.5mm	32mm	31.5mm
240W	235mm	227mm	218mm	43.5mm	32mm	31.5mm
320W	270mm	262mm	253mm	43.5mm	32mm	31.5mm

Type C+X: (two-color temperature dimming and tone adjustment power)

Type A: adjustable potentiometer version

Type S: three in one dimming version

Type X: programming auxiliary output

Input Cable
UL1015 18AWG 2.8 x200mm

Output Cable
UL1015 18AWG 2.8 x200mm

Dimming Cable
UL1015 22AWG x220mm

Protection Level **IP42**

CE / SAA / UL / FC / cUL us E479166 / CLASS P

SPF

120-277V Global Non-Isolated Industrial Lighting LED Driver Series



PRODUCT FEATURES

CE / CB / CCC / SAA / FC / CLASS P / UL

1. Rated input voltage: 120-277Vac
2. Output voltage:180-260Vdc,constant power voltage range@200-260V.
3. Efficiency up to 95%/High PF \geq 0.95/THD \leq 10%@230VAC Low THD interference.
4. Surge protection:4/4KV.
5. Protection level: IP65.
6. SCP/OTP/OVP/UVP protection .
7. Life time>50,000 hrs.And 5 years warranty.

Type A: adjustment potentiometer version

S-type three in one dimming version

Type X: programming auxiliary output version

Non-isolated Universal UFO LED Driver

	Model	Rated power	Input Voltage	Output Voltage	Constant powervoltage	Output Current	Efficiency	Power Factor (230V)	Lightning protection rating	Product Size
120W	DL-120W-V260A/S/X-SPF	60~120W	120-277V	180-260V	200-260V	0.25-0.6A	95%	0.95	4KV/4KV	D*H 110*58mm
150W	DL-150W-V260A/S/X-SPF	100~150W	120-277V	180-260V	200-260V	0.35-0.75A	95%	0.95	4KV/4KV	D*H 110*58mm
200W	DL-200W-V260A/S/X-SPF	150~200W	120-277V	180-260V	200-260V	0.55-1.05A	95%	0.95	4KV/4KV	D*H 127*60mm
240W	DL-240W-V260A/S/X-SPF	200~240W	120-277V	180-260V	200-260V	0.75-1.25A	95%	0.95	4KV/4KV	D*H 127*60mm

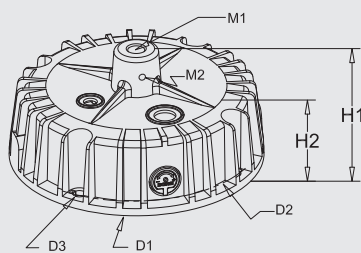

Product Size

	D1	D2	D3	H1	H2	M1	M2
120W	110mm	98mm	6.5mm	58mm	37mm	M10*P1.5*H18	M4
150W	110mm	98mm	6.5mm	58mm	37mm	M10*P1.5*H18	M4
200W	127mm	113mm	6.5mm	60mm	39mm	M10*P1.5*H18	M4
240W	127mm	113mm	6.5mm	60mm	39mm	M10*P1.5*H18	M4

Input Cable
Ø7.5 SJTW 18AWGx300mm

Output Cable
Ø7.0 SJTW 18AWGx250mm

Dimming Cable
UL21996 22AWGx270mm

PXL

Universal Non-isolated double-color temperature dimming UFO LED Driver series



PRODUCT FEATURES

UL / FC / CLASS P / CB / CE / CCC / SAA

1. Rated input voltage:200-277V.
2. 180-260V high output voltage, constant and adjustable power within the range of 200-260V output voltage .
3. Efficiency up to 95%/High PF \geq 0.95/THD \leq 10%.
4. Surge protection:4/4KV.
5. Protection level: IP65.
6. SCP/OTP/OVP protection.
7. Life time>70,000 hrs.And 5 years warranty.

Type A: adjustment potentiometer version

Type X: programming auxiliary output version

Type S: three in one dimming version

Type C+X: (two-color temperature dimming and tone adjustment power

	Model	Rated power	Input Voltage	Output Voltage	Constant power voltage	Output Current	Efficiency	Power Factor (230V)	Lightning protection rating	Product Size
120W	DL-120Z-260CX-PXL	60~120W	120-277V	180-260V	200-260V	0.25-0.6A	95%	0.97	4/4KV	127*58mm
150W	DL-150Z-260CX-PXL	100~150W	120-277V	180-260V	200-260V	0.35-0.75A	95%	0.97	4/4KV	127*58mm
200W	DL-200Z-260CX-PXL	150~200W	120-277V	180-260V	200-260V	0.55-1.05A	95%	0.97	4/4KV	127*58mm
240W	DL-240Z-260CX-PXL	200~240W	120-277V	180-260V	200-260V	0.75-1.25A	95%	0.97	4/4KV	127*58mm

120-347V North American Industrial Voltage UFO LED Driver

120W	DL-120M-260A/S/X-PXL	60~120W	120-347V	180-260V	200-260V	0.25-0.6A	95%	0.97	4/4KV	127*58mm
150W	DL-150M-260A/S/X-PXL	100~150W	120-347V	180-260V	200-260V	0.35-0.75A	95%	0.97	4/4KV	127*58mm
200W	DL-200M-260A/S/X-PXL	150~200W	120-347V	180-260V	200-260V	0.55-1.05A	95%	0.97	4/4KV	127*58mm
240W	DL-240M-260A/S/X-PXL	200~240W	120-347V	180-260V	200-260V	0.75-1.25A	95%	0.97	4/4KV	127*58mm

220-480V Super High Voltage Input UFO LED Driver

120W	DL-120V-260A/S/X-PXL	60~120W	220-480V	180-260V	200-260V	0.25-0.6A	95%	0.97	4/4KV	127*58mm
150W	DL-150V-260A/S/X-PXL	100~150W	220-480V	180-260V	200-260V	0.35-0.75A	95%	0.97	4/4KV	127*58mm
200W	DL-200V-260A/S/X-PXL	150~200W	220-480V	180-260V	200-260V	0.55-1.05A	95%	0.97	4/4KV	127*58mm
240W	DL-240V-260A/S/X-PXL	200~240W	220-480V	180-260V	200-260V	0.75-1.25A	95%	0.97	4/4KV	127*58mm

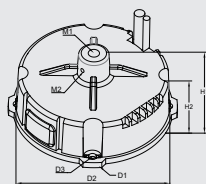

Product Size

	D1	D2	D3	H1	H2	M1	M2
120W	127mm	116mm	6.5mm	58mm	37mm	M10*P1.5*H18	M4
150W	127mm	116mm	6.5mm	58mm	37mm	M10*P1.5*H18	M4
200W	127mm	116mm	6.5mm	58mm	37mm	M10*P1.5*H18	M4
240W	127mm	116mm	6.5mm	58mm	37mm	M10*P1.5*H18	M4

Input Cable
Ø7.5 SJTW 18AWGx300mm

Output Cable
Ø7.0 SJTW 18AWGx250mm

Dimming Cable
UL21996 22AWGx270mm

SBS

Industrial explosion-proof LED driver



CE / CCC / 符合EX II 2G EX mb IIC GB

PRODUCT FEATURES

1. Rated input voltage:100-277Vac.
2. Output voltage:20-38V/32-58V,constant power voltage:32-38V/42-58V.
3. Meet explosion-proof industry 5-6 series@6V or 10-12 series@3V LED chips usage.
4. High efficiency up to 90%/Power factor 0.95/THD<10%.
5. Surge protection:4KV/6KV.
6. Protection level: IP65.
7. SCP/OTP/OVP/UVP protection function.
8. Life time>50,000 hrs.And 5 years warranty.

Type A: adjustment potentiometer version

	Model	Rated power	Input Voltage	Output Voltage	Constant powervoltage	Output Current	Efficiency	Power Factor (230V)	Lightning protection rating	Product Size
40W	DL-40Z-V38A-SBS	40W	100-277V	20-38V	32~38	0.7~1.6A	89%	0.95	4KV/6KV	D*H 75*33mm
	DL-40Z-V58A-SBS	40W	100-277V	32-58V	42~58	0.35~0.95A	89%	0.95	4KV/6KV	D*H 75*33mm
60W	DL-60Z-V38A-SBS	60W	100-277V	20-38V	32~38	1.3~2.5A	89.5%	0.95	4KV/6KV	D*H 90*33mm
	DL-60Z-V58A-SBS	60W	100-277V	32-58V	42~58	0.7~1.45A	89.5%	0.95	4KV/6KV	D*H 90*33mm
80W	DL-80Z-V38A-SBS	80W	100-277V	20-38V	32~38	1.9~3.5A	90%	0.95	4KV/6KV	D*H 110*38mm
	DL-80Z-V58A-SBS	80W	100-277V	32-58V	42~58	1.05~1.9A	90%	0.95	4KV/6KV	D*H 110*38mm
100W	DL-100Z-V38A-SBS	100W	100-277V	20-38V	32~38	2.1~3.15A	90%	0.95	4KV/6KV	D*H 110*38mm
	DL-100Z-V58A-SBS	100W	100-277V	32-58V	42~58	1.4~2.4A	90%	0.95	4KV/6KV	D*H 110*38mm

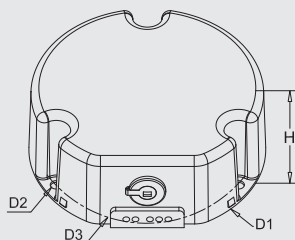

Product Size

	D1	D2	D3	H
40W	75mm	4.5mm	65mm	33mm
60W	90mm	4.5mm	80mm	33mm
80W	110mm	4.5mm	100mm	38mm
100W	110mm	4.5mm	100mm	38mm

Input Cable
UL1015 18#AWG Ø2.8x200mm

Output Cable
UL1015 18#AWG Ø2.8x200mm

RXG

200-277Vac outdoor waterproof constant voltage LED driver series



PRODUCT FEATURES

1. Rated input voltage:200-277V.
2. 12V/24V/36V/48VConstant voltage output .
3. Efficiency up to 94.5%/High PF>0.98/THD<10%@230Vac.
4. Surge protection:4/6KV.
5. Protection level: IP67.
6. SCP/OTP/OVP/UVI protection.
7. Life time>50,000 hrs.And 5 years warranty.

	产品型号 Model	额定功率 Rated power	额定输入电压 Input Voltage	输出电压 Output Voltage	防水等级 Protection level	输出电流 Output Current	效率 Efficiency	PF值 (230V)	防雷等级 Lightning protection rating	产品尺寸 Product Size
40W	DL-40H-V12-RXG	0-40W	200-277V	12V	IP67	0-3.33A	87%	0.95	4KV/6KV	90*63*32mm
	DL-40H-V24-RXG	0-40W	200-277V	24V	IP67	0-1.67A	87%	0.95	4KV/6KV	90*63*32mm
	DL-40H-V36-RXG	0-40W	200-277V	36V	IP67	0-1.11A	87%	0.95	4KV/6KV	90*63*32mm
	DL-40H-V48-RXG	0-40W	200-277V	48V	IP67	0-0.83A	87%	0.95	4KV/6KV	90*63*32mm
60W	DL-60H-V12-RXG	0-60W	200-277V	12V	IP67	0-5.0A	88%	0.95	4KV/6KV	105*63*32mm
	DL-60H-V24-RXG	0-60W	200-277V	24V	IP67	0-2.5A	88%	0.95	4KV/6KV	105*63*32mm
	DL-60H-V36-RXG	0-60W	200-277V	36V	IP67	0-1.67A	88%	0.95	4KV/6KV	105*63*32mm
	DL-60H-V48-RXG	0-60W	200-277V	48V	IP67	0-1.25A	88%	0.95	4KV/6KV	105*63*32mm
75W	DL-75H-V12-RXG	0-75W	200-277V	12V	IP67	0-6.25A	88%	0.96	4KV/6KV	138*63*32mm
	DL-75H-V24-RXG	0-75W	200-277V	24V	IP67	0-3.15A	89%	0.96	4KV/6KV	138*63*32mm
	DL-75H-V36-RXG	0-75W	200-277V	36V	IP67	0-2.1A	89%	0.96	4KV/6KV	138*63*32mm
	DL-75H-V48-RXG	0-75W	200-277V	48V	IP67	0-1.57	89%	0.96	4KV/6KV	138*63*32mm
100W	DL-100H-V12-RXG	0-100W	200-277V	12V	IP67	0-8.35A	88%	0.96	4KV/6KV	153*63*32mm
	DL-100H-V24-RXG	0-100W	200-277V	24V	IP67	0-4.2A	89%	0.96	4KV/6KV	153*63*32mm
	DL-100H-V36-RXG	0-100W	200-277V	36V	IP67	0-2.78A	89%	0.96	4KV/6KV	153*63*32mm
	DL-100H-V48-RXG	0-100W	200-277V	48V	IP67	0-2.1A	89%	0.96	4KV/6KV	153*63*32mm
150W	DL-150H-V12-RXG	0-150W	200-277V	12V	IP67	0-12.5A	89%	0.96	4KV/6KV	186*63*32mm
	DL-150H-V24-RXG	0-150W	200-277V	24V	IP67	0-6.25A	90%	0.96	4KV/6KV	186*63*32mm
	DL-150H-V36-RXG	0-150W	200-277V	36V	IP67	0-4.17A	90%	0.96	4KV/6KV	186*63*32mm
	DL-150H-V48-RXG	0-150W	200-277V	48V	IP67	0-3.13A	90%	0.96	4KV/6KV	186*63*32mm
200W	DL-200H-V12-RXG	0-200W	200-277V	12V	IP67	0-16.7A	92%	0.97	4KV/6KV	199*63*37mm
	DL-200H-V24-RXG	0-200W	200-277V	24V	IP67	0-8.33A	93%	0.97	4KV/6KV	199*63*37mm
	DL-200H-V36-RXG	0-200W	200-277V	36V	IP67	0-5.56A	93%	0.97	4KV/6KV	199*63*37mm
	DL-200H-V48-RXG	0-200W	200-277V	48V	IP67	0-4.17A	93%	0.97	4KV/6KV	199*63*37mm
250W	DL-250H-V12-RXG	0-250W	200-277V	12V	IP67	0-20.83A	92%	0.97	4KV/6KV	199*63*37mm
	DL-250H-V24-RXG	0-250W	200-277V	24V	IP67	0-10.42A	93%	0.97	4KV/6KV	199*63*37mm
	DL-250H-V36-RXG	0-250W	200-277V	36V	IP67	0-6.95A	93%	0.97	4KV/6KV	199*63*37mm
	DL-250H-V48-RXG	0-250W	200-277V	48V	IP67	0-5.21A	93%	0.97	4KV/6KV	199*63*37mm

320W	DL-320H-V12-RXG	0-320W	200-277V	12V	IP67	0-26.67A	92%	0.97	4KV/6KV	230*68*37mm
	DL-320H-V24-RXG	0-320W	200-277V	24V	IP67	0-13.33A	94%	0.97	4KV/6KV	230*68*37mm
	DL-320H-V36-RXG	0-320W	200-277V	36V	IP67	0-8.9A	94%	0.97	4KV/6KV	230*68*37mm
	DL-320H-V48-RXG	0-320W	200-277V	48V	IP67	0-6.67A	94%	0.97	4KV/6KV	230*68*37mm
400W	DL-400H-V24-RXG	0-400W	200-277V	24V	IP67	0-16.67A	94%	0.97	4KV/6KV	244*83*40mm
	DL-400H-V36-RXG	0-400W	200-277V	36V	IP67	0-11.15A	94%	0.97	4KV/6KV	244*83*40mm
	DL-400H-V48-RXG	0-400W	200-277V	48V	IP67	0-8.35A	94%	0.97	4KV/6KV	244*83*40mm

全压防水恒压系列

40W	DL-40W-V12-RXG	0-40W	100-277V	12V	IP67	0-6.25A	87%	0.95	6KV/10KV	100*63*32mm
	DL-40W-V24-RXG	0-40W	100-277V	24V	IP67	0-3.15A	87%	0.95	6KV/10KV	100*63*32mm
	DL-40W-V36-RXG	0-40W	100-277V	36V	IP67	0-2.1A	87%	0.95	6KV/10KV	100*63*32mm
	DL-40W-V48-RXG	0-40W	100-277V	48V	IP67	0-1.57	87%	0.95	6KV/10KV	100*63*32mm
60W	DL-60W-V12-RXG	0-60W	100-277V	12V	IP67	0-8.35A	88%	0.95	6KV/10KV	110*63*32mm
	DL-60W-V24-RXG	0-60W	100-277V	24V	IP67	0-4.2A	88%	0.95	6KV/10KV	110*63*32mm
	DL-60W-V36-RXG	0-60W	100-277V	36V	IP67	0-2.78A	88%	0.95	6KV/10KV	110*63*32mm
	DL-60W-V48-RXG	0-60W	100-277V	48V	IP67	0-2.1A	88%	0.95	6KV/10KV	110*63*32mm
75W	DL-75W-V12-RXG	0-75W	100-277V	12V	IP67	0-12.5A	88%	0.96	6KV/10KV	143*63*32mm
	DL-75W-V24-RXG	0-75W	100-277V	24V	IP67	0-6.25A	89%	0.96	6KV/10KV	143*63*32mm
	DL-75W-V36-RXG	0-75W	100-277V	36V	IP67	0-4.17A	89%	0.96	6KV/10KV	143*63*32mm
	DL-75W-V48-RXG	0-75W	100-277V	48V	IP67	0-3.13A	89%	0.96	6KV/10KV	143*63*32mm
100W	DL-100W-V12-RXG	0-100W	100-277V	12V	IP67	0-16.7A	88%	0.96	6KV/10KV	158*63*37mm
	DL-100W-V24-RXG	0-100W	100-277V	24V	IP67	0-8.33A	89%	0.96	6KV/10KV	158*63*37mm
	DL-100W-V36-RXG	0-100W	100-277V	36V	IP67	0-5.56A	89%	0.96	6KV/10KV	158*63*37mm
	DL-100W-V48-RXG	0-100W	100-277V	48V	IP67	0-4.17A	89%	0.96	6KV/10KV	158*63*37mm
150W	DL-150W-V12-RXG	0-150W	100-277V	12V	IP67	0-20.83A	89%	0.96	6KV/10KV	191*63*37mm
	DL-150W-V24-RXG	0-150W	100-277V	24V	IP67	0-10.42A	90%	0.96	6KV/10KV	191*63*37mm
	DL-150W-V36-RXG	0-150W	100-277V	36V	IP67	0-6.95A	90%	0.96	6KV/10KV	191*63*37mm
	DL-150W-V48-RXG	0-150W	100-277V	48V	IP67	0-5.21A	90%	0.96	6KV/10KV	191*63*37mm
200W	DL-200W-V12-RXG	0-200W	100-277V	12V	IP67	0-26.67A	92%	0.97	6KV/10KV	209*63*37mm
	DL-200W-V24-RXG	0-200W	100-277V	24V	IP67	0-13.33A	93%	0.97	6KV/10KV	209*63*37mm
	DL-200W-V36-RXG	0-200W	100-277V	36V	IP67	0-8.9A	93%	0.97	6KV/10KV	209*63*37mm
	DL-200W-V48-RXG	0-200W	100-277V	48V	IP67	0-6.67A	93%	0.97	6KV/10KV	209*63*37mm
250W	DL-250W-V12-RXG	0-250W	100-277V	12V	IP67	0-33.33A	92%	0.97	6KV/10KV	227*63*37mm
	DL-250W-V24-RXG	0-250W	100-277V	24V	IP67	0-16.67A	93%	0.97	6KV/10KV	227*63*37mm
	DL-250W-V36-RXG	0-250W	100-277V	36V	IP67	0-11.15A	93%	0.97	6KV/10KV	227*63*37mm
	DL-250W-V48-RXG	0-250W	100-277V	48V	IP67	0-8.35A	93%	0.97	6KV/10KV	227*63*37mm
320W	DL-320W-V12-RXG	0-320W	100-277V	12V	IP67	0-20.83A	92%	0.97	6KV/10KV	240*68*37mm
	DL-320W-V24-RXG	0-320W	100-277V	24V	IP67	0-10.42A	94%	0.97	6KV/10KV	240*68*37mm
	DL-320W-V36-RXG	0-320W	100-277V	36V	IP67	0-6.95A	94%	0.97	6KV/10KV	240*68*37mm
	DL-320W-V48-RXG	0-320W	100-277V	48V	IP67	0-5.21A	94%	0.97	6KV/10KV	240*68*37mm
400W	DL-400W-V12-RXG	0-400W	100-277V	12V	IP67	0-26.67A	94%	0.97	6KV/10KV	254*83*40mm
	DL-400W-V24-RXG	0-400W	100-277V	24V	IP67	0-13.33A	94%	0.97	6KV/10KV	254*83*40mm
	DL-400W-V36-RXG	0-400W	100-277V	36V	IP67	0-8.9A	94%	0.97	6KV/10KV	254*83*40mm
	DL-400W-V48-RXG	0-400W	100-277V	48V	IP67	0-6.67A	94%	0.97	6KV/10KV	254*83*40mm
600W	DL-600W-V12-RXG	0-600W	100-277V	12V	IP67	0-33.33A	94.5%	0.97	6KV/10KV	265*130*45mm
	DL-600W-V24-RXG	0-600W	100-277V	24V	IP67	0-16.67A	94.5%	0.97	6KV/10KV	265*130*45mm
	DL-600W-V36-RXG	0-600W	100-277V	36V	IP67	0-11.15A	94.5%	0.97	6KV/10KV	265*130*45mm
	DL-600W-V48-RXG	0-600W	100-277V	48V	IP67	0-8.35A	94.5%	0.97	6KV/10KV	265*130*45mm

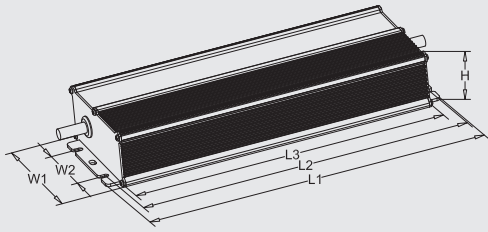

Product Size

	L1	L2	L3	W1	W2	H
75W	138mm	128mm	117mm	63mm	32mm	32mm
100W	153mm	143mm	132mm	63mm	32mm	32mm
150W	186mm	176mm	165mm	63mm	32mm	32mm
200W	199mm	189mm	178mm	63mm	28mm	37mm
250W	199mm	189mm	178mm	63mm	28mm	37mm
320W	230mm	220mm	210mm	68mm	28mm	37mm
400W	244mm	234mm	224mm	83mm	50mm	40mm

Input Cable
 Ø7.2 H05RN-F 1.0mm²x400mm

Output Cable
 Ø6.8 H05RN-F 1.0mm²x250mm
 Ø7.6 H05RN-F 1.5mm²x250mm

Protection Level **IP67**

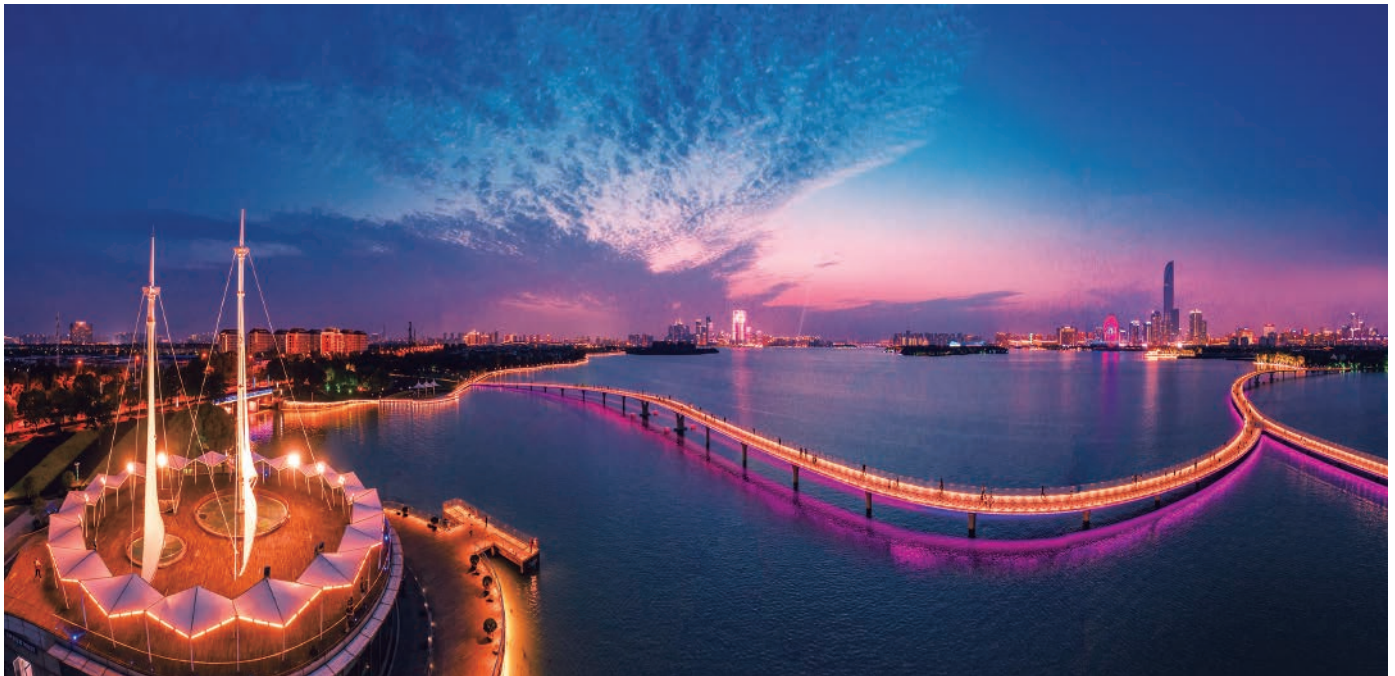

RXL

Constant Voltage Linear Led Driver



PRODUCT FEATURES

1. Input Voltage: 200-240 Vac.
2. 12V/24V/36V/48V Constant voltage output.
3. Efficiency up to 89%/High PF>0.96/THD<10%@230Vac
4. Surge protection: 4/6KV.
5. Protection level: IP67.
6. SCP/OTP/OVP protection.
7. Life time>50,000 hrs.And 5 years warranty.

	Model	Rated power	Input Voltage	Output Voltage	Protection level	Output Current	Efficiency	Lightning protection rating	Product Size
40W	DL-40H-V12-RXL	0-40W	200-240V	12V	IP65	0-3.3A	84%	4KV/6KV	135*40*30mm
	DL-40H-V24-RXL	0-40W	200-240V	24V	IP65	0-1.67A	85%	4KV/6KV	135*40*30mm
	DL-40H-V36-RXL	0-40W	200-240V	36V	IP65	0-1.1A	85%	4KV/6KV	135*40*30mm
	DL-40H-V48-RXL	0-40W	200-240V	48V	IP65	0-0.83A	85%	4KV/6KV	135*40*30mm
60W	DL-60H-V12-RXL	0-60W	200-240V	12V	IP65	0-5A	86%	4KV/6KV	145*40*30mm
	DL-60H-V24-RXL	0-60W	200-240V	24V	IP65	0-2.5A	87%	4KV/6KV	145*40*30mm
	DL-60H-V36-RXL	0-60W	200-240V	36V	IP65	0-1.67A	87%	4KV/6KV	145*40*30mm
	DL-60H-V48-RXL	0-60W	200-240V	48V	IP65	0-1.25A	87%	4KV/6KV	145*40*30mm
75W	DL-75H-V12-RXL	0-75W	200-240V	12V	IP65	0-6.25A	86%	4KV/6KV	160*40*30mm
	DL-75H-V24-RXL	0-75W	200-240V	24V	IP65	0-3.15A	88%	4KV/6KV	160*40*30mm
	DL-75H-V36-RXL	0-75W	200-240V	36V	IP65	0-2.1A	88%	4KV/6KV	160*40*30mm
	DL-75H-V48-RXL	0-75W	200-240V	48V	IP65	0-1.57A	88%	4KV/6KV	160*40*30mm

	Product Size					
	L1	L2	L3	W1	W2	H
40W	135mm	-mm	-mm	40mm	-mm	30mm
60W	145mm	-mm	-mm	40mm	-mm	30mm
75W	160mm	-mm	-mm	40mm	-mm	30mm

Protection Level **IP67**



RXC

Waterproof CQC Certificated Constant Voltage Led Driver



PRODUCT FEATURES

1. Rated input voltage: 200-240V.
2. 12V/24V/36V/48V Constant voltage output .
3. Efficiency up to 91%
4. Surge protection:4/6KV.
5. Protection level: IP67.
6. SCP/OTP/OVP protection.
7. Life time>50,000 hrs.And 5 years warranty.

Input Cable

Ø7.2 H05RN-F 1.0mm²x300mm

Output Cable

Ø6.8 H05RN-F 1.0mm²x250mm
Ø7.6 H05RN-F 1.5mm²x250mm

	Model	Rated power	Input Voltage	Output Voltage	Protection level	Output Current	Efficiency	Lightning protection rating	Product Size
100W	DL-100H-V12-RXC	0-80W	200-240V	12V	IP67	0-6.67A	88%	4KV/6KV	186*63*32mm
	DL-100H-V24-RXC	0-100W	200-240V	24V	IP67	0-4.2A	89%	4KV/6KV	186*63*32mm
	DL-100H-V36-RXC	0-100W	200-240V	36V	IP67	0-2.78A	89%	4KV/6KV	186*63*32mm
	DL-100H-V48-RXC	0-100W	200-240V	48V	IP67	0-2.1A	89%	4KV/6KV	186*63*32mm
150W	DL-150H-V12-RXC	0-120W	200-240V	12V	IP67	0-10A	89%	4KV/6KV	186*63*32mm
	DL-150H-V24-RXC	0-150W	200-240V	24V	IP67	0-6.25A	90%	4KV/6KV	186*63*32mm
	DL-150H-V36-RXC	0-150W	200-240V	36V	IP67	0-4.17A	90%	4KV/6KV	186*63*32mm
	DL-150H-V48-RXC	0-150W	200-240V	48V	IP67	0-3.13A	90%	4KV/6KV	186*63*32mm
200W	DL-200H-V12-RXC	0-160W	200-240V	12V	IP67	0-13.33A	90%	4KV/6KV	199*63*37mm
	DL-200H-V24-RXC	0-200W	200-240V	24V	IP67	0-8.33A	90%	4KV/6KV	199*63*37mm
	DL-200H-V36-RXC	0-200W	200-240V	36V	IP67	0-5.56A	90%	4KV/6KV	199*63*37mm
	DL-200H-V48-RXC	0-200W	200-240V	48V	IP67	0-4.17A	90%	4KV/6KV	199*63*37mm
250W	DL-250H-V12-RXC	0-200W	200-240V	12V	IP67	0-16.67A	90%	4KV/6KV	199*63*37mm
	DL-250H-V24-RXC	0-250W	200-240V	24V	IP67	0-10.42A	90%	4KV/6KV	199*63*37mm
	DL-250H-V36-RXC	0-250W	200-240V	36V	IP67	0-6.95A	90%	4KV/6KV	199*63*37mm
	DL-250H-V48-RXC	0-250W	200-240V	48V	IP67	0-5.21A	90%	4KV/6KV	199*63*37mm
350W	DL-350H-V12-RXC	0-300W	200-240V	12V	IP67	0-25A	91%	4KV/6KV	244*83*40mm
	DL-350H-V24-RXC	0-320W	200-240V	24V	IP67	0-13.33A	91%	4KV/6KV	244*83*40mm
	DL-350H-V36-RXC	0-320W	200-240V	36V	IP67	0-8.9A	91%	4KV/6KV	244*83*40mm
	DL-350H-V48-RXC	0-320W	200-240V	48V	IP67	0-6.67A	91%	4KV/6KV	244*83*40mm
400W	DL-400H-V12-RXC	0-360W	200-240V	12V	IP67	0-30A	91%	4KV/6KV	244*83*40mm
	DL-400H-V24-RXC	0-400W	200-240V	24V	IP67	0-16.67A	91%	4KV/6KV	244*83*40mm
	DL-400H-V36-RXC	0-400W	200-240V	36V	IP67	0-11.15A	91%	4KV/6KV	244*83*40mm
	DL-400H-V48-RXC	0-400W	200-240V	48V	IP67	0-8.35A	91%	4KV/6KV	244*83*40mm

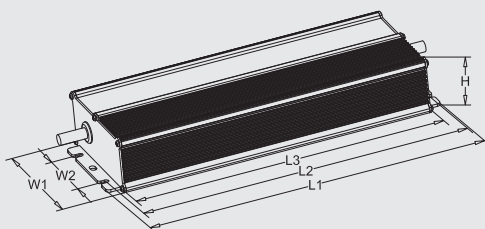

	Product Size					
	L1	L2	L3	W1	W2	H
100W	186mm	176mm	165mm	63mm	32mm	32mm
150W	186mm	176mm	165mm	63mm	32mm	32mm
200W	199mm	189mm	179mm	63mm	28mm	37mm
250W	199mm	189mm	179mm	63mm	28mm	37mm
350W	244mm	234mm	224mm	83mm	28mm	40mm
400W	244mm	234mm	224mm	83mm	50mm	40mm

RAB

AC200-240V rainproof constant voltage LED driver series



PRODUCT FEATURES

1. Rated input Voltage:200-240Vac(Input voltage range:176-264V).
2. 12V 24V、36/49 Constant voltage output.
3. Efficiency up to 91%/THD<10% EN61000-3-2 CLASS A /Type G:PF \geq 0.98.
4. Surge protection:4/4KV.
5. Rainproof structure.
6. SCP/OTP/OVP/UVP protection.
7. Life time>30,000 hrs.And 3 years warranty.

	Model	Rated power	Input Voltage	Output Voltage	Output Current	Efficiency	Lightning protection rating	Product Size
250W	DL-250H-V12-RAB	0-250W	200-240V	12V	0-20.85A	89%	2KV/4KV	200*120*40mm
	DL-250H-V24-RAB	0-250W	200-240V	24V	0-10.42A	90%	2KV/4KV	200*120*40mm
	DL-250H-V36-RAB	0-250W	200-240V	36V	0-6.94A	90%	2KV/4KV	200*120*40mm
	DL-250H-V48-RAB	0-250W	200-240V	48V	0-5.2A	90%	2KV/4KV	200*120*40mm
350W	DL-350H-V12-RAB	0-350W	200-240V	12V	0-29.2A	90%	2KV/4KV	220*130*48mm
	DL-350H-V24-RAB	0-350W	200-240V	24V	0-14.6A	91%	2KV/4KV	220*130*48mm
	DL-350H-V36-RAB	0-350W	200-240V	36V	0-9.72A	91%	2KV/4KV	220*130*48mm
	DL-350H-V48-RAB	0-350W	200-240V	48V	0-8.72A	91%	2KV/4KV	220*130*48mm

Product Size

	L1	L2	L3	W1	W2	H
250W	200mm	-mm	-mm	120mm	-mm	40mm
350W	220mm	-mm	-mm	130mm	-mm	48mm



RAC

AC200-240V rainproof PFC constant voltage LED driver series



PRODUCT FEATURES

1. Rated input Voltage:200-240Vac(Input voltage range:176-264V).
2. 12V 24V Constant voltage output.
3. Efficiency up to 91%/PF \geq 0.98/THD<10% EN61000-3-2 CLASS A .
4. Surge protection:4/6KV.
5. Rainproof structure.
6. SCP/OTP/OVP/UVI protection.
7. Life time>30,000 hrs.And 3 years warranty.

	Model	Rated power	Input Voltage	Output Voltage	Output Current	Efficiency	PF Rate	Lightning protection rating	Product Size
250W	DL-250H-V12-RAC	0-250W	200-240V	12V	0-20.85A	89%	0.98	2KV/4KV	200*120*40mm
	DL-250H-V24-RAC	0-250W	200-240V	24V	0-10.42A	90%	0.98	2KV/4KV	200*120*40mm
	DL-250H-V36-RAC	0-250W	200-240V	36V	0-6.94A	90%	0.98	2KV/4KV	200*120*40mm
	DL-250H-V48-RAC	0-250W	200-240V	48V	0-5.2A	90%	0.98	2KV/4KV	200*120*40mm
400W	DL-400H-V12-RAC	0-400W	200-240V	12V	0-33.34A	90%	0.98	2KV/4KV	220*130*48mm
	DL-400H-V24-RAC	0-400W	200-240V	24V	0-16.67A	91%	0.98	2KV/4KV	220*130*48mm
	DL-400H-V36-RAC	0-400W	200-240V	36V	0-11.11A	91%	0.98	2KV/4KV	220*130*48mm
	DL-400H-V48-RAC	0-400W	200-240V	48V	0-8.33A	91%	0.98	2KV/4KV	220*130*48mm

Product Size						
	L1	L2	L3	W1	W2	
250W	200mm	-mm	-mm	120mm	-mm	40mm
400W	220mm	-mm	-mm	130mm	-mm	48mm



RAP

AC100-277V Waterproof CLASS II Constant Voltage LED Driver



PRODUCT FEATURES



1. Input Voltage:100-277Vac.
2. 12V/24V/36V/48VConstant voltage output.
3. Efficiency up to 90%/THD<10% EN61000-3-2 CLASS A
4. Surge protection:(L-N)4KV.
5. Protection level: IP67.
6. SCP/OTP/OVP/UVP protection.
7. Life time>30,000 hrs.And 5 years warranty.

	Model	Rated power	Input Voltage	Output Voltage	Protection Grade	Output Current	efficiency	Lightning protection rating	Product Size
30W	DL-30W-V12-RAP	0-30W	100-277V	12V	IP65	0-2.5A	82%	4KV	118*40*30mm
	DL-30W-V24-RAP	0-30W	100-277V	24V	IP65	0-1.25A	85%	4KV	118*40*30mm
	DL-30W-V36-RAP	0-30W	100-277V	36V	IP65	0-2.5A	82%	4KV	118*40*30mm
	DL-30W-V48-RAP	0-30W	100-277V	48V	IP65	0-1.25A	85%	4KV	118*40*30mm
50W	DL-50W-V12-RAP	0-50W	100-277V	12V	IP65	0-4.17A	85%	4KV	118*35*26mm
	DL-50W-V24-RAP	0-50W	100-277V	24V	IP65	0-2.1A	85.5%	4KV	118*35*26mm
	DL-50W-V36-RAP	0-50W	100-277V	36V	IP65	0-4.17A	85%	4KV	118*35*26mm
	DL-50W-V48-RAP	0-50W	100-277V	48V	IP65	0-2.1A	85.5%	4KV	118*35*26mm
75W	DL-75W-V12-RAP	0-75W	100-277V	12V	IP65	0-6.25A	86%	4KV	162*40*32mm
	DL-75W-V24-RAP	0-75W	100-277V	24V	IP65	0-3.125A	87%	4KV	162*40*32mm
	DL-75W-V36-RAP	0-75W	100-277V	36V	IP65	0-6.25A	86%	4KV	162*40*32mm
	DL-75W-V48-RAP	0-75W	100-277V	48V	IP65	0-3.125A	87%	4KV	162*40*32mm
100W	DL-100W-V12-RAP	0-100W	100-277V	12V	IP65	0-8.34A	86.5%	4KV	171*53*37mm
	DL-100W-V24-RAP	0-100W	100-277V	24V	IP65	0-4.17A	89%	4KV	171*53*37mm
	DL-100W-V36-RAP	0-100W	100-277V	36V	IP65	0-8.34A	86.5%	4KV	171*53*37mm
	DL-100W-V48-RAP	0-100W	100-277V	48V	IP65	0-4.17A	89%	4KV	171*53*37mm
150W	DL-150W-V12-RAP	0-150W	100-277V	12V	IP65	0-12.5A	89%	4KV	191*63*37mm
	DL-150W-V24-RAP	0-150W	100-277V	24V	IP65	0-6.25A	90%	4KV	191*63*37mm
	DL-150W-V36-RAP	0-150W	100-277V	36V	IP65	0-12.5A	89%	4KV	191*63*37mm
	DL-150W-V48-RAP	0-150W	100-277V	48V	IP65	0-6.25A	90%	4KV	191*63*37mm

Product Size

	L1	L2	L3	W1	W2	H
30W	118mm	-mm	-mm	40mm	-mm	30mm
50W	118mm	-mm	-mm	35mm	-mm	26mm
75W	162mm	-mm	-mm	40mm	-mm	32mm
100W	171mm	-mm	-mm	53mm	-mm	37mm
150W	191mm	-mm	-mm	63mm	-mm	37mm

Input Cable
UL1015 18#AWG Ø2.8x200mm

Output Cable
UL1015 18#AWG Ø2.8x200mm

RAS

Waterproof CLASS II Dimming Constant Voltage Led Driver



CE / CB / UL / ENEC / FC

PRODUCT FEATURES

1. Input Voltage:100-240Vac.
2. 12V/24V/36V/48VConstant voltage output.
3. Efficiency up to 90%/High PF>0.97/THD<10%@230Vac
4. Surge protection:(L-N)4KV.
5. Protection level: IP65.
6. SCP/OTP/OVP/UVF protection.
7. Life time>30,000 hrs.And 5 years warranty.

	Model	Rated power	Input Voltage	Output Voltage	Protection Grade	Output Current	efficiency	Lightning protection rating	Product Size
30W	DL-30W-V12-RAS	0-30W	100-240V	12V	IP65	0-2.5A	89%	4KV	118*35*26mm
	DL-30W-V24-RAS	0-30W	100-240V	24V	IP65	0-1.25A	89%	4KV	118*35*26mm
	DL-30W-V36-RAS	0-30W	100-240V	36V	IP65	0-0.83A	89%	4KV	118*35*26mm
	DL-30W-V48-RAS	0-30W	100-240V	48V	IP65	0-0.63A	89%	4KV	118*35*26mm
50W	DL-50W-V12-RAS	0-50W	100-240V	12V	IP65	0-4.2A	89%	4KV	162*40*30mm
	DL-50W-V24-RAS	0-50W	100-240V	24V	IP65	0-2.1A	89%	4KV	162*40*30mm
	DL-50W-V36-RAS	0-50W	100-240V	36V	IP65	0-1.4A	89%	4KV	162*40*30mm
	DL-50W-V48-RAS	0-50W	100-240V	48V	IP65	0-1.05A	89%	4KV	162*40*30mm
75W	DL-75W-V12-RAS	0-75W	100-240V	12V	IP65	0-6.25A	90%	4KV	162*40*30mm
	DL-75W-V24-RAS	0-75W	100-240V	24V	IP65	0-3.13A	90%	4KV	162*40*30mm
	DL-75W-V36-RAS	0-75W	100-240V	36V	IP65	0-2.15A	90%	4KV	162*40*30mm
	DL-75W-V48-RAS	0-75W	100-240V	48V	IP65	0-1.6A	90%	4KV	162*40*30mm
100W	DL-100W-V12-RAS	0-100W	100-240V	12V	IP65	0-8.3A	90%	4KV	171*53*37mm
	DL-100W-V24-RAS	0-100W	100-240V	24V	IP65	0-4.2A	90%	4KV	171*53*37mm
	DL-100W-V36-RAS	0-100W	100-240V	36V	IP65	0-2.8A	90%	4KV	171*53*37mm
	DL-100W-V48-RAS	0-100W	100-240V	48V	IP65	0-2.1A	90%	4KV	171*53*37mm
150W	DL-150W-V12-RAS	0-150W	100-240V	12V	IP65	0-12.5A	91%	4KV	183*63*37mm
	DL-150W-V24-RAS	0-150W	100-240V	24V	IP65	0-6.25A	91%	4KV	183*63*37mm
	DL-150W-V36-RAS	0-150W	100-240V	36V	IP65	0-4.2A	91%	4KV	183*63*37mm
	DL-150W-V48-RAS	0-150W	100-240V	48V	IP65	0-3.15A	91%	4KV	183*63*37mm

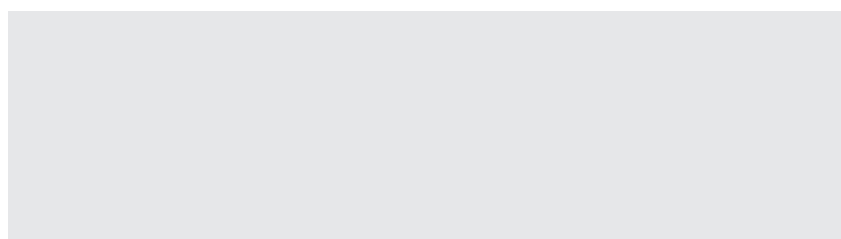

	Product Size					
	L1	L2	L3	W1	W2	H
30W	118mm	-mm	-mm	35mm	-mm	26mm
50W	162mm	-mm	-mm	40mm	-mm	30mm
75W	162mm	-mm	-mm	40mm	-mm	30mm
100W	171mm	-mm	-mm	53mm	-mm	37mm
150W	183mm	-mm	-mm	63mm	-mm	37mm

Input Cable
UL1015 18#AWG Ø8x180mm

Output Cable
UL1015 18#AWG Ø8x180mm

SPD

Surge protector device series

PRODUCT FEATURES

1. Max working voltage:305V,Rated working voltage:24V.
2. Max working current:40A.
3. Surge protection:10KV.
4. Protection level: IP65



Protection Level **IP65**

Cable CCC 1.0MM² 300/500V 105°C

Size 37*42*34mm

LSP10

Surge protector device series

PRODUCT FEATURES

1. Input voltage: 100-277V.
2. Norminal discharge current: (IN) 5KV, 8/20μS.
3. Max. discharge current: (IN) 10KV, 8/20μS.
4. Comply with EN61643-11 standard.
5. Surge Protection: 10KV.

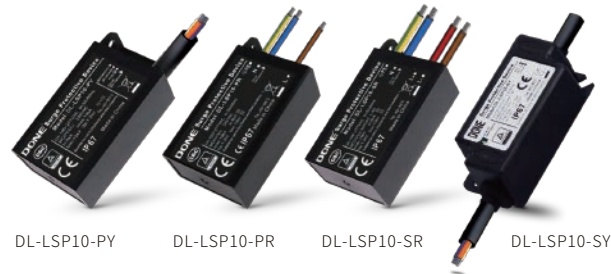

DL-LSP10-PY

DL-LSP10-PR

DL-LSP10-SR

DL-LSP10-SY

Protection Level **IP67**

LSP20

Surge protector device series

PRODUCT FEATURES

1. Input voltage: 100-277V.
2. Norminal discharge current: (IN) 10KV, 8/20μS.
3. Max. discharge current: (IN) 20KV, 8/20μS
4. Comply with EN61643-11 standard
5. Surge Protection: 20KV



DL-LSP20-PY

DL-LSP20-PR

DL-LSP20-SR

DL-LSP20-SY

Protection Level **IP67**

Programming device



1. Intelligent programming accessories USB
2. USB power supply
3. Used with DONE programmer software



Handheld NFC programmer

1. USB power supply
2. integrated NFC module
3. Used with DONE programmer software

Q & A

INPUT VOLTAGE RANGE

When the user sees that the labeled input voltage range on the power supply is 85-265VAC, the actual input voltage is 100-240VAC. When the safety certification is conducted, the so-called strict $\pm 10\%$ test (IEC60950 strict + 6%-10%) will be carried out, so there will be no problem in the use of the power supply drive within the voltage range defined in the specification. The voltage range indicated on the power supply is to meet safety specifications and to ensure proper use of the power supply.

POWER FACTOR

Power Factor Correction for improve the led driver ratio of effective Power and apparent Power at the input end. For products which without PFC, the power factor is only 0.4~0.6 at the input end, models which with active PFC , PF can be more than 0.95. The correlation is as follows:

Apparent power = input voltage x input current (VA)

Effective power = input voltage x input current x power factor (PF)

From the viewpoint of environmental, electric power company must produce more than the apparent power, so that their generating sets can supply to market demands stable, and the actual use of power is the effective power. If the power factor is 0.5, it means that the generator set should produce more than 2VA power, can supply 1W power safely, and its energy efficiency is poor. But if the power factor was improved to 0.95, the generating set of the electric power company need produces power more than 1.06VA, the demand for supply 1W power will be enough, and the energy efficiency is better.

SURGE CURRENT

The switching power supply at the instant of the input power transmission will be a brief (1 / 2-1 power cycle, ex: 60Hz power supply 1 / 120-1 / 60 seconds) of high current (about 20-60A according to the product design, please refer to the product acknowledgment) at the moment of power transmission of the input power supply. After the product is started, the normal current input will be restored, and it will appear at the moment of power transmission at the input power supply every time. This is a normal phenomenon and will not cause the damage of power supply . However, it is not recommended to turn on / off the power supply continuously. In addition, it should be noted that if more than one power supply device is used to start up at the same time, it may cause the protection switch of system distribution to jump off. It is recommended to delay starting up among more than one power supply device, or to use the remote control function of the power product to delay starting up the product sequence.

OUTPUT VOLTAGE ACCURACY

Output voltage accuracy refers to the difference between the actual output voltage and the rated output voltage. This error is the superposition value of line stability and load stability. Normally this parameter at +/-1% line stability is the percentage of the output voltage that deviates from the rated voltage when the input voltage varies between the maximum and minimum allowable range. Load stability is the percentage of the output voltage that deviates from the rated voltage when the output load current varies between the maximum and minimum allowable range.

Efficiency: The ratio of total output power to active input power, expressed as a percentage. That is, $\text{efficiency} = \text{output power} / \text{input power} * 100\%$.

Rated power: refers to the maximum output power of the power supply (voltage V times current A).

Electromagnetic compatibility (EMC) : the ability of a device or system to operate as required in its electromagnetic environment without producing intolerable EMI to any device in its environment.

EMC includes EMI(electromagnetic interference) and EMS(electromagnetic tolerance). The so-called EMI electromagnetic interference refers to the harmful energy transmitted or radiated by the switching power supply. And EMS refers to the ability of the switching power supply to be unaffected by the surrounding electromagnetic environment in the process of performing its due functions.

Ripple: as the dc stable power supply is generally formed by the ac power supply through rectifying and voltage stabilizing links, it is inevitable that there are more or less ac components in the dc stable power. The ac component superimposed on the dc stable power is called ripple.

Output ripple and noise: the amplitude of the output ac voltage from the switching power supply within a specified bandwidth, usually expressed as a millivolt level peak-to-peak or RMS value.

Total Harmonic Distortion is refers to the signal source input, the output signal (harmonic and its frequency doubling component) than the input signal of the additional harmonic component, usually expressed as a percentage. Generally speaking, the total harmonic distortion of this frequency of 1000Hz is the smallest, so many products take the distortion of this frequency as its index. So the test for total harmonic distortion is 1000Hz sound, and the smaller the better.

Overshoot and undershoot: Overshoot is when the first peak or valley value exceeds the set voltage -- the highest voltage for the rising edge and the lowest voltage for the falling edge. Undershoot is the next valley or peak. Excessive overshoot can cause the protective diode to work, leading to premature failure. Excessive undershoot can cause false clock or data errors.

Working environment temperature switch power supply can be reasonable electrical indicators and stability of the working temperature range. Unless specified otherwise, do not assume that the switching power supply can output full power throughout the temperature range, nor that the switching power supply can maintain the same electrical specifications throughout the operating temperature range.

Pulse Width Modulation (PWM) : a method of voltage regulation used in switching power supplies by simply changing the period and duty cycle of the pulse train.