



轨装接线端子选型手册
RAIL-MOUNTED TERMINAL BLOCK



PCB连接器及端子选型手册
PCB CONNECTORS AND TERMINAL BLOCKS



工业开关选型手册
INDUSTRIAL SWITCH



圆形连接器选型手册
CIRCULAR CONNECTOR BLOCK



接口模块选型手册
INTERFACE MODULE



定制部件选型手册
CUSTOMERICED PARTS

PCB连接器及端子选型手册

PCB CONNECTORS AND TERMINAL BLOCKS

V2.3 II

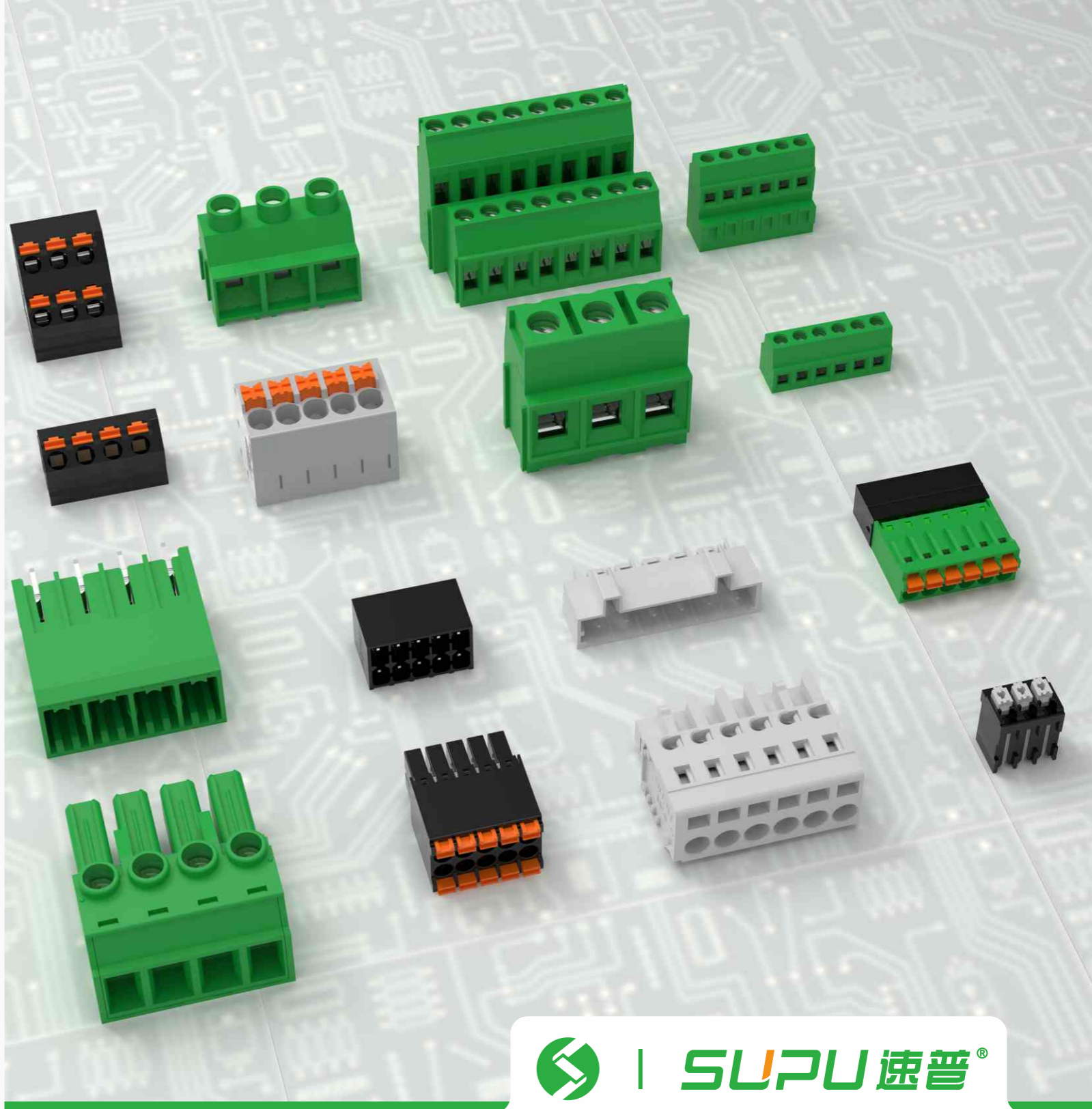

宁波速普电子有限公司
NINGBO SUPU ELECTRONICS CO.,LTD.

地址 | 浙江省慈溪市高新技术产业开发区新兴四路150号
Add | #150,Xinxing No.4 Rd, High-tech Zone ,Cixi, Zhejiang,China.
P.C. | 315303
Service Hotline | 400-626-6336
Tel | 0574-63288158
Fax | 0574-63288170
E-mail | askme@supu.cn
Http | www.supu.com.cn



V2.3 II

PCB连接器及端子选型手册
PCB CONNECTORS AND TERMINAL BLOCKS



宁波速普电子成立于1999年，现有电连接器、工业开关、电子产品、定制化产品四大业务版块，是一家集研发、生产、销售、服务于一体的电气产业全球优秀供应商。

速普产品包括轨装接线端子、PCB连接器、工业开关、圆形连接器、重载连接器、接口模块等。公司产品已通过CQC、UL、VDE、TUV、CE、ROHS、REACH等多项认证。公司已通过ISO9001、ISO14001、ISO/TS22163和IATF16949等管理体系认证。

速普产品广泛应用于电梯、电力、轨道交通、工业自动化、新能源、照明、船舶、仪器仪表、机械设备等领域。自公司创立以来，秉承产品创新与科技前瞻的精神，建立了先进的技术研发中心，已获得国家高新技术企业、国家专精特新小巨人企业、宁波工程技术中心等多项荣誉。

在提供标准产品外，同时为客户带去定制化产品解决方案，有效满足客户个性化需求。速普建立了完善的全球销售网络，产品畅销中国、俄罗斯、德国、西班牙、美国、巴西、日本等100多个国家和地区。

Ningbo Supu Electronics Co., Ltd. was established in 1999, which has been a collection of R&D, production, sales, service in one of the world's outstanding suppliers of electrical industry, with four business sections: electrical connector, industrial switch, electronic products, and customized components.

Supu products include Rail-mounted terminals, PCB connectors, Industrial switches, Circular connectors, Heavy-duty connectors, Interface modules, etc. which have passed CQC, UL, VDE, TUV, CE, ROHS, REACH and other certifications. The company has passed ISO9001, ISO14001, ISO/TS22163 and IATF16949 management system certification.

Supu products are widely used in elevator, electric power, rail transit, industrial automation, new energy, lighting, ships, instruments, mechanical equipment and other fields. Since its establishment, adhering to the spirit of product innovation and technological foresight, the company has established an advanced technology research and development center, which has won many honors such as National High-tech Enterprise, National Specialized and New Small Giant Enterprise, Ningbo Engineering Technology Center, etc.

In addition to providing standard products, Supu also bring customized product solutions to effectively meet customers' personalized needs. Supu has established a perfect global sales network, and its products sell well in more than 100 countries and regions such as China, Russia, Germany, Spain, the United States, Brazil, Japan, etc.

使命 Mission

追求全体员工物质和精神两方面的幸福，提升企业价值，
为人类和社会进步与发展做出贡献
Pursuit happiness of all staff in material & spiritual,
promote the enterprise value, contribute to the progress
& development for human & society



愿景 Corporation Vision

成为全球电气产业经营典范
To be the model of the global electric industry



核心价值观 Core Values

勤奋、创新、内求、利他
Diligence, Innovative, Self-seeking, Altruism



质量方针 Quality Policy

追求全程精益品质 持续改进 超越顾客期望 打造行业品牌
To pursuit full lean quality Continuous improvement Exceed
customers expectations Build industry brand



2023新启航 New sail in 2023

开启新征程，共创新辉煌
New journey, New success.
——系统性目标管理，数字化高效运营，打造坚实经营体质
—— Systematic target management,
Digital and efficient operation,
To create a solid management constitution.



MC 系列连接器 MC Series Terminal Blocks

该系列产品采用压线框螺钉连接、正面螺钉连接、Push-in弹簧连接等多种接线技术。客户可根据需求实现线到线，线到板、板到线、板到板的布线方式。该系列产品可以连接0.2mm²到35mm²所有类型导线，间距从2.5mm至20mm,广泛应用于电力、自动化、轨道交通等行业。

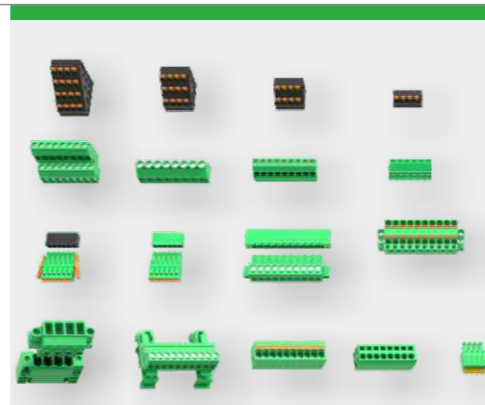

MC系列插拔式接线端子选型编码 MC series pluggable terminal blocks coding rule 页码/Page: 01-58

MC系列孔型接线端子 MC series female connector

MC - R A 3.81 H 15 C K - OG

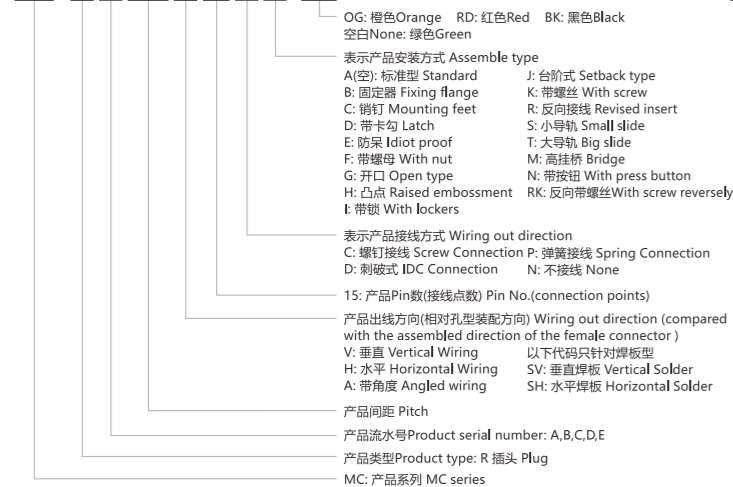

MC系列固定式接线端子 MC series fixed terminal block

MC - T D 5.08 H 15 C - * - OG



MC系列针型接线端子 MC series male connector

MC D - P A 3.81 V 15 * - F - OG



PCB弹簧端子系列/PCB spring terminal series
产品类型/Product type
产品间距/Pitch
颜色, 位数, 通道/Color, Poles No.

标记字符 Marked Numbers:
可按客户要求打印字符, 下表字符打印在原定货号后加后缀。
For more product information, please contact us! Can mark according to customer's request.
The number in the below list can be added following the original order No.

打印字符描述 Description of marked numbers	产品 Product	后缀 Marking
1 2 3 4 ... 23 24		/001
1 2 ⊕ 4 ... 23 24		/002
1 ~ 3 4 ... 23 24		/003
1 ~ ⊕ 4 ... 23 24		/004
按客户要求而定 According to customers' request.		/005

间距 Pitch [mm]	额定电流 Rated current [A]	额定电压 Rated voltage [V]	订货号 Order No.	页码 Page	例图 Picture
2.5	4	160	MC-RJ2.5HXXP-0001	001	
2.5	4	160	MC-PA2.5HXX-0002 MC-PA2.5VXX-0002	002	
			MC-DPA2.5VXX-0002 MC-DPA2.5HXX-0002		
3.5	8	160	MC-RA3.5HXXC-0001 MC-RA3.5HXXC-K-0001 MC-RA3.5HXXC-I-0001	001	
			MC-RE3.5VXXC-0001 MC-RE3.5VXXC-K-0001 MC-RE3.5VXXC-I-0001 MC-RE3.5VXXC-RK-0001		
3.5	8	160	MC-RJ3.5HXXP-0001 MC-RJ3.5HXXP-K-0001 MC-RJ3.5HXXP-I-0001	002	
			MC-DRD3.5HXXP MC-DRD3.5HXXP-K		
3.5	8	160	MC-RF3.5HXXP-0001 MC-RF3.5HXXP-K-0001 MC-RF3.5HXXP-I-0001 MC-RF3.5HXXP-D-0001	004	
			MC-DRF3.5HXXP-0001 MC-DRF3.5HXXP-D-0001 MC-DRF3.5HXXP-K-0001		
3.5	8	160	MC-DPAN3.5VXX-BK-2600 MC-DPAN3.5VXX-D-BK-2600 MC-DPAN3.5VXX-F-BK-2600 MC-DPAN3.5HXX-BK-2600 MC-DPAN3.5HXX-D-BK-2600 MC-DPAN3.5HXX-F-BK-2600	004	
			MC-PF3.5HXXP-0001 MC-PF3.5HXXP-B-0001 MC-PF3.5HXXP-D-0001 MC-PF3.5HXXP-DB-0001 MC-PF3.5HXXP-F-0001 MC-PF3.5HXXP-FB-0001 MC-PF3.5HXXP-I-0001 MC-PF3.5HXXP-IB-0001 MC-PF3.5HXXP-K-0001		
3.5	8	160	MC-PA3.5VXX-0002 MC-PA3.5VXX-D-0002 MC-PA3.5VXX-F-0002 MC-PA3.5VXX-I-0002 MC-PA3.5VXX-L-0002 MC-PA3.5HXX-0002 MC-PA3.5HXX-D-0002 MC-PA3.5HXX-F-0002 MC-PA3.5HXX-I-0002 MC-PA3.5HXX-L-0002	005 - 006	
			MC-DRT3.5HXXP-A-0001 MC-DRT3.5HXXP-K-0001 MC-DRT3.5HXXP-I-0001		

间距 Pitch [mm]	额定电流 Rated current [A]	额定电压 Rated voltage [V]	订货号 Order No.	页码 Page	例图 Picture
3.5	8	160	MC-DPT3.5VXX-BK-2000 MC-DPT3.5VXX-F-BK-2000 MC-DPT3.5HXX-I-BK-2000 MC-DPT3.5HXX-BK-2000 MC-DPT3.5HXX-F-BK-2000 MC-DPT3.5HXX-I-BK-2000	008	
3.5	13.5	160	MC-DRG3.5HXXP-0001 MC-DRG3.5HXXP-K-0001 MC-DRG3.5HXXP-I-0001	007	
3.5	10	125	MC-DPG3.5VXX-3500 MC-DPG3.5VXX-F-3500 MC-DPG3.5VXX-I-3500 MC-DPG3.5HXX-3500 MC-DPG3.5HXX-F-3500 MC-DPG3.5HXX-I-3500	008	
3.81	8	160	MC-RA3.81HXXC-0001 MC-RA3.81HXXC-K-0001 MC-RA3.81HXXC-I-0001	009	
3.81	8	160	MC-RAF3.81HXXC-0001 MC-RAF3.81HXXC-K-0001 MC-RAF3.81HXXC-I-0001	010	
3.81	8	160	MC-RE3.81VXXC-0001 MC-RE3.81VXXC-K-0001 MC-RE3.81VXXC-I-0001 MC-RE3.81VXXC-R-0001 MC-RE3.81VXXC-RK-0001	009	
3.81	8	160	MC-RJ3.81HXXP-0001 MC-RJ3.81HXXP-K-0001 MC-RJ3.81HXXP-I-0001	010	
3.81	8	160	MC-RF3.81HXXP-0001 MC-RF3.81HXXP-K-0001 MC-RF3.81HXXP-I-0001 MC-RF3.81HXXP-D-0001	011	
3.81	8	160	MC-DRF3.81HXXP-0001 MC-DRF3.81HXXP-D-0001 MC-DRF3.81HXXP-K-0001	012	
3.81	8	160	MC-DPAN3.81VXX-BK-2600 MC-DPAN3.81VXX-D-BK-2600 MC-DPAN3.81VXX-F-BK-2600 MC-DPAN3.81HXX-BK-2600 MC-DPAN3.81HXX-D-BK-2600 MC-DPAN3.81HXX-F-BK-2600	011	
3.81	8	160	MC-RU3.81SHXX-0001 MC-RU3.81SHXX-F-0001 MC-RU3.81SVXX-0001 MC-RU3.81SVXX-F-0001	012	
3.81	8	160	MC-PF3.81HXXP-0001 MC-PF3.81HXXP-B-0001 MC-PF3.81HXXP-D-0001 MC-PF3.81HXXP-DB-0001 MC-PF3.81HXXP-F-0001 MC-PF3.81HXXP-FB-0001 MC-PF3.81HXXP-I-0001 MC-PF3.81HXXP-IB-0001 MC-PF3.81HXXP-K-0001	013 - 014	
			MC-PA3.81VXX-0002 MC-PA3.81VXX-F-0002 MC-PA3.81VXX-I-0002 MC-PA3.81VXX-L-0002 MC-PA3.81HXX-0002 MC-PA3.81HXX-F-0002 MC-PA3.81HXX-I-0002 MC-PA3.81HXX-L-0002 MC-PA3.81AXX-0002 MC-PA3.81AXX-F-0002 MC-PA3.81AXX-I-0002		

间距 Pitch [mm]	额定电流 Rated current [A]	额定电压 Rated voltage [V]	订货号 Order No.	页码 Page	例图 Picture
3.81	8	160	MC-DPA3.81VXX-0002 MC-DPA3.81VXX-F-0002 MC-DPA3.81HXX-0002 MC-DPA3.81HXX-F-0002	015	
3.81	8	160	MC-DPAB3.81VXX-0001 MC-DPAB3.81VXX-F-0001 MC-DPAB3.81VXX-I-0001 MC-DPAB3.81HXX-0001 MC-DPAB3.81HXX-F-0001 MC-DPAB3.81HXX-I-0001	016	
3.81	8	160	MC-PB3.81HXXC-0001 MC-PB3.81HXXC-B-0001 MC-PB3.81HXXC-F-0001 MC-PB3.81HXXC-FB-0001 MC-PB3.81HXXC-I-0001 MC-PB3.81HXXC-IB-0001 MC-PB3.81HXXC-K-0001 MC-PB3.81HXXC-KB-0001	015 - 016	
5.0	18	320	MC-RB5.0HXXC-0001 MC-RB5.0HXXC-K-0001 MC-RB5.0HXXC-I-0001	017	
5.0	18	320	MC-RBT5.0HXXC-0001 MC-RBT5.0HXXC-K-0001 MC-RBT/TS.0HXXC-0001 MC-RBT/TS.0HXXC-K-0001	018	
5.0	12	320	MC-RE5.0VXXC-0001 MC-RE5.0VXXC-K-0001 MC-RE5.0VXXC-I-0001 MC-RE5.0VXXC-R-0001 MC-RE5.0VXXC-RK-0001	017	
5.0	12	320	MC-RJ5.0HXXP-0001 MC-RJ5.0HXXP-K-0001 MC-RJ5.0HXXP-I-0001 MC-RJ5.0HXXP-D-0001	018	
5.0	18	320	MC-PA5.0VXX-0002 MC-PA5.0VXX-D-0002 MC-PA5.0VXX-F-0002 MC-PA5.0VXX-G-0002 MC-PA5.0VXX-I-0002 MC-PA5.0HXX-0002 MC-PA5.0HXX-D-0002 MC-PA5.0HXX-F-0002 MC-PA5.0HXX-G-0002 MC-PA5.0HXX-I-0002	019	
5.0	10	320	MC-DPA5.0HXX-0002 MC-DPA5.0HXX-F-0002 MC-DPA5.0VXX-0002 MC-DPA5.0VXX-F-0002	019	
5.0	12	320	MC-PAL5.0H02-0002 MC-PAL5.0H03-0002 MC-PAL5.0H04-0002	020	
			MC-PAR5.0H02-0002 MC-PAR5.0H03-0002 MC-PAR5.0H04-0002		
5.0	20	320	MC-ROX5.0HXXP-0001 MC-ROY5.0HXXP-0001	021	
5.0	15	320	MC-ROX5.0HXXP-0002	021	

间距 Pitch [mm]	额定电流 Rated current [A]	额定电压 Rated voltage [V]	订货号 Order No.	页码 Page	例图 Picture
5.0	15	320	MC-POX5.0HXX-0001 MC-POY5.0HXX-0001	022	
5.0	15	320	MC-POX5.0HXX-0002	022	
5.08	8	320	MC-RA5.08HXXC-0001 MC-RA5.08HXXC-K-0001 MC-RA5.08HXXC-I-0001	021	
5.08	18	320	MC-RB5.08HXXC-0001 MC-RB5.08HXXC-K-0001 MC-RB5.08HXXC-I-0001	022	
5.08	12	320	MC-RB5.08HXXB-0001 MC-RB5.08HXXB/100-0001 MC-RB5.08HXXB-I-0001 MC-RB5.08HXXB-I/100-0001 MC-RB5.08HXXB-K-0001 MC-RB5.08HXXB-K/100-0001	023	
5.08	18	320	MC-RBF5.08HXXC-0001 MC-RBF5.08HXXC-K-0001 MC-RBF5.08HXXC-I-0001	024	
5.08	5		MC-RB5.08-03-3000	023	
	10	320	MC-RB5.08-10-3000		
	12		MC-RB5.08-25-3000		
5.08	12	320	MC-RE5.08VXXC-0001 MC-RE5.08VXXC-K-0001 MC-RE5.08VXXC-I-0001 MC-RE5.08VXXC-R-0001 MC-RE5.08VXXC-RK-0001	024	
5.08	12	320	MC-RN5.08VXXP-0001 MC-RN5.08VXXP-K-0001 MC-RN5.08VXXP-R-0001 MC-RN5.08VXXP-RK-0001	025	
5.08	12	320	MC-RJ5.08HXXP-0001 MC-RJ5.08HXXP-D-0001 MC-RJ5.08HXXP-I-0001 MC-RJ5.08HXXP-K-0001	026	
5.08	12	320	MC-RJT5.08HXXP-0001 MC-RJT5.08HXXC-K-0001	025	
5.08	18	320	MC-RS5.08HXXP-0001 MC-RS5.08HXXP-K-0001 MC-RS5.08HXXP-I-0001	026	
5.08	12	320	MC-DRJ5.08HXXP-0001 MC-DRJ5.08HXXP-K-0001 MC-DRJ5.08HXXP-I-0001	027	
5.08	18	320	MC-RP5.08HXXP-0001 MC-RP5.08HXXP-K-0001 MC-RP5.08HXXP-I-0001	028	

间距 Pitch [mm]	额定电流 Rated current [A]	额定电压 Rated voltage [V]	订货号 Order No.	页码 Page	例图 Picture
5.08	12	300	MC-PJ5.08HXXP-0001 MC-PJ5.08HXXP-B-0001 MC-PJ5.08HXXP-D-0001 MC-PJ5.08HXXP-DB-0001 MC-PJ5.08HXXP-F-0001 MC-PJ5.08HXXP-I-0001 MC-PJ5.08HXXP-K-0001	027 - 028	
5.08	18	320	MC-PA5.08HXX-0002 MC-PA5.08HXX-D-0002 MC-PA5.08HXX-F-0002 MC-PA5.08HXX-G-0002 MC-PA5.08HXX-I-0002 MC-PA5.08VXX-0002 MC-PA5.08VXX-D-0002 MC-PA5.08VXX-F-0002 MC-PA5.08VXX-G-0002 MC-PA5.08VXX-I-0002	029 - 030	
5.08	12	320	MC-PB5.08HXXC-0001 MC-PB5.08HXXC-B-0001 MC-PB5.08HXXC-F-0001 MC-PB5.08HXXC-FB-0001 MC-PB5.08HXXC-I-0001 MC-PB5.08HXXC-IB-0001 MC-PB5.08HXXC-K-0001 MC-PB5.08HXXC-KB-0001 MC-PB5.08HXXC-S-0001 MC-PB5.08HXXC-SF-0001 MC-PB5.08HXXC-SI-0001 MC-PB5.08HXXC-SK-0001	029 - 030	
5.08	8	320	MC-PD5.08HXX-0001 MC-PD5.08HXX-F-0001 MC-PD5.08HXX-I-0001 MC-PD5.08VXX-0001 MC-PD5.08VXX-F-0001 MC-PD5.08VXX-I-0001	031	
5.08	10	320	MC-DPA5.08HXX-0002 MC-DPA5.08HXX-F-0002 MC-DPA5.08VXX-0002 MC-DPA5.08VXX-F-0002	032	
5.08	10	320	MC-DPAB5.08HXX-0001 MC-DPAB5.08HXX-F-0001 MC-DPAB5.08HXX-G-0001 MC-DPAB5.08HXX-I-0001 MC-DPAB5.08VXX-0001 MC-DPAB5.08VXX-F-0001 MC-DPAB5.08VXX-G-0001 MC-DPAB5.08VXX-I-0001	031 - 032	
5.08	16	320	MC-RU5.08SHXX-0001 MC-RU5.08SHXX-F-0001 MC-RU5.08SVXX-0001 MC-RU5.08SVXX-F-0001	033	
5.08	12	320	MC-RH5.08HXXC-B-0001 MC-RH5.08HXXC-T-0001	034	
7.5	18	630	MC-RB7.5HXXC-0001 MC-RB7.5HXXC-K-0001 MC-RB7.5HXXC-I-0001	033	
7.5	18	630	MC-RE7.5VXXC-0001 MC-RE7.5VXXC-K-0001 MC-RE7.5VXXC-I-0001 MC-RE7.5VXXC-RK-0001	034	

间距 Pitch [mm]	额定电流 Rated current [A]	额定电压 Rated voltage [V]	订货号 Order No.	页码 Page	例图 Picture
7.5	12	630	MC-RJ7.5HXXP-0001 MC-RJ7.5HXXP-K-0001 MC-RJ7.5HXXP-I-0001	035	
7.5	18	630	MC-PA7.5HXX-0002 MC-PA7.5HXX-F-0002 MC-PA7.5HXX-G-0002 MC-PA7.5HXX-I-0002 MC-PA7.5VXX-0002 MC-PA7.5VXX-F-0002 MC-PA7.5VXX-G-0002 MC-PA7.5VXX-I-0002	035 - 036	
7.5	20	630	MC-ROX7.5HXXP-0001 MC-ROY7.5HXXP-0001	037	
7.5	15	630	MC-POX7.5HXX-0001 MC-POY7.5HXX-0001	038	
7.62	18	630	MC-RB7.62HXXC-0001 MC-RB7.62HXXC-K-0001 MC-RB7.62HXXC-I-0001	037	
7.62	18	630	MC-RE7.62VXXC-0001 MC-RE7.62VXXC-K-0001 MC-RE7.62VXXC-I-0001 MC-RE7.62VXXC-R-0001 MC-RE7.62VXXC-RK-0001	038	
7.62	12	630	MC-RJ7.62HXXP-0001 MC-RJ7.62HXXP-K-0001 MC-RJ7.62HXXP-I-0001	039	
7.62	18	630	MC-PA7.62HXX-0002 MC-PA7.62HXX-F-0002 MC-PA7.62HXX-G-0002 MC-PA7.62HXX-I-0002 MC-PA7.62VXX-0002 MC-PA7.62VXX-F-0002 MC-PA7.62VXX-G-0002 MC-PA7.62VXX-I-0002	039 - 040	
7.62	12	630	MC-PB7.62HXXC-0001 MC-PB7.62HXXC-F-0001 MC-PB7.62HXXC-K-0001 MC-PB7.62HXXC-I-0001 MC-PB7.62HXXC-B-0001 MC-PB7.62HXXC-FB-0001 MC-PB7.62HXXC-IB-0001 MC-PB7.62HXXC-KB-0001	041 - 042	
7.62	41	1000	MC-RHH7.62HXXC-0001 MC-RHH7.62HXXC-K-0001	041	
7.62	41	1000	MC-RQ7.62HXXP-0001 MC-RQ7.62HXXP-K-0001	042	

间距 Pitch [mm]	额定电流 Rated current [A]	额定电压 Rated voltage [V]	订货号 Order No.	页码 Page	例图 Picture
7.62	20	630	MC-PH7.62HXX-0001 MC-PH7.62HXX-F-0001 MC-PH7.62VXX-0001 MC-PH7.62VXX-F-0001	043	
7.62	20	630	MC-RH7.62HXX-0001 MC-RH7.62HXX-K-0001	044	
7.62	41	630	MC-PHH7.62HXX-0001 MC-PHH7.62HXX-I-0001 MC-PHH7.62HXX-F-0001 MC-PHH7.62HXX-F-0030 MC-PHH7.62VXX-0001 MC-PHH7.62VXX-I-0001 MC-PHH7.62VXX-F-0001 MC-PHH7.62VXX-F-0030	043 - 044	
10.16	76	1000	MC-RHH10.16HXXC-0001 MC-RHH10.16HXXC-K-0001	045	
10.16	76	1000	MC-PH10.16HXX-0001 MC-PH10.16HXX-F-0001 MC-PH10.16VXX-0001 MC-PH10.16VXX-F-0001	045	
3.5	17.5	200	MC-TB3.5HXXP-BK-0001 MC-TB3.5HXXP-BK-1600 MC-TB3.5VXXP-BK-0001 MC-TB3.5VXXP-BK-1600	046	
3.5	17.5	160	MC-TB3.5HXXP-BK-0001-SMT MC-TB3.5VXXP-BK-0001-SMT	046	
3.81	8	160	MC-TM3.81HXXC-0001	046	
3.81	8	160	MC-DTM3.81HXXC-0001	047	
3.81	8	160	MC-TTM3.81HXXC-0001	047	
3.81	10	200	MC-TM3.81BXXC-0001	047	
3.81	12	160	MC-TE3.81HXXC-0001	047	
3.81	12	160	MC-TEH3.81HXXC-0001	047	







间距 Pitch [mm]	额定电流 Rated current [A]	额定电压 Rated voltage [V]	订货号 Order No.	页码 Page	例图 Picture
3.81	12	160	MC-DTEH3.81HXXC-0001	048	
5.0	17.5	320	MC-TI5.0HXXP-BK-0001 MC-TI5.0HXXP-BK-1600 MC-TI5.0VXXP-BK-0001 MC-TI5.0VXXP-BK-1600	048	
5.0	17.5	320	MC-TI5.0HXXP-BK-0001-SMT MC-TI5.0VXXP-BK-0001-SMT	048	
5.0	14	320	MC-TE5.0HXXC-0001	049	
5.0	13.5	320	MC-TEH5.0HXXC-0001	049	
5.0	14	320	MC-DTE5.0HXXC-0001	049	
5.0	24	400	MC-TD5.0HXXC-0001	049	
5.0	24	400	MC-TD5.0AXXC-0001	049	
5.0	24	400	MC-DTD5.0HXXC-0001	050	
5.0	24	400	MC-TF5.0HXXC-0001	050	
5.0	24	400	MC-TF5.0AXXC-0001	050	
5.0	24	400	MC-DTF5.0HXXC-0001	050	
5.0	24	320	MC-TC5.0VXXP-N-GY-0001	050	
5.0	24	320	MC-TC5.0VXXP-0001 MC-TC5.0HXXP-0001	051	

间距 Pitch [mm]	额定电流 Rated current [A]	额定电压 Rated voltage [V]	订货号 Order No.	页码 Page	例图 Picture
5.0	17.5	320	MC-TP/B5.0AXXP-BK-0001 MC-TP/F5.0AXXP-BK-0001 MC-DTP5.0AXXP-BK-0001 MC-TTP5.0AXXP-BK-0001 MC-FTP5.0AXXP-BK-0001	051	
5.0	24	320	MC-TS5.0HXXP-0001	051	
5.08	20	320	MC-TC5.08AXXP-0001	052	
5.08	20	320	MC-DTC5.08AXXP-0001	052	
5.08	14	320	MC-TE5.08HXXC-0001	052	
5.08	13.5	320	MC-TEH5.08HXXC-0001	052	
5.08	17.5	320	MC-TE5.08AXXC-0001	052	
5.08	13.5	400	MC-TE5.08BXXC-0001	053	
5.08	14	320	MC-DTE5.08HXXC-0001	053	
5.08	24	400	MC-TD5.08HXXC-0001	053	
5.08	24	400	MC-TD5.08AXXC-0001	053	
5.08	24	400	MC-DTD5.08HXXC-0001	053	
5.08	24	400	MC-TTD5.08HXXC-0001	054	
5.08	24	400	MC-TF5.08HXXC-0001	054	

间距 Pitch [mm]	额定电流 Rated current [A]	额定电压 Rated voltage [V]	订货号 Order No.	页码 Page	例图 Picture
5.08	24	400	MC-TF5.08AXXC-0001	054	
5.08	20	400	MC-TF5.08CXXC-0001	054	
5.08	24	400	MC-DTF5.08HXXC-0001	054	
5.08	24	400	MC-TTF5.08HXXC-0001	055	
5.08	15	400	MC-TC5.08VXXP-N-0001	055	
6.35	32	630	MC-TTF6.35HXXC-0001	055	
6.35	41	1000	TH/F6.35HXXC-0001	055	
7.5	32	630	MC-TH7.5HXXC-0001	055	
7.5	41	1000	MC-TC7.5HXXP-0001 MC-TC/B7.5HXXP-0001(W针脚) TC/B7.5HXXP-0001(M针脚) MC-TC7.5VXXP-0001 MC-TC/F7.5VXXP-0001 (W针脚) MC-TC/F7.5VXXP-0001 (M针脚)	056	
7.62	15	630	MC-TC7.62VXXP-N-0001	056	
7.62	24	630	MC-TD7.62HXXC-0001	056	
7.62	24	630	MC-TF7.62HXXC-0001	056	
7.62	32	630	MC-TG7.62HXXC-0001	057	
9.52	32	1000	MC-TG9.52HXXC-0001	057	

间距 Pitch [mm]	额定电流 Rated current [A]	额定电压 Rated voltage [V]	订货号 Order No.	页码 Page	例图 Picture
9.52	32	1000	MC-TH9.52HXXC-0001	057	
9.52	32	1000	MC-TH/F9.52HXXC-0001	057	
10.16	57	1000	MC-TJ10.16HXXC-0001	057	
10.16	76	1000	MC-TH10.16HXXC-0001 MC-TH/B10.16H01C-0001 MC-TH/F10.16H01C-0001	058	
15	125	1000	MC-TK15HXXC-0001 MC-TK15HXXC-B-0001 MC-TK15H01C-BL-0001 MC-TK15H01C-BR-0001	058	
5.0	17.5	320	2352XX/010 2352XX	059	
7.5	17.5	630	2353XX/010 2353XX	059	
10.0	17.5	1000	2354XX/010 2354XX	059	
3.5	17.5	160	2393XX/010 2393XX	059	
5.0	24	320	2391XX	059	
7.5	24	630	2392XX	060	
5.08	24	320	23915X	060	

间距 Pitch [mm]	额定电流 Rated current [A]	额定电压 Rated voltage [V]	订货号 Order No.	页码 Page	例图 Picture
7.62	24	630	23925X	060	
5.0	32	320	2452XX/020 2452XX	060	
7.5	32	630	2453XX/020 2453XX	060	
10.0	32	1000	2454XX/020 2454XX	061	
7.5	41	630	2463XX/020 2463XX	061	
10.0	41	1000	2464XX/020 2464XX	061	
3.5	8	160	2501XX 2502XX	061	
5.0	10	320	2505XX	061	
5.0	24	320	2554XX	062	
7.5	24	630	2555XX	062	
5.0	24	320	2563XX 2567XX	062	
7.5	24	320	2564XX 2568XX	062	

间距 Pitch [mm]	额定电流 Rated current [A]	额定电压 Rated voltage [V]	订货号 Order No.	页码 Page	例图 Picture
10.0	24	1000	2569XX	062	
5.0	21	320	2572XX	063	
7.5	21	630	2573XX	063	
10.0	21	1000	2574XX	063	
5.0	21	320	2582XX	064	
7.5	21	630	2583XX	064	

MCS多用途弹簧连接器

MCS Series Connectors with Spring-cage Clamp

该系列产品采用通用型笼式弹簧接线技术，导线无需预处理。可实现线到板、线到线、板到线、板到板之间的电力和信号传输，可提供销钉固定、卡接、螺钉固定等多种固定方式，产品已通过UL、TUV、CE、CQC认证。



MCS多用途弹簧连接器选型编码

MCS Series Connectors with Spring-cage Clamp coding rule

4 50 2 02 / 0 1 1 - 00 D

- A-Z: 表示延伸产品识别码 The coding for the extended parts
- 00-99: 表示产品规格延伸 (见附表一) The extended parts
- 0-9: 表示喷码样式 Printing type
- 0-9: 表示结构特性 Structure feature
- 1: 带固定器 With fixing flange 3: 带销钉 With mounting feet 6: 穿墙固定器 With wall-through fixing flange
- 2: 开口型 Open type 5: 带卡接钩 With latch
- 0-9: 表示护线板类型 Protection plate type
- 00-99: 表示位数结合前面四位数 Poles number ,combine with the four numbers ahead
- 02~24 52~74
- 2-24位 2-24位
- 0-9: 表示产品类型 Products type
- 1.孔型连接器 Female connector
- 2.直型焊针插座 Straight pin socket
- 3.弯型焊针插座 angled pin socket
- 4.针型连接器 Male connector
- 6.孔型连接器-防反插 Female connector protected against mismatching
- 7.直型焊针插座-防反插 Straight pin socket protected against mismatching
- 8.弯型焊针插座-防反插 Angled pin socket protected against mismatching
- 9.针型连接器-防反插 Male connector protected against mismatching
- 5.护线盒等附件 Accessories including relief housing
- 00-99: 表示间距 Pitch
- 25: 2.5mm 38: 3.81mm 58: 5.08mm 78: 7.62mm
- 35: 3.5mm 50: 5.0mm 75: 7.5mm
- 4: 弹簧连接器系列 Spring cage connector series

页码/Page: 65-88

00 00-99: 表示产品规格延伸 (附表一) The extended parts

代码	含义
00	带接地加长针(适用于3位、4位、5位中间一位用长针) With lengthened grounding pin (applied in 3pole, 4pole, 5pole, the middle one is the lengthened pin)
01	带焊针(3.8mm) With solder pin 3.8mm
02	带焊针(3.8mm), 带接地加长针 With solder pin 3.8mm, the lengthened grounding pin
03	焊针尺寸1.2*1.2mm, 长度3.8mm, 带接地加长针 With solder pin 1.2*1.2mm, pin length 3.8mm, the lengthened grounding pin
04	焊针尺寸1.2*1.2mm, 长度3.8mm With solder pin 1.2*1.2mm, pin length 3.8mm
05	焊针尺寸1.2*1.2mm, 带接地加长针 With solder pin 1.2*1.2mm, the lengthened grounding pin
06	焊针尺寸1.2*1.2mm With solder pin 1.2*1.2mm
...	...

间距 Pitch [mm]	额定电流 Rated current [A]	额定电压 Rated voltage [V]	订货号 Order No.	页码 Page	例图 Picture
2.5	4	160	4251XX 4251XX/050	069	
2.5	4	160	4252XX 4253XX	070	
2.5	4	160	4254XX	070	
3.5	10	160	4351XX 4351XX/010 4351XX/050	069	
3.5	10	160	4352XX 4352XX-01D 4353XX 4358XX	070	

间距 Pitch [mm]	额定电流 Rated current [A]	额定电压 Rated voltage [V]	订货号 Order No.	页码 Page	例图 Picture
3.5	10	160	4354XX 4354XX/010	071	
3.5	10	160	4355XX 4355XX/030	072	
3.81	10	160	4381XX 4381XX/050	071	
3.81	10	160	4382XX 4383XX	072	
3.81	10	160	4384XX 4384XX/010	071	

间距 Pitch [mm]	额定电流 Rated current [A]	额定电压 Rated voltage [V]	订货号 Order No.	页码 Page	例图 Picture
5.0	12	320	4501XX 4501XX/010 4501XX/030 4501XX/050	072	
5.0	12	320	4502XX 4502XX/110 4502XX-01D 4502XX-03D 4502XX-04D 4502XX-05D 4502XX-06D 4503XX 4503XX/00D 4503XX-03D 4503XX-04D	073	
5.0	12	320	4504XX 4504XX/010 4504XX/030 4504XX/060	073	
5.0	12	320	45015X 45015X/010 45015X/030	074	
5.0	12	320	45025X 45025X/110 45035X	075	
5.0	12	320	45046X 45046X/010 45043X 45043X/010	076	
5.0	12	320	4506XX 4506XX/010 4506XX/030 4506XX/050	075	
5.0	12	320	4509XX 4509XX/010 4509XX/030 45043X/010	076	
5.0	12	320	4507XX 4507XX/110 4507XX-00D 4507XX-01D 4507XX-03D 4507XX-04D 4507XX-05D 4507XX-06D 4508XX	077	
5.0	12	320	45065X 45065X/010 45065X/030	077	
5.0	12	320	45075X 45075X/110 45085X	078	
5.08	12	320	4581XX 4581XX/010 4581XX/030 4581XX/050	079	
5.08	12	320	4582XX 4582XX-01D 4583XX 4583XX-00D	080	

间距 Pitch [mm]	额定电流 Rated current [A]	额定电压 Rated voltage [V]	订货号 Order No.	页码 Page	例图 Picture
5.08	12	320	4584XX 4584XX/010 4584XX/030 4584XX/060	079	
5.08	12	320	45825X 45835X	080	
5.08	12	320	45846X 45846X/010 45843X 45843X/010	081	
7.5	16	500	4751XX 4751XX/010 4751XX/030 4751XX/050	082	
7.5	12	500	4752XX 4752XX-03D 4752XX-04D 4752XX-05D 4752XX-06D 4753XX 4753XX-03D 4753XX-04D	081	
7.5	16	500	4754XX 4754XX/010 4754XX/030 4754XX/060	083	
7.5	16	500	47525X 47535X	084	
7.5	16	500	47546X 47546X/010 47543X 47543X/010	083	
7.5	16	500	4756XX 4756XX/010 4756XX/030 4756XX/050	084	
7.5	12	500	4757XX 4757XX-00D 4757XX-02D 4757XX-03D 4757XX-04D 4757XX-06D 4758XX-06D	085	
7.5	16	500	4759XX 4759XX/010 4759XX/030 4759XX/060	085	
7.5	16	500	47575X 47585X	086	

间距 Pitch [mm]	额定电流 Rated current [A]	额定电压 Rated voltage [V]	订货号 Order No.	页码 Page	例图 Picture
7.62	16	500	4781XX 4781XX/010 4781XX/030 4781XX/050	087	
7.62	16	500	4782XX 4782XX-04D 4782XX-06D 4783XX 4783XX-04D	088	

间距 Pitch [mm]	额定电流 Rated current [A]	额定电压 Rated voltage [V]	订货号 Order No.	页码 Page	例图 Picture
7.62	16	500	4784XX 4784XX/010 4784XX/030 4784XX/060	087	
7.62	16	500	47846X 47846X/010 47843X 47843X/010	088	

变压器专用端子
Transformer Terminal Blocks

变压器专用端子专门针对变压器的接线和类似接线应用而设计的接线端子。结构设计兼顾了变压器接线中接线方便和接线牢固的需求，可以快速的安装在2x10mm的导轨上。产品设计制造符合IEC/EN60998、UL1059等国际标准，并通过CQC、UL、VDE、CE认证。

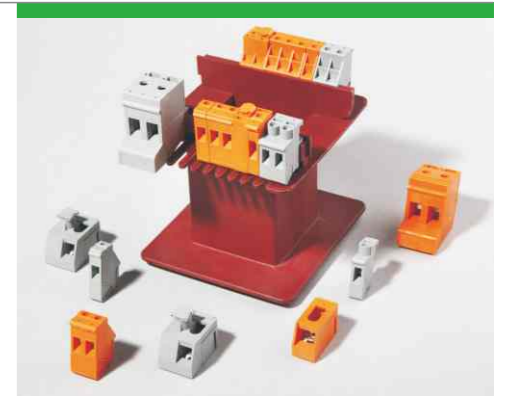

页码/Page: 91-94

订货号规则/Order number rule



B系列冷压式孔型/针型连接器

Series B Connectors With Male/Female Ferrule

B系列冷压式孔型/针型连接器，此类产品与导线的连接器采用机械冷压连接，相互对插采用金属弹性插接连接，也可以直接焊接于PCB板之上，操作所需工具简单，使用方便，接线密度高。广泛应用于各种需要高密度电力和信号连接的位置。产品设计制造符合IEC/EN61984、UL1977等国际标准，并通过TUV、CE认证。



页码/Page: 89-90

订货号规则/Order number rule

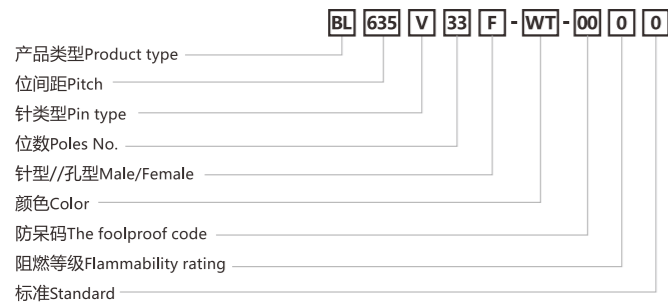

金属件订货号规则
Metallic parts order number rule

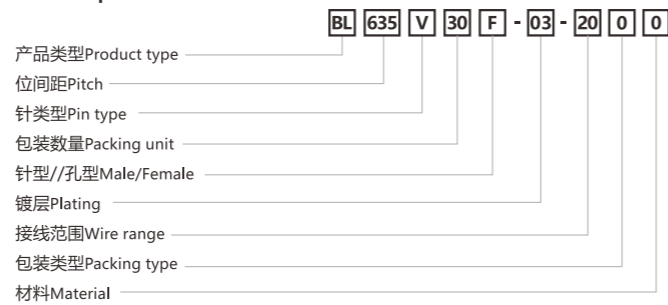

间距 Pitch [mm]	额定电流 Rated current [A]	额定电压 Rated voltage [V]	订货号 Order No.	页码 Page	例图 Picture
6.35	12	600	BL635VXXF-WT-0000 BL635VXXF-WT-0000 BL635VXXM-WT-0000 BL635VXXM-WT-0000	089	
6.35	12	600	BP635VXXM-WT-0000 BP635VXXM-WT-0000 BP635VXXF-WT-0000 BP635VXXF-WT-0000	089	
12	600	600	BL635V30M-03-2000	089	
12	600	600	BL635V30F-03-2000	089	

间距 Pitch [mm]	额定电流 Rated current [A]	额定电压 Rated voltage [V]	订货号 Order No.	页码 Page	例图 Picture
12	600	600	BL635V30M-03-0800	089	
12	600	600	BL635V30F-03-0800	089	
6.35	12	600	BL635V34F-WT-0000-XX BL635V34M-WT-0000-XX	090	

间距 Pitch [mm]	额定电流 Rated current [A]	额定电压 Rated voltage [V]	订货号 Order No.	页码 Page	例图 Picture
32	600	600	620111 620112	091	
24	600	600	620121 620122	091	
10	600	600	620151 620152	091	
32	600	600	620171 620172	091	
32	600	600	620181 620182	091	
10	600	600	620161 620162	091	
32	600	600	620211 620213 620212 620217	092	
32	600	600	620221 620223 620222 620227	092	

间距 Pitch [mm]	额定电流 Rated current [A]	额定电压 Rated voltage [V]	订货号 Order No.	页码 Page	例图 Picture
32	600	600	620231 620233 620232 620237	092	
10	600	600	620251 620253 620252 620257	092	
57	750	750	620521 620522	092	
57	750	750	620531 620532	092	
10	600	600	620261 620262	093	
32	600	600	620411 620412	093	
32	600	600	620421 620422	093	
32	600	600	620611 620612	093	

大电流穿墙端子

Panel feed-through terminal block with high current

该系列产品采用压线框螺钉接线技术，客户可根据应用需求选择不同的接线方向，可节约大量的安装空间，并适用于各种安装位置，可连接0.5至50mm²所有类型导线。



页码/Page: 95-96

订货号规则/Order number rule



间距 Pitch [mm]	额定电流 Rated current [A]	额定电压 Rated voltage [V]	订货号 Order No.	页码 Page	例图 Picture
41	500	500	SCWH4 SCWH4S	095	
76	500	500	SCWH10 SCWH10S	095	

间距 Pitch [mm]	额定电流 Rated current [A]	额定电压 Rated voltage [V]	订货号 Order No.	页码 Page	例图 Picture
76	800	800	SCWH16 SCWH16S	095	
101	800	800	SCWH25 SCWH25S	095	

附件

Accessory

页码/Page: 97-100

插拔式端子附件 Pluggable terminal block accessory

护线板 Protection plate	097		防错插片 Coding profile	097			
护线盒 Relief housing	097						
跨接桥 Jumper	097						

MCS连接器附件 MCS connector accessory

护线板 Protection plate	098		护线盒 Relief housing	098	跨接桥 Jumper	098	拨码元件 Coding key	099
护线盒 Relief housing	098							

MCS连接器附件 MCS connector accessory

跨接桥 Jumper	098		标记字符 Marked Numbers	099				
---------------	-----	--	------------------------	-----	--	--	--	--

大电流穿墙端子附件 Panel feed-through terminal block with high current accessory

法兰板 Flange plates	099		标记牌 Marker card	099		跨接桥 Jumper	099	
----------------------	-----	--	--------------------	-----	--	---------------	-----	--

变压器专用端子附件 Transformer terminal blocks accessory

变压器固定器 Transformer End stop	100		变压器标记牌 Transformer Marker card	100	
--------------------------------	-----	--	-----------------------------------	-----	--

弹簧接线端子专用工具 Special tools for spring terminal blocks

简易连线工具 Easy connect tool	100		一字螺丝刀 Screwdriver	100	
插棒 connect bar	100				

2.5mm间距 Pitch: 2.5mm

MC-RJ2.5HXXP-0001

产品信息 Product Information		IEC	UL
IEC/UL数据 IEC/UL Data			
额定电流 Rated current	[A]	4	4
额定电压 Rated voltage	[V]	160	125
硬导线截面积 Solid	[mm ²][AWG]	0.2-0.5	28-20
柔性导线截面积 Flexible	[mm ²][AWG]	0.2-0.5	28-20
额定冲击电压 Rated impulse voltage	[KV]	2.5	-

产品信息 Product Information		锁线螺钉 Locking crew	固定螺钉 Fixed screw	附件 Accessory
锁线螺钉 Locking crew	[N-m]	-	-	
固定螺钉 Fixed screw	[N-m]	-	-	
剥线长度 Strip length	[mm]	7-8		

订货号/通道数 Order No./Poles No.	附件 Accessory
MC-RJ2.5HXXP-0001	2-24

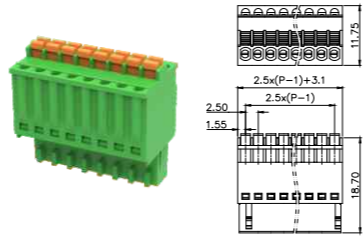

3.5mm间距 Pitch: 3.5mm

产品信息 Product Information		IEC	UL
IEC/UL数据 IEC/UL Data			
额定电流 Rated current	[A]	8	8
额定电压 Rated voltage	[V]	160	300
硬导线截面积 Solid	[mm ²][AWG]	0.2-1.5	24-16
柔性导线截面积 Flexible	[mm ²][AWG]	0.2-1.5	24-16
额定冲击电压 Rated impulse voltage	[KV]	2.5	-

产品信息 Product Information		锁线螺钉 Locking crew	固定螺钉 Fixed screw	附件 Accessory
锁线螺钉 Locking crew	[N-m]	M2	-	
固定螺钉 Fixed screw	[N-m]	M2.5	-	
剥线长度 Strip length	[mm]	7-8		

订货号/通道数 Order No./Poles No.	附件 Accessory
MC-RA3.5HXXC-0001	2-24
MC-RA3.5HXXC-K-0001	2-24
MC-RA3.5HXXC-I-0001	2-24

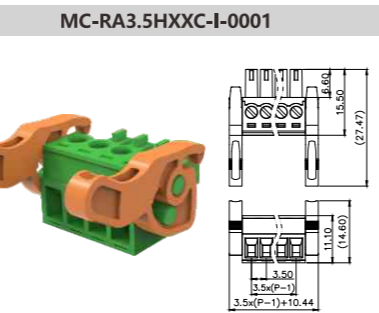
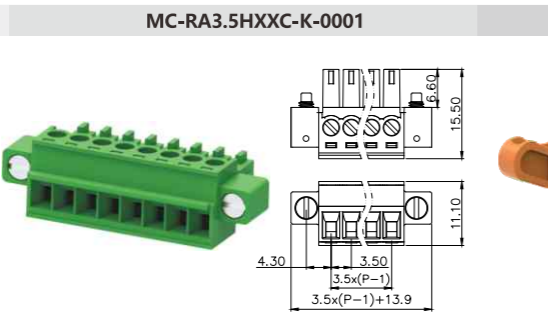
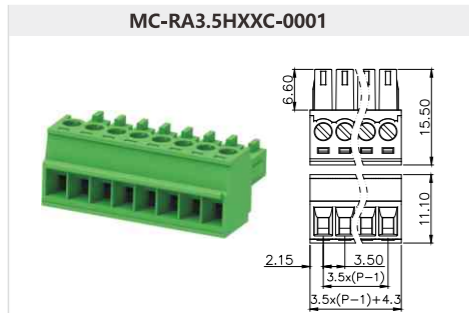

3.5mm间距 Pitch: 3.5mm

产品信息 Product Information		IEC	UL
IEC/UL数据 IEC/UL Data			
额定电流 Rated current	[A]	8	8
额定电压 Rated voltage	[V]	160	300
硬导线截面积 Solid	[mm ²][AWG]	0.2-1.5	24-16
柔性导线截面积 Flexible	[mm ²][AWG]	0.2-1.5	24-16
额定冲击电压 Rated impulse voltage	[KV]	2.5	-

产品信息 Product Information		锁线螺钉 Locking crew	固定螺钉 Fixed screw	附件 Accessory
锁线螺钉 Locking crew	[N-m]	M2	-	
固定螺钉 Fixed screw	[N-m]	M2.5	-	
剥线长度 Strip length	[mm]	7-8		

订货号/通道数 Order No./Poles No.	附件 Accessory
MC-RE3.5VXXC-0001	2-24
MC-RE3.5VXXC-K-0001	2-24
MC-RE3.5VXXC-I-0001	2-24
MC-RE3.5VXXC-R-0001	2-24
MC-RE3.5VXXC-RK-0001	2-24

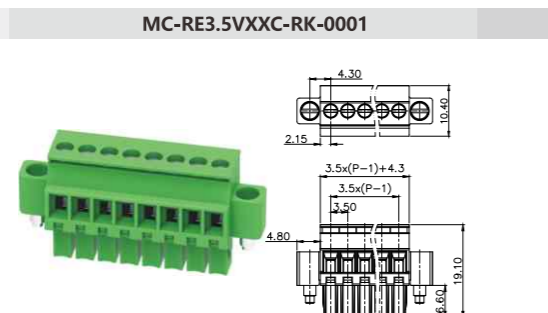
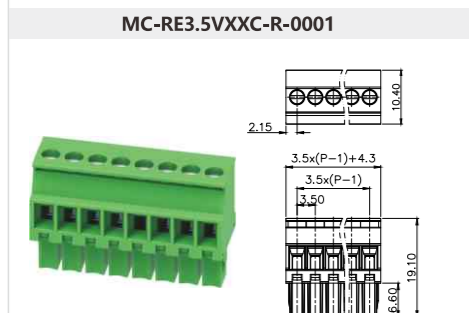
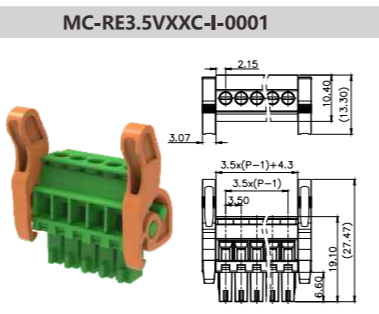
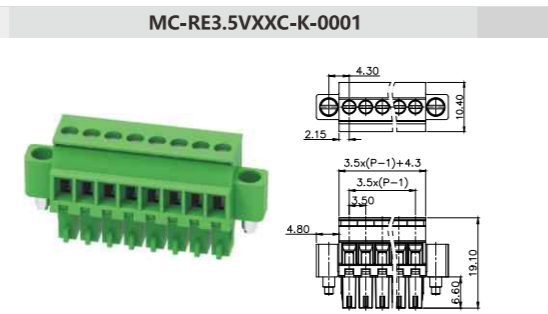
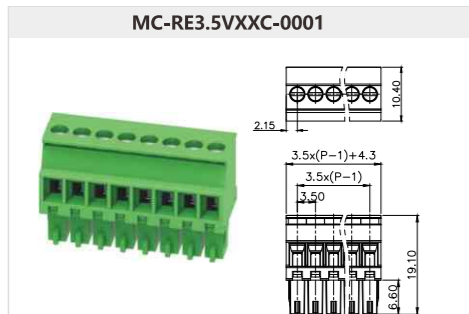

2.5mm间距 Pitch: 2.5mm

产品信息 Product Information		IEC	UL
IEC/UL数据 IEC/UL Data			
额定电流 Rated current	[A]	4	4
额定电压 Rated voltage	[V]	160	125
硬导线截面积 Solid	[mm ²][AWG]	-	-
柔性导线截面积 Flexible	[mm ²][AWG]	-	-
额定冲击电压 Rated impulse voltage	[KV]	2.5	-

产品信息 Product Information		锁线螺钉 Locking crew	固定螺钉 Fixed screw	附件 Accessory
锁线螺钉 Locking crew	[N-m]	-	-	
固定螺钉 Fixed screw	[N-m]	-	-	
剥线长度 Strip length	[mm]	7-8		

订货号/通道数 Order No./Poles No.	附件 Accessory
MC-PA2.5HXX-0002	2-24
MC-PA2.5VXX-0002	2-24
MC-DPA2.5VXX-0002	4-48
MC-DPA2.5HXX-0002	4-48

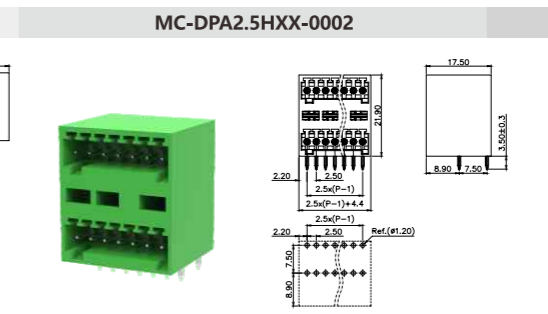
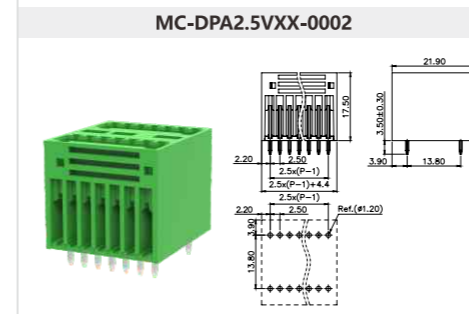
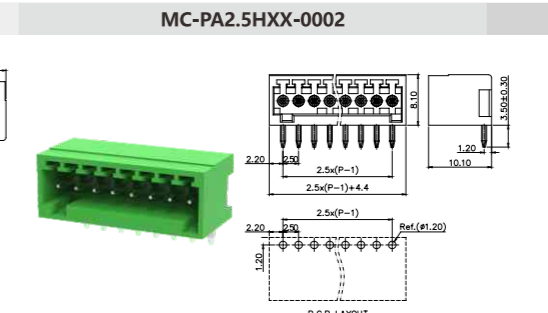
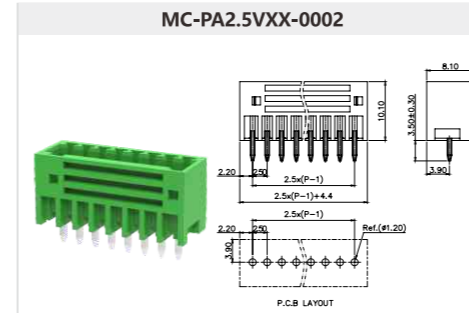

3.5mm间距 Pitch: 3.5mm

产品信息 Product Information		IEC	UL
IEC/UL数据 IEC/UL Data			
额定电流 Rated current	[A]	8	8
额定电压 Rated voltage	[V]	160	300
硬导线截面积 Solid	[mm ²][AWG]	0.2-1.5	24-16
柔性导线截面积 Flexible	[mm ²][AWG]	0.2-1.5	24-16
额定冲击电压 Rated impulse voltage	[KV]	2.5	-

产品信息 Product Information		锁线螺钉 Locking crew	固定螺钉 Fixed screw	附件 Accessory
锁线螺钉 Locking crew	[N-m]	-	-	
固定螺钉 Fixed screw	[N-m]	M2.5	-	
剥线长度 Strip length	[mm]	8-9		

订货号/通道数 Order No./Poles No.	附件 Accessory
MC-RJ3.5HXXP-0001	2-24
MC-RJ3.5HXXP-K-0001	2-24
MC-RJ3.5HXXP-I-0001	2-24

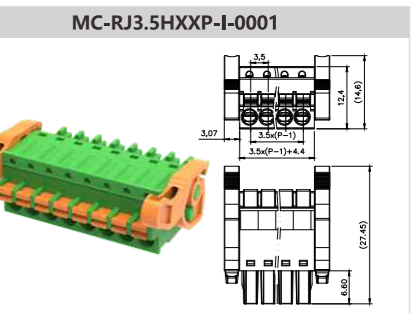
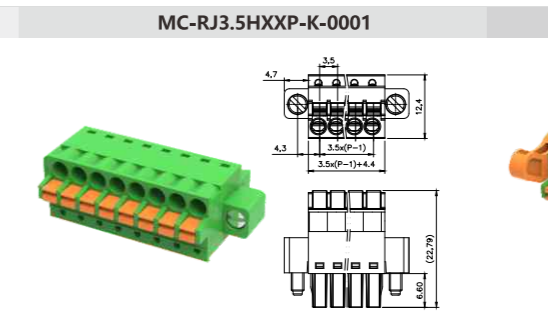
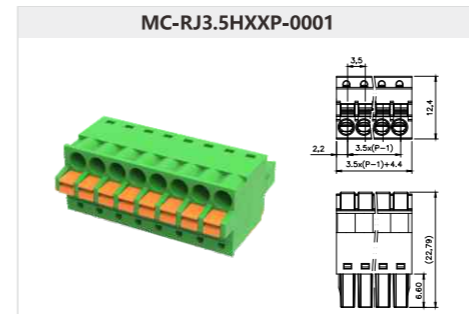

3.5mm间距 Pitch: 3.5mm

产品信息 Product Information				产品信息 Product Information				订货号/通道数 Order No./Poles No.		附件 Accessory	
IEC/UL数据 IEC/UL Data				锁线螺钉 Locking crew				MC-DRD3.5HXXP		4-20	
额定电流 Rated current	[A]	8	8	扭矩 Torque	[N·m]	-	-	MC-DRD3.5HXXP-K	4-20		
额定电压 Rated voltage	[V]	160	300	固定螺钉 Fixed screw		M2.5					
硬导线截面积 Solid	[mm ²][AWG]	0.2-1.5	24-16	扭矩 Torque	[N·m]	0.3					
柔性导线截面积 Flexible	[mm ²][AWG]	0.2-1.5	24-16	剥线长度 Strip length	[mm]	9-10					
额定冲击电压 Rated impulse voltage	[KV]	2.5	-								

MC-DRD3.5HXXP-0001

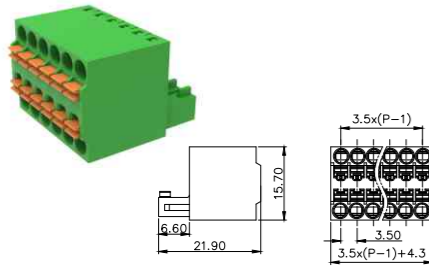

MC-DRD3.5HXXP-K-0001

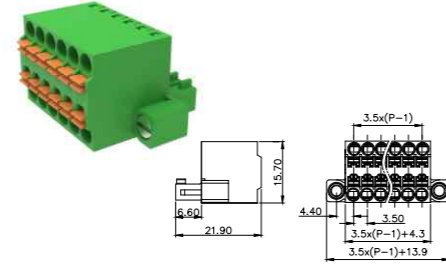

3.5mm间距 Pitch: 3.5mm

产品信息 Product Information				产品信息 Product Information				订货号/通道数 Order No./Poles No.		附件 Accessory	
IEC/UL数据 IEC/UL Data				锁线螺钉 Locking crew				MC-DRF3.5HXXP-0001		2-24	
额定电流 Rated current	[A]	8	8	扭矩 Torque	[N·m]	-	-	MC-DRF3.5HXXP-D-0001	2-24		
额定电压 Rated voltage	[V]	160	300	固定螺钉 Fixed screw		-	-	MC-DRF3.5HXXP-K-0001	2-24		
硬导线截面积 Solid	[mm ²][AWG]	0.2-1.5	24-16	扭矩 Torque	[N·m]	-	-				
柔性导线截面积 Flexible	[mm ²][AWG]	0.2-1.5	24-16	剥线长度 Strip length	[mm]	10					
额定冲击电压 Rated impulse voltage	[KV]	2.5	-								

MC-DRF3.5HXXP-0001

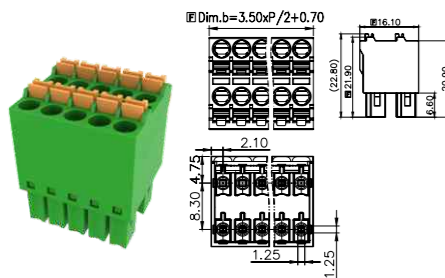

MC-DRF3.5HXXP-D-0001

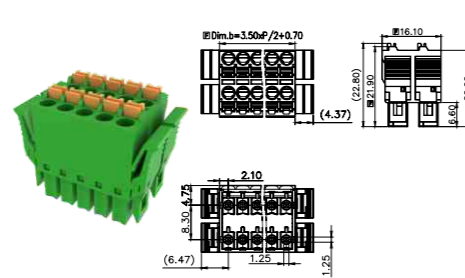

MC-DRF3.5HXXP-K-0001

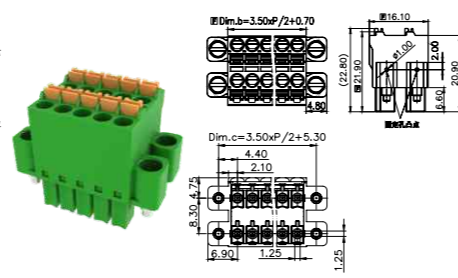

3.5mm间距 Pitch: 3.5mm

产品信息 Product Information				产品信息 Product Information				订货号/通道数 Order No./Poles No.		附件 Accessory	
IEC/UL数据 IEC/UL Data				锁线螺钉 Locking crew				MC-RF3.5HXXP-0001		2-24	
额定电流 Rated current	[A]	8	8	扭矩 Torque	[N·m]	-	-	MC-RF3.5HXXP-K-0001	2-24		
额定电压 Rated voltage	[V]	160	150	固定螺钉 Fixed screw		M2.5		MC-RF3.5HXXP-I-0001	2-24		
硬导线截面积 Solid	[mm ²][AWG]	0.2-1.5	24-16	扭矩 Torque	[N·m]	0.3		MC-RF3.5HXXP-D-0001	2-24		
柔性导线截面积 Flexible	[mm ²][AWG]	0.2-1.5	24-16	剥线长度 Strip length	[mm]	10					
额定冲击电压 Rated impulse voltage	[KV]	2.5	-								

MC-RF3.5HXXP-0001

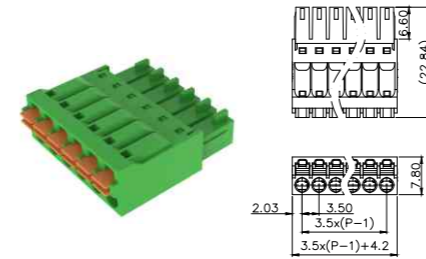

MC-RF3.5HXXP-K-0001

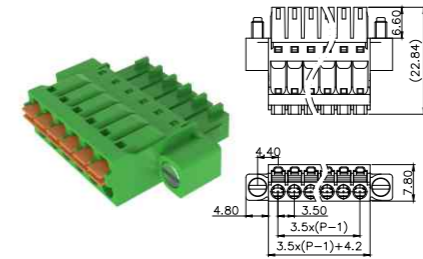

MC-RF3.5HXXP-I-0001

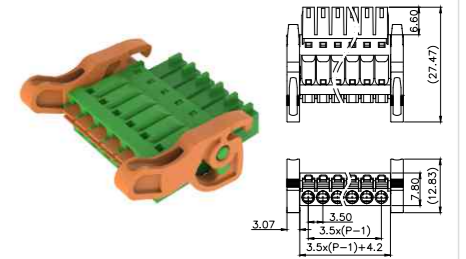

MC-RF3.5HXXP-D-0001

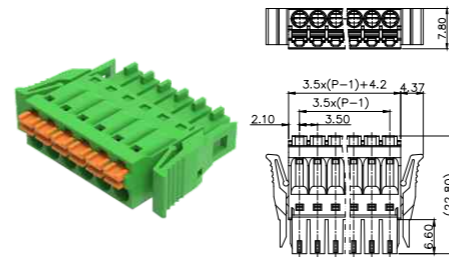

3.5mm间距 Pitch: 3.5mm

产品信息 Product Information				产品信息 Product Information				订货号/通道数 Order No./Poles No.		附件 Accessory	
IEC/UL数据 IEC/UL Data				锁线螺钉 Locking crew				MC-DPAN3.5VXX-BK-2600		4-48	
额定电流 Rated current	[A]	8	8	扭矩 Torque	[N·m]	-	-	MC-DPAN3.5VXX-D-BK-2600	4-48		
额定电压 Rated voltage	[V]	160	150	固定螺钉 Fixed screw		M2.5		MC-DPAN3.5VXX-F-BK-2600	4-48		
硬导线截面积 Solid	[mm ²][AWG]	-	-	扭矩 Torque	[N·m]	0.3		MC-DPAN3.5HXX-BK-2600	4-48		
柔性导线截面积 Flexible	[mm ²][AWG]	-	-	剥线长度 Strip length	[mm]	-		MC-DPAN3.5HXX-D-BK-2600	4-48		
额定冲击电压 Rated impulse voltage	[KV]	2.5	-					MC-DPAN3.5HXX-F-BK-2600	4-48		

MC-DPAN3.5VXX-BK-2600

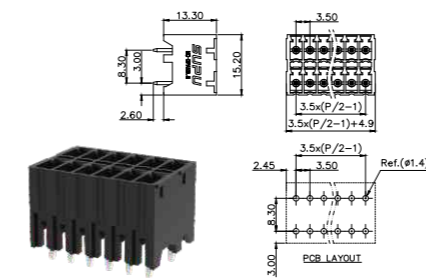

MC-DPAN3.5VXX-D-BK-2600

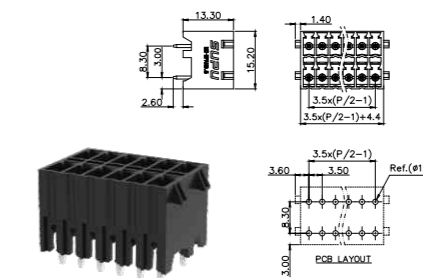

MC-DPAN3.5VXX-F-BK-2600

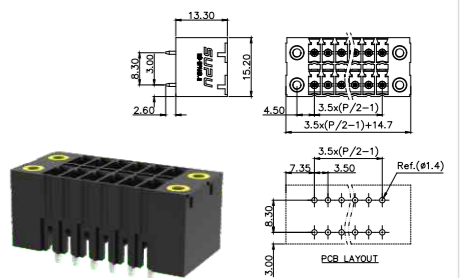

MC-DPAN3.5HXX-BK-2600

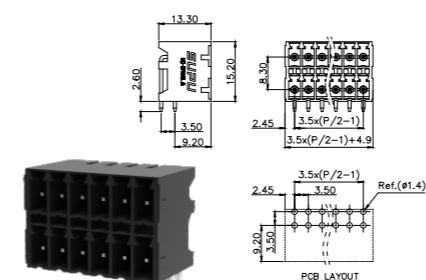

MC-DPAN3.5HXX-D-BK-2600

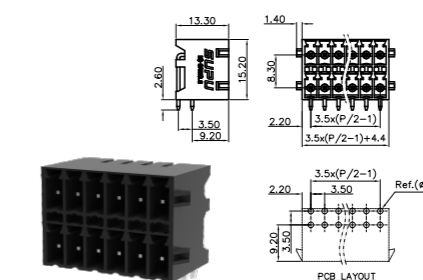

MC-DPAN3.5HXX-F-BK-2600

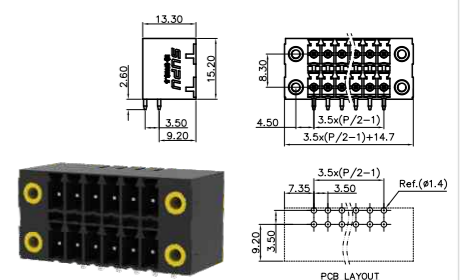

3.5mm间距 Pitch: 3.5mm

产品信息 Product Information			
IEC/UL数据 IEC/UL Data	IEC	UL	
额定电流 Rated current	[A]	8	8
额定电压 Rated voltage	[V]	160	150
硬导线截面积 Solid	[mm ²][AWG]	0.2-1.5	24-16
柔性导线截面积 Flexible	[mm ²][AWG]	0.2-1.5	24-16
额定冲击电压 Rated impulse voltage	[KV]	2.5	-

产品信息 Product Information			
锁线螺钉 Locking crew	扭矩 Torque	固定螺钉 Fixed screw	扭矩 Torque
-	[N·m]	M2.5	[N·m]
MC-PF3.5HXXP-0001	-	MC-PF3.5HXXP-D-0001	0.3
MC-PF3.5HXXP-B-0001	-	MC-PF3.5HXXP-F-0001	-
MC-PF3.5HXXP-I-0001	-	MC-PF3.5HXXP-K-0001	-

订货号/通道数 Order No./Poles No.	
MC-PF3.5HXXP-0001	2-24
MC-PF3.5HXXP-B-0001	2-24
MC-PF3.5HXXP-D-0001	2-24
MC-PF3.5HXXP-F-0001	2-24
MC-PF3.5HXXP-I-0001	2-24
MC-PF3.5HXXP-K-0001	2-24

订货号/通道数 Order /Poles No.	
MC-PF3.5HXXP-FB-0001	2-24
MC-PF3.5HXXP-IB-0001	2-24
MC-PF3.5HXXP-KB-0001	2-24

附件 Accessory

3.5mm间距 Pitch: 3.5mm

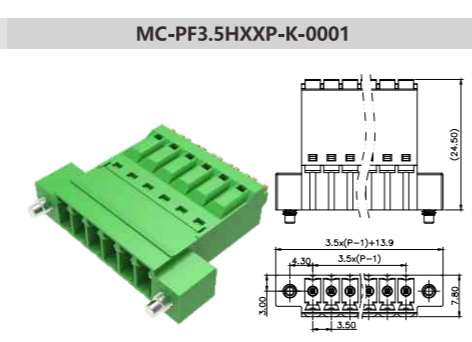
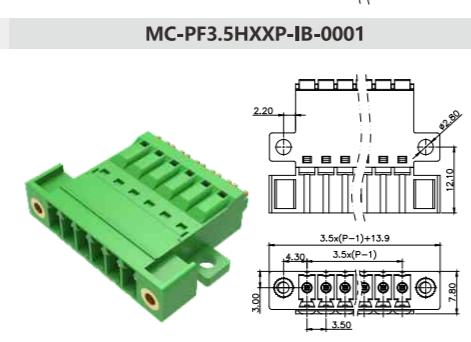
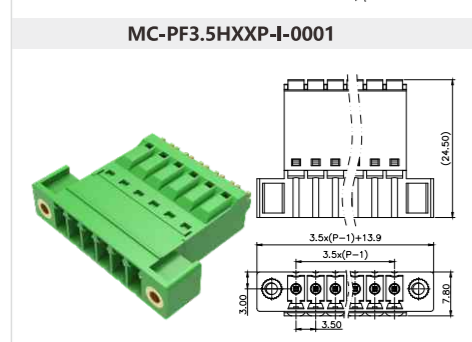
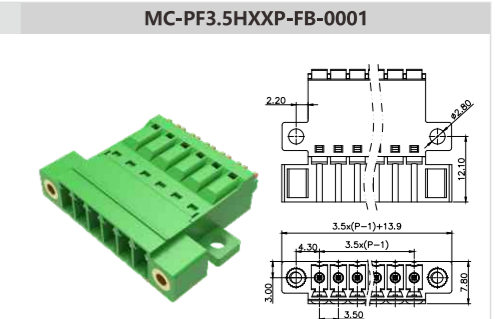
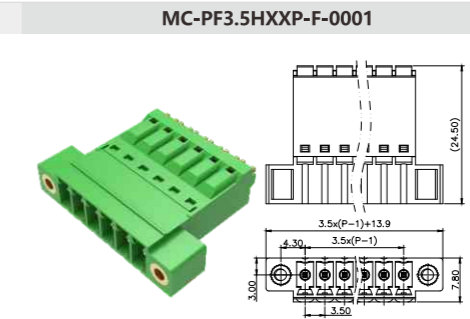
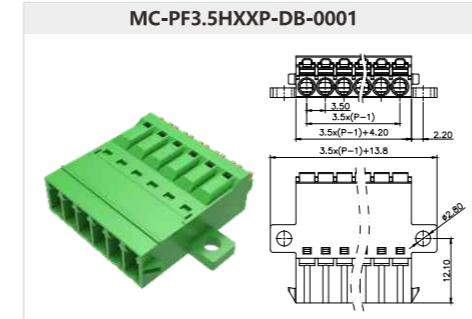
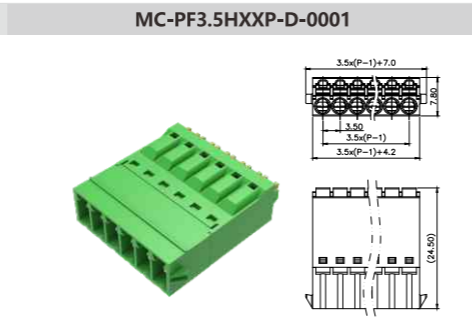
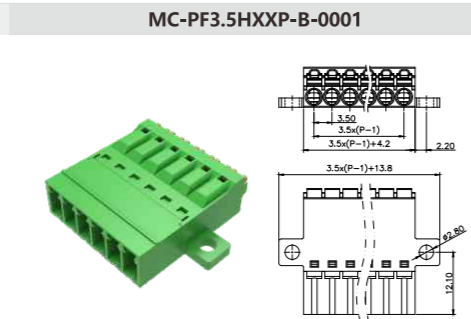
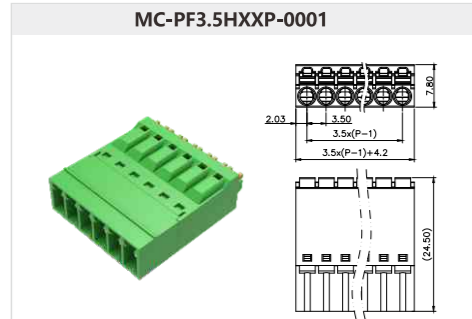

3.5mm间距 Pitch: 3.5mm

产品信息 Product Information			
IEC/UL数据 IEC/UL Data	IEC	UL	
额定电流 Rated current	[A]	8	8
额定电压 Rated voltage	[V]	160	300
硬导线截面积 Solid	[mm ²][AWG]	-	-
柔性导线截面积 Flexible	[mm ²][AWG]	-	-
额定冲击电压 Rated impulse voltage	[KV]	2.5	-

产品信息 Product Information			
锁线螺钉 Locking crew	扭矩 Torque	固定螺钉 Fixed screw	扭矩 Torque
-	[N·m]	M2.5	[N·m]
MC-PA3.5VXX-0002	-	MC-PA3.5VXX-D-0002	0.3
MC-PA3.5VXX-F-0002	-	MC-PA3.5VXX-I-0002	-
MC-PA3.5VXX-L-0002	-	MC-PA3.5VXX-L-0002	-

订货号/通道数 Order No./Poles No.	
MC-PA3.5VXX-0002	2-24
MC-PA3.5VXX-D-0002	2-24
MC-PA3.5VXX-F-0002	2-24
MC-PA3.5VXX-I-0002	2-24
MC-PA3.5VXX-L-0002	2-24

订货号/通道数 Order /Poles No.	
MC-PA3.5HXX-0002	2-24
MC-PA3.5HXX-D-0002	2-24
MC-PA3.5HXX-F-0002	2-24
MC-PA3.5HXX-I-0002	2-24
MC-PA3.5HXX-L-0002	2-24

附件 Accessory

3.5mm间距 Pitch: 3.5mm

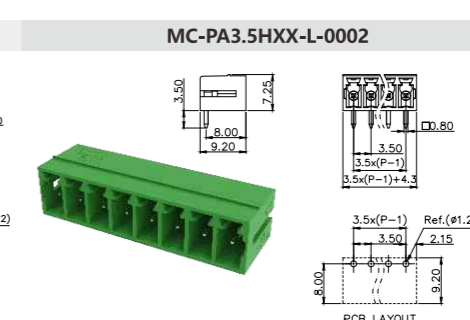
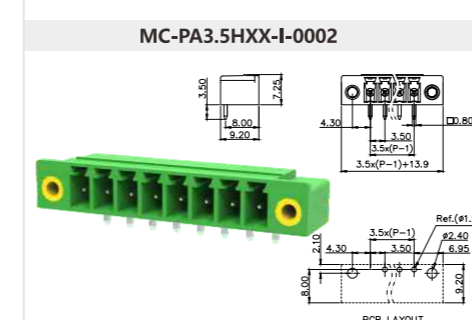
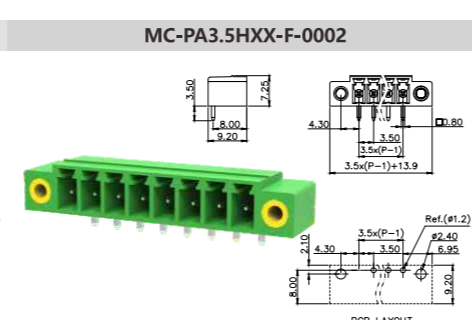
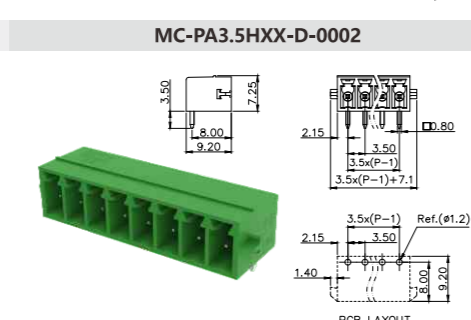
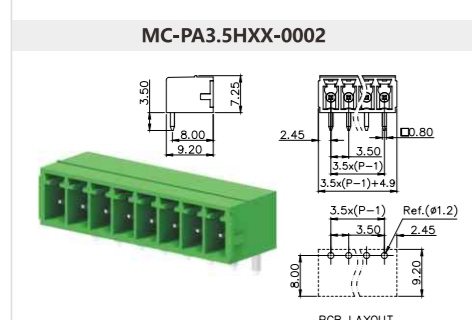
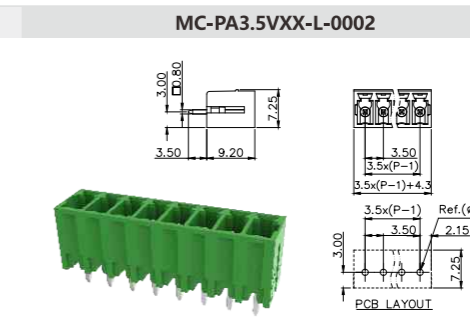
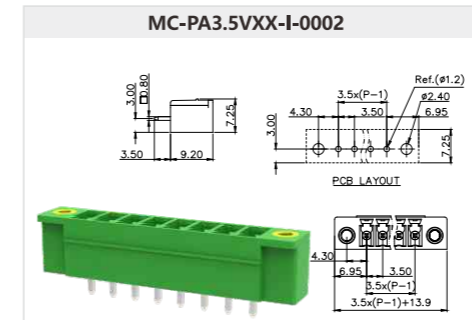
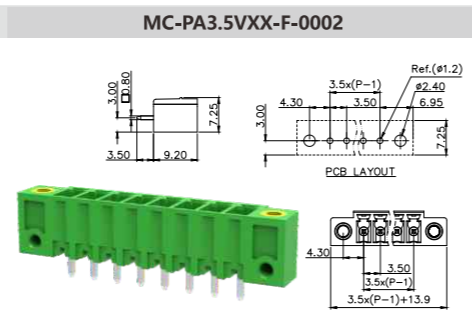
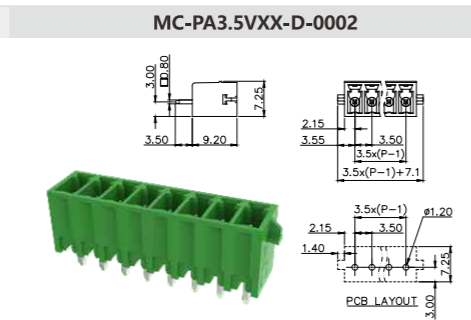
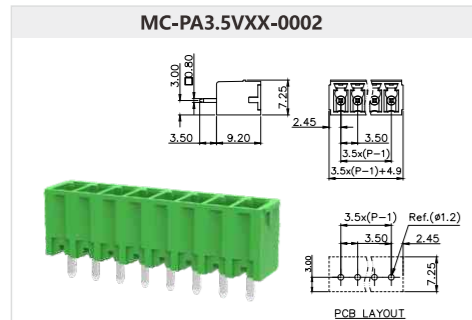

3.5mm间距 Pitch: 3.5mm

产品信息 Product Information				产品信息 Product Information				订货号/通道数 Order No./Poles No.		附件 Accessory	
IEC/UL数据 IEC/UL Data		IEC	UL	锁线螺钉 Locking crew	-	MC-DRT3.5HXXP-A-0001	4-40				
额定电流 Rated current	[A]	8	8	扭矩 Torque	[N·m]	MC-DRT3.5HXXP-K-0001	4-40				
额定电压 Rated voltage	[V]	160	150	固定螺钉 Fixed screw	M2	MC-DRT3.5HXXP-I-0001	4-40				
硬导线截面积 Solid	[mm ²][AWG]	0.2-1.5	24-16	扭矩 Torque	[N·m]						
柔性导线截面积 Flexible	[mm ²][AWG]	0.2-1.5	24-16	剥线长度 Strip length	[mm]						
额定冲击电压 Rated impulse voltage	[KV]	2.5	-								

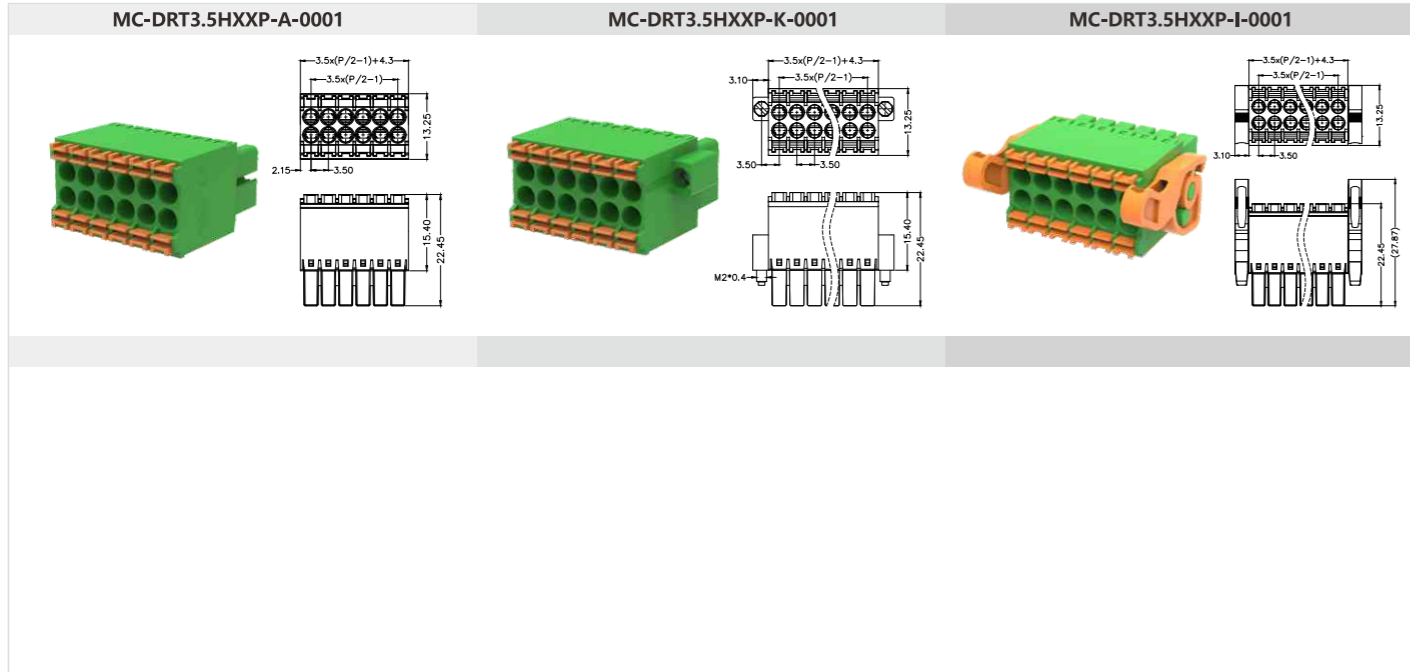

3.5mm间距 Pitch: 3.5mm

产品信息 Product Information				产品信息 Product Information				订货号/通道数 Order No./Poles No.		附件 Accessory	
IEC/UL数据 IEC/UL Data		IEC	UL	锁线螺钉 Locking crew	-	MC-DRG3.5HXXP-0001	4-48				
额定电流 Rated current	[A]	13.5	10	扭矩 Torque	[N·m]	MC-DRG3.5HXXP-K-0001	4-48				
额定电压 Rated voltage	[V]	160	300	固定螺钉 Fixed screw	M2	MC-DRG3.5HXXP-I-0001	4-48				
硬导线截面积 Solid	[mm ²][AWG]	0.2-1.5	24-16	扭矩 Torque	[N·m]						
柔性导线截面积 Flexible	[mm ²][AWG]	0.2-1.5	24-16	剥线长度 Strip length	[mm]						
额定冲击电压 Rated impulse voltage	[KV]	2.5	-								

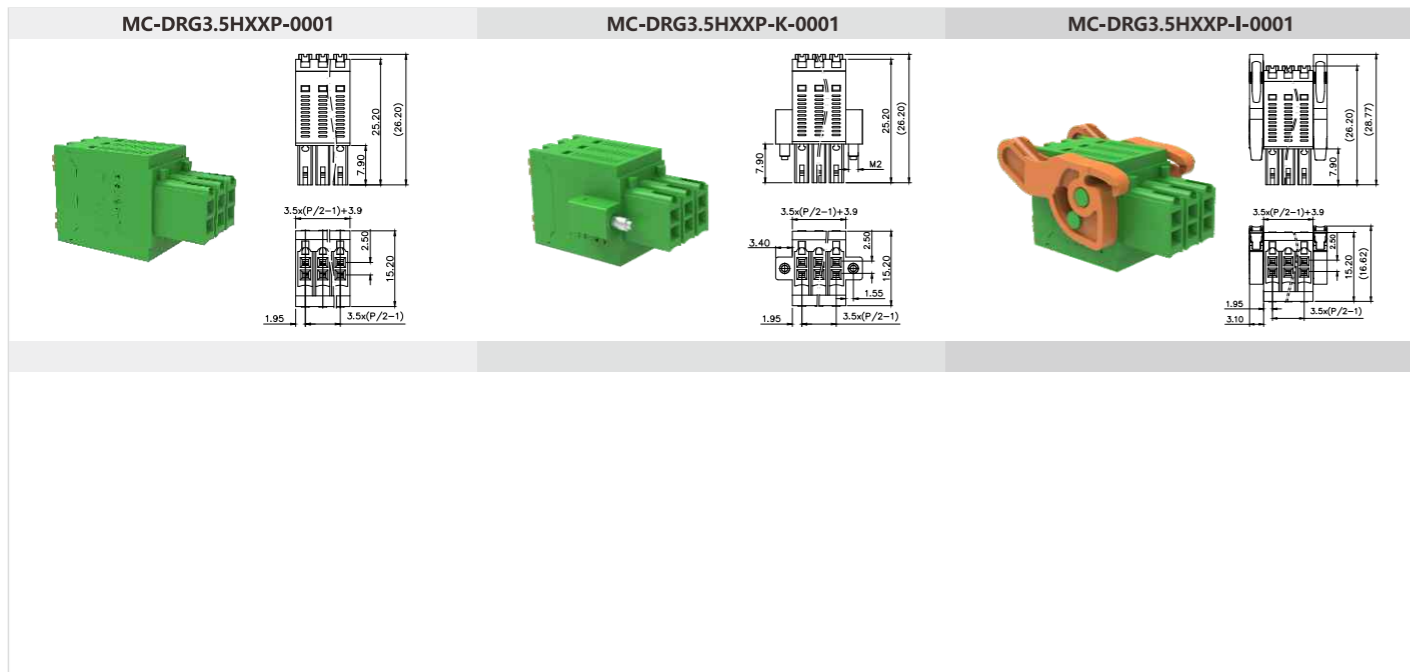

3.5mm间距 Pitch: 3.5mm

产品信息 Product Information				产品信息 Product Information				订货号/通道数 Order No./Poles No.		附件 Accessory	
IEC/UL数据 IEC/UL Data		IEC	UL	锁线螺钉 Locking crew	-	MC-DPT3.5VXX-BK-2000	4-40				
额定电流 Rated current	[A]	8	8	扭矩 Torque	[N·m]	MC-DPT3.5VXX-F-BK-2000	4-40				
额定电压 Rated voltage	[V]	160	150	固定螺钉 Fixed screw	M2.0	MC-DPT3.5VXX-I-BK-2000	4-40				
硬导线截面积 Solid	[mm ²][AWG]	-	-	扭矩 Torque	[N·m]	MC-DPT3.5HXX-BK-2000	4-40				
柔性导线截面积 Flexible	[mm ²][AWG]	-	-	剥线长度 Strip length	[mm]	MC-DPT3.5HXX-F-BK-2000	4-40				
额定冲击电压 Rated impulse voltage	[KV]	2.5	-			MC-DPT3.5HXX-I-BK-2000	4-40				

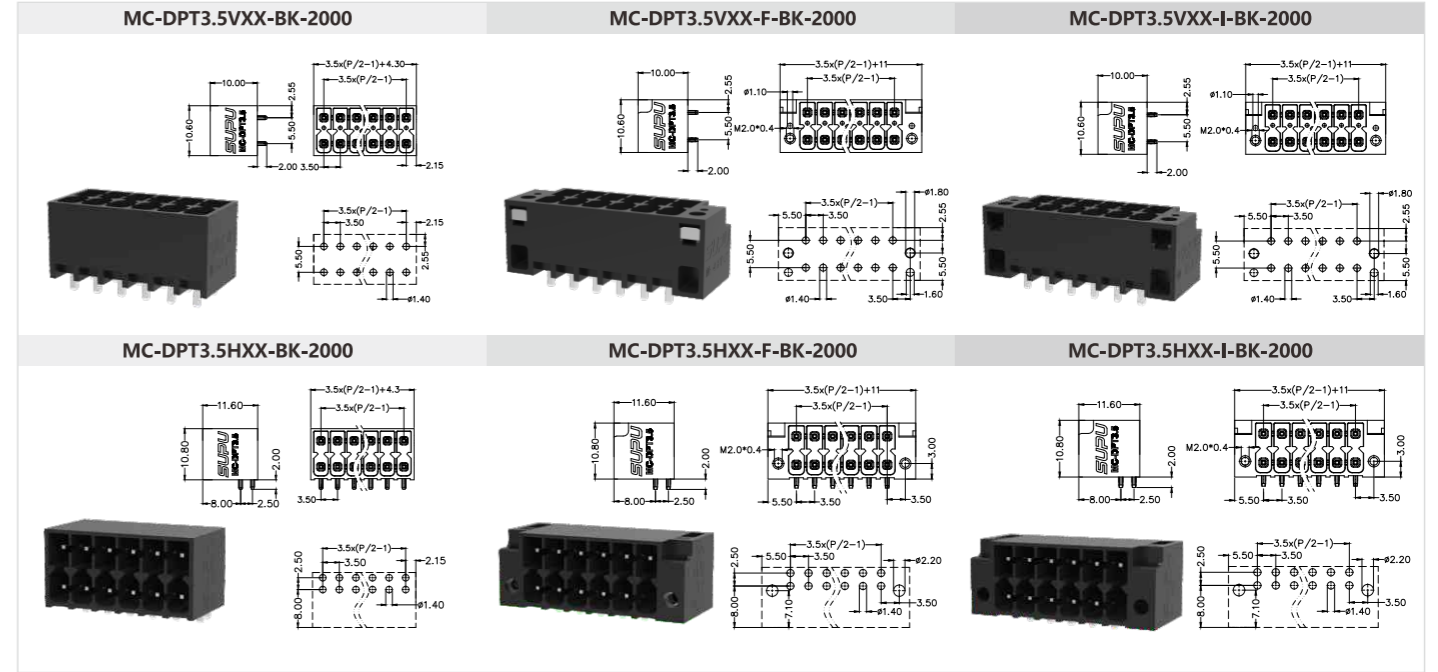

3.5mm间距 Pitch: 3.5mm

产品信息 Product Information				产品信息 Product Information				订货号/通道数 Order No./Poles No.		附件 Accessory	
IEC/UL数据 IEC/UL Data		IEC	UL	锁线螺钉 Locking crew	-	MC-DPG3.5VXX-3500	4-48				
额定电流 Rated current	[A]	10	10	扭矩 Torque	[N·m]	MC-DPG3.5VXX-F-3500	4-48				
额定电压 Rated voltage	[V]	125	150	固定螺钉 Fixed screw	M2.0	MC-DPG3.5VXX-I-3500	4-48				
硬导线截面积 Solid	[mm ²][AWG]	-	-	扭矩 Torque	[N·m]	MC-DPG3.5HXX-3500	4-48				
柔性导线截面积 Flexible	[mm ²][AWG]	-	-	剥线长度 Strip length	[mm]	MC-DPG3.5HXX-F-3500	4-48				
额定冲击电压 Rated impulse voltage	[KV]	2.5	-			MC-DPG3.5HXX-I-3500	4-48				

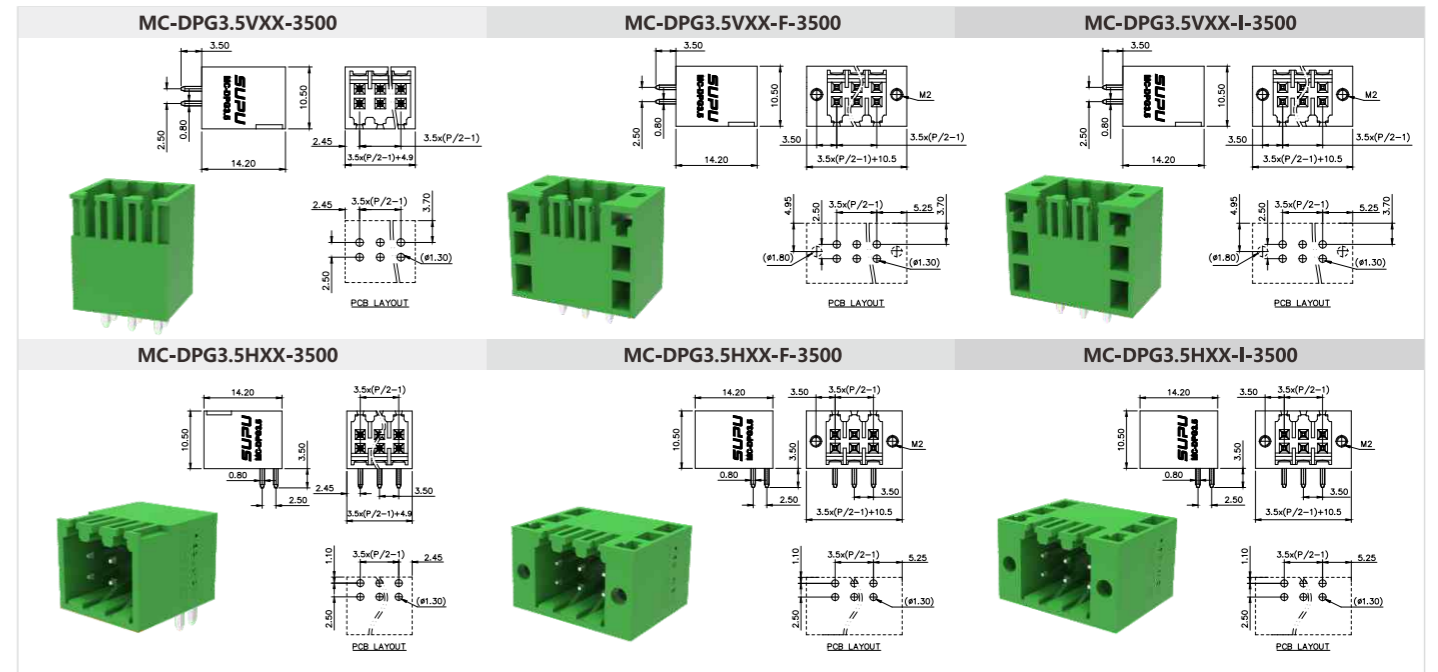

3.81mm间距 Pitch: 3.81mm

产品信息Product Information				锁线螺钉 Locking crew		订货号/通道数 Order No./Poles No.		附件Accessory	
IEC/UL数据 IEC/UL Data	IEC	UL		M2	MC-RA3.81HXXC-0001	2-24	MC-JP3.81-X		
额定电流 Rated current	[A]	8	8	扭矩 Torque [N·m]	0.2	MC-RA3.81HXXC-K-0001	2-24		
额定电压 Rated voltage	[V]	160	300	固定螺钉 Fixed screw	M2.5	MC-RA3.81HXXC-I-0001	2-24		
硬导线截面积 Solid [mm ²][AWG]		0.2-1.5	24-16	扭矩 Torque [N·m]	0.3				
柔性导线截面积 Flexible [mm ²][AWG]		0.2-1.5	24-16	剥线长度 Strip length [mm]	6-7				
额定冲击电压 Rated impulse voltage	[KV]	2.5	-						

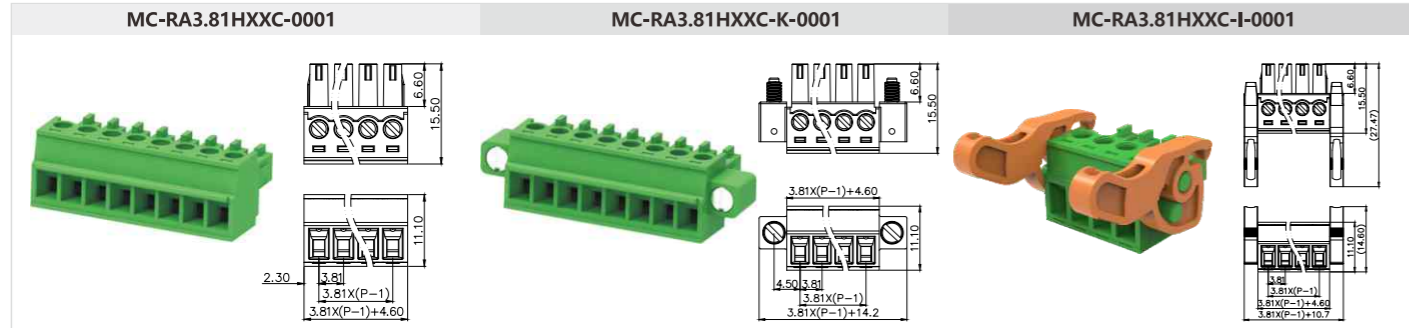

3.81mm间距 Pitch: 3.81mm

产品信息Product Information				锁线螺钉 Locking crew		订货号/通道数 Order No./Poles No.		附件Accessory	
IEC/UL数据 IEC/UL Data	IEC	UL		M2	MC-RAF3.81HXXC-0001	2-24	MC-JP3.81-X		
额定电流 Rated current	[A]	8	8	扭矩 Torque [N·m]	0.2	MC-RAF3.81HXXC-K-0001	2-24		
额定电压 Rated voltage	[V]	160	300	固定螺钉 Fixed screw	M2.5	MC-RAF3.81HXXC-I-0001	2-24		
硬导线截面积 Solid [mm ²][AWG]		0.2-1.5	24-16	扭矩 Torque [N·m]	0.3				
柔性导线截面积 Flexible [mm ²][AWG]		0.2-1.5	24-16	剥线长度 Strip length [mm]	8-9				
额定冲击电压 Rated impulse voltage	[KV]	2.5	-						

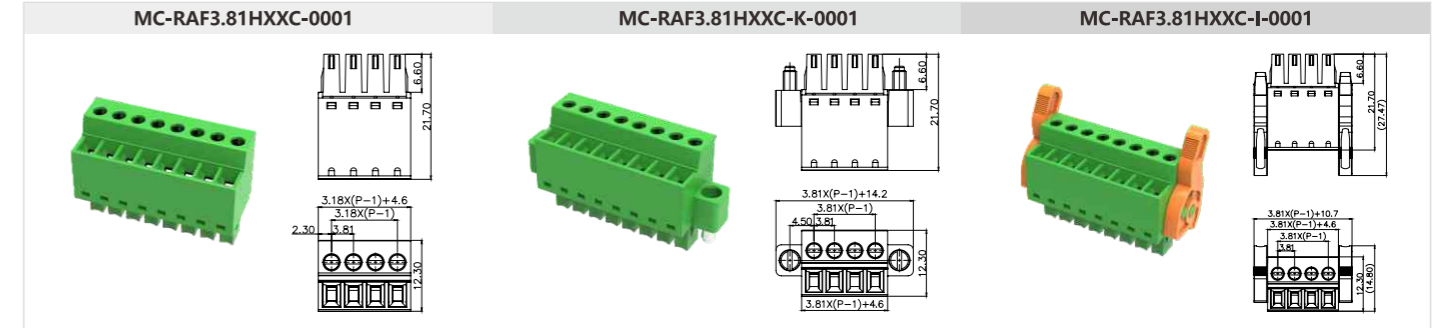

3.81mm间距 Pitch: 3.81mm

产品信息Product Information				锁线螺钉 Locking crew		订货号/通道数 Order No./Poles No.		附件Accessory	
IEC/UL数据 IEC/UL Data	IEC	UL		M2	MC-RE3.81VXXC-0001	2-24	MC-JP3.81-X		
额定电流 Rated current	[A]	8	8	扭矩 Torque [N·m]	0.2	MC-RE3.81VXXC-K-0001	2-24		
额定电压 Rated voltage	[V]	160	300	固定螺钉 Fixed screw	M2.5	MC-RE3.81VXXC-I-0001	2-24		
硬导线截面积 Solid [mm ²][AWG]		0.2-1.5	24-16	扭矩 Torque [N·m]	0.3	MC-RE3.81VXXC-R-0001	2-24		
柔性导线截面积 Flexible [mm ²][AWG]		0.2-1.5	24-16	剥线长度 Strip length [mm]	7-8	MC-RE3.81VXXC-RK-0001	2-24		
额定冲击电压 Rated impulse voltage	[KV]	2.5	-						

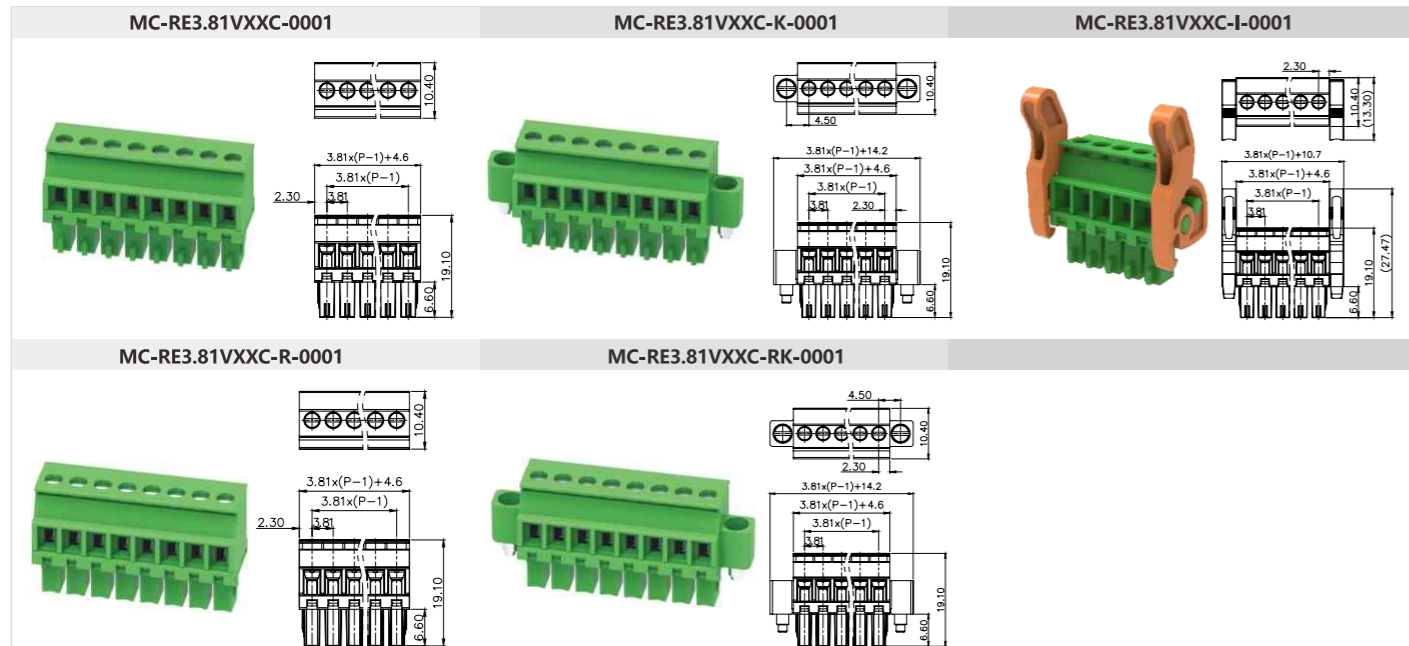

3.81mm间距 Pitch: 3.81mm

产品信息Product Information				锁线螺钉 Locking crew		订货号/通道数 Order No./Poles No.		附件Accessory	
IEC/UL数据 IEC/UL Data	IEC	UL		-	MC-RJ3.81HXXP-0001	2-24	MC-JP3.81-X		
额定电流 Rated current	[A]	8	8	扭矩 Torque [N·m]	-	MC-RJ3.81HXXP-K-0001	2-24		
额定电压 Rated voltage	[V]	160	300	固定螺钉 Fixed screw	M2.5	MC-RJ3.81HXXP-I-0001	2-24		
硬导线截面积 Solid [mm ²][AWG]		0.2-1.5	24-16	扭矩 Torque [N·m]	0.3				
柔性导线截面积 Flexible [mm ²][AWG]		0.2-1.5	24-16	剥线长度 Strip length [mm]	8-9				
额定冲击电压 Rated impulse voltage	[KV]	2.5	-						

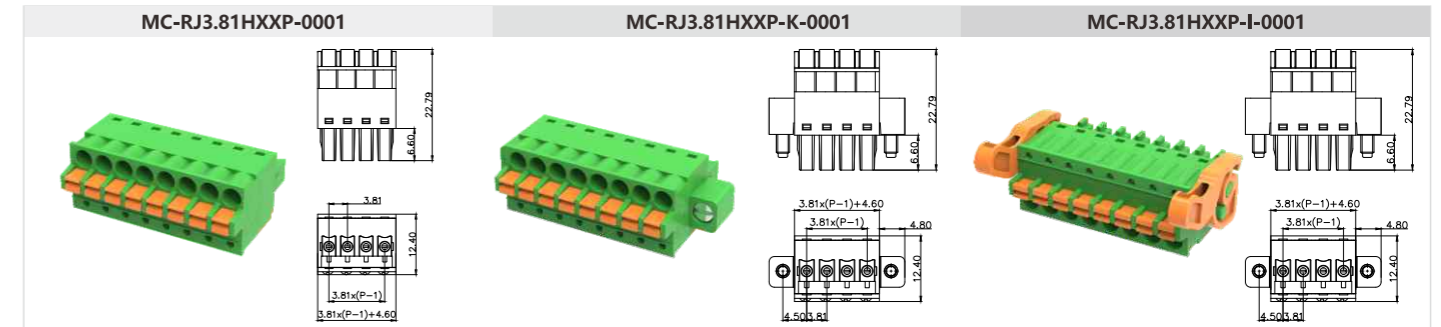

3.81mm间距 Pitch: 3.81mm

产品信息 Product Information				产品信息 Product Information				订货号/通道数 Order No./Poles No.		附件 Accessory	
IEC/UL数据 IEC/UL Data	IEC	UL		锁线螺钉 Locking crew	-	MC-RF3.81HXXP-0001	2-24	MC-JP3.81-X			
额定电流 Rated current	[A]	8	8	扭矩 Torque	[N·m]	MC-RF3.81HXXP-K-0001	2-24				
额定电压 Rated voltage	[V]	160	150	固定螺钉 Fixed screw	M2.5	MC-RF3.81HXXP-I-0001	2-24				
硬导线截面积 Solid	[mm ²][AWG]	0.2-1.5	24-16	扭矩 Torque	[N·m]	MC-RF3.81HXXP-D-0001	2-24				
柔性导线截面积 Flexible	[mm ²][AWG]	0.2-1.5	24-16	剥线长度 Strip length	[mm]						
额定冲击电压 Rated impulse voltage	[KV]	2.5	-								

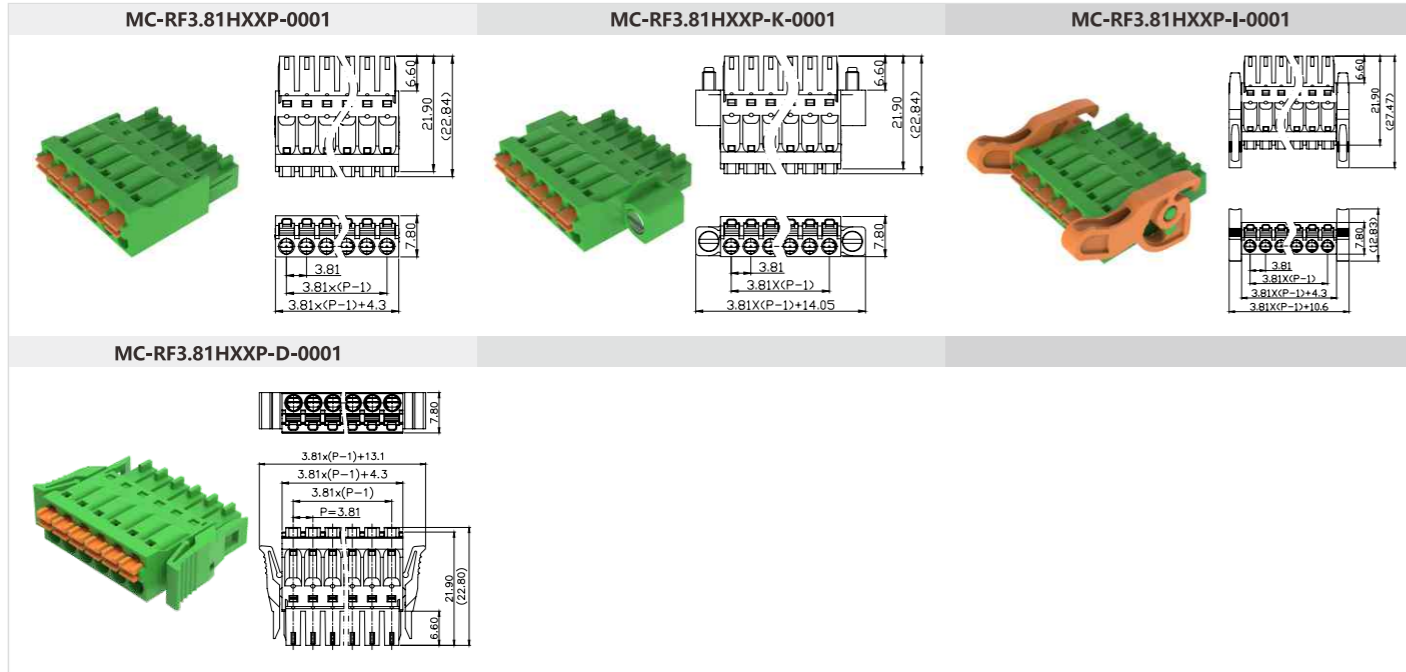

3.81mm间距 Pitch: 3.81mm

产品信息 Product Information				产品信息 Product Information				订货号/通道数 Order No./Poles No.		附件 Accessory	
IEC/UL数据 IEC/UL Data	IEC	UL		锁线螺钉 Locking crew	M2.5	MC-DRF3.81HXXP-0001	4-48				
额定电流 Rated current	[A]	8	8	扭矩 Torque	[N·m]	MC-DRF3.81HXXP-D-0001	4-48				
额定电压 Rated voltage	[V]	160	300	固定螺钉 Fixed screw	-	MC-DRF3.81HXXP-K-0001	4-48				
硬导线截面积 Solid	[mm ²][AWG]	0.2-1.5	24-16	扭矩 Torque	[N·m]						
柔性导线截面积 Flexible	[mm ²][AWG]	0.2-1.5	24-16	剥线长度 Strip length	[mm]						
额定冲击电压 Rated impulse voltage	[KV]	2.5	-								

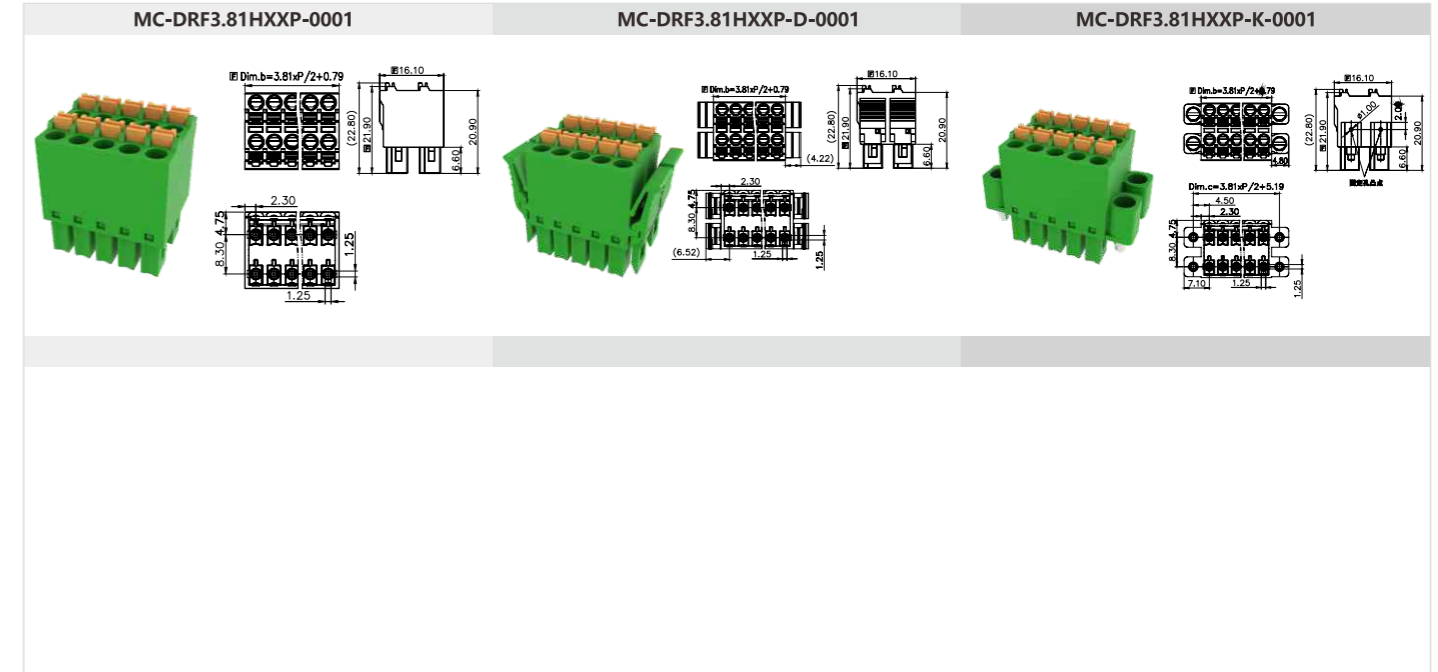

3.81mm间距 Pitch: 3.81mm

产品信息 Product Information				产品信息 Product Information				订货号/通道数 Order No./Poles No.		附件 Accessory	
IEC/UL数据 IEC/UL Data	IEC	UL		锁线螺钉 Locking crew	-	MC-DPAN3.81VXX-BK-2600	4-48	MC-R-MSTB3.81			
额定电流 Rated current	[A]	8	8	扭矩 Torque	[N·m]	MC-DPAN3.81VXX-D-BK-2600	4-48				
额定电压 Rated voltage	[V]	160	150	固定螺钉 Fixed screw	M2.5	MC-DPAN3.81VXX-F-BK-2600	4-48				
硬导线截面积 Solid	[mm ²][AWG]	-	-	扭矩 Torque	[N·m]	MC-DPAN3.81HXX-BK-2600	4-48				
柔性导线截面积 Flexible	[mm ²][AWG]	-	-	剥线长度 Strip length	[mm]	MC-DPAN3.81HXX-D-BK-2600	4-48				
额定冲击电压 Rated impulse voltage	[KV]	2.5	-			MC-DPAN3.81HXX-F-BK-2600	4-48				

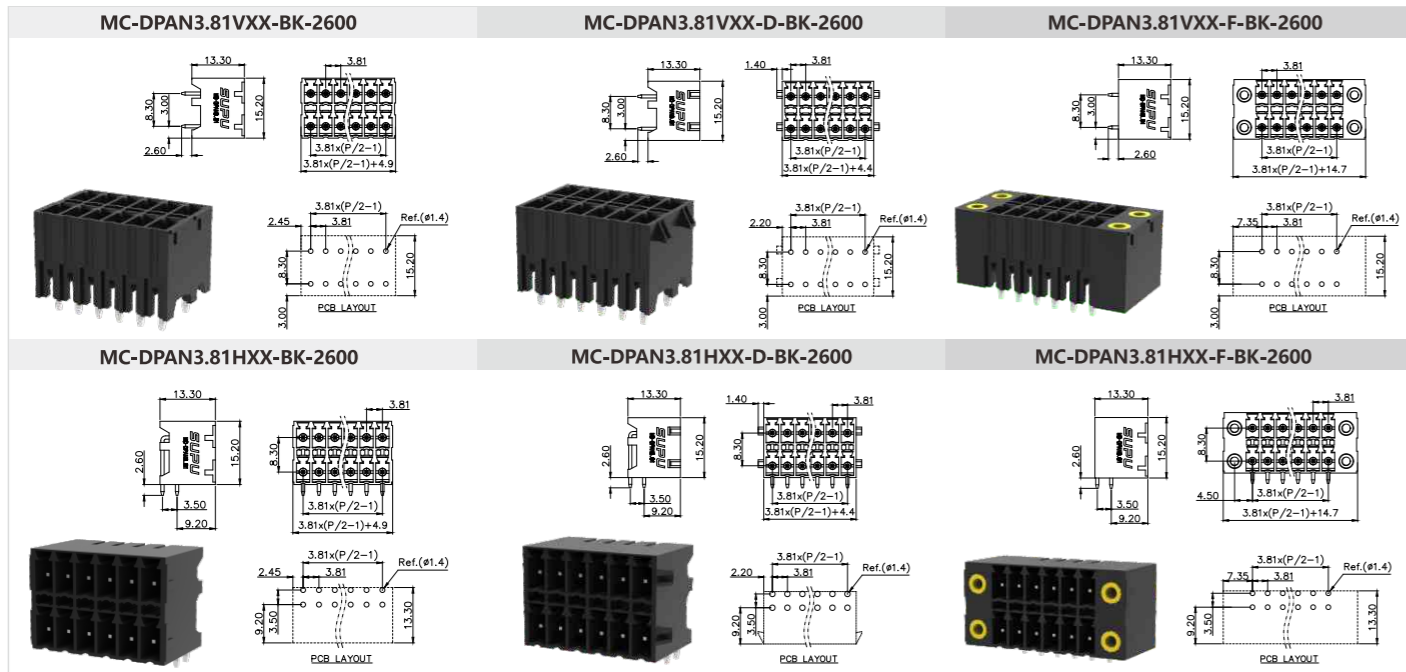

3.81mm间距 Pitch: 3.81mm

产品信息 Product Information				产品信息 Product Information				订货号/通道数 Order No./Poles No.		附件 Accessory	
IEC/UL数据 IEC/UL Data	IEC	UL		锁线螺钉 Locking crew	-	MC-RU3.81SHXX-0001	2-24				
额定电流 Rated current	[A]	8	8	扭矩 Torque	[N·m]	MC-RU3.81SHXX-F-0001	2-24				
额定电压 Rated voltage	[V]	160	300	固定螺钉 Fixed screw	M2.5	MC-RU3.81SVXX-0001	2-24				
硬导线截面积 Solid	[mm ²][AWG]	0.2-1.5	-	扭矩 Torque	[N·m]	MC-RU3.81SVXX-F-0001	2-24				
柔性导线截面积 Flexible	[mm ²][AWG]	0.2-1.5	-	剥线长度 Strip length	[mm]						
额定冲击电压 Rated impulse voltage	[KV]	2.5	-								

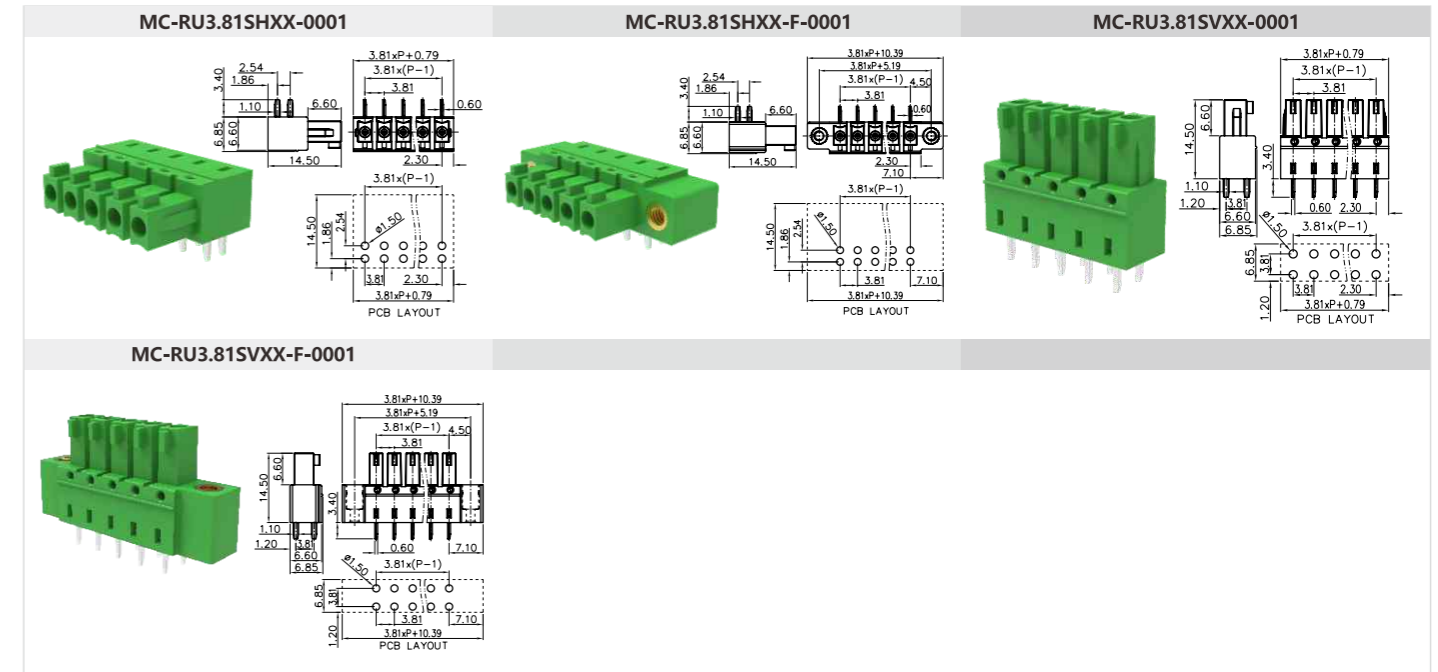

3.81mm间距 Pitch: 3.81mm

产品信息 Product Information			
IEC/UL数据 IEC/UL Data	IEC	UL	
额定电流 Rated current	[A]	8	8
额定电压 Rated voltage	[V]	160	150
硬导线截面积 Solid	[mm ²][AWG]	0.2-1.5	24-16
柔性导线截面积 Flexible	[mm ²][AWG]	0.2-1.5	24-16
额定冲击电压 Rated impulse voltage	[KV]	2.5	-

产品信息 Product Information			
锁线螺钉 Locking crew	扭矩 Torque	固定螺钉 Fixed screw	扭矩 Torque
-	[N·m]	M2.5	[N·m]
-	-	0.3	-
-	-	10	-

订货号/通道数 Order No./Poles No.		订货号/通道数 Order /Poles No.	
MC-PF3.81HXXP-0001	2-24	MC-PF3.81HXXP-FB-0001	2-24
MC-PF3.81HXXP-B-0001	2-24	MC-PF3.81HXXP-I-0001	2-24
MC-PF3.81HXXP-D-0001	2-24	MC-PF3.81HXXP-IB-0001	2-24
MC-PF3.81HXXP-DB-0001	2-24	MC-PF3.81HXXP-K-0001	2-24
MC-PF3.81HXXP-F-0001	2-24		

附件 Accessory	
MC-R-MSTB3.81	
MC-JP3.81-X	

3.81mm间距 Pitch: 3.81mm

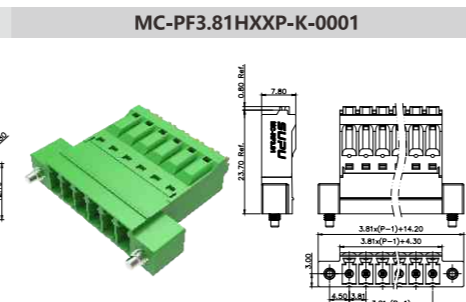
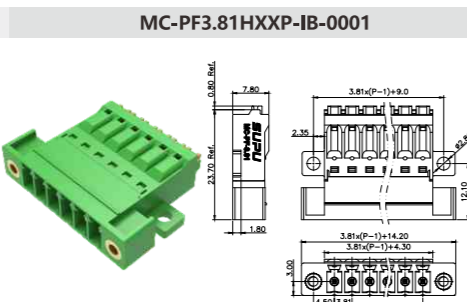
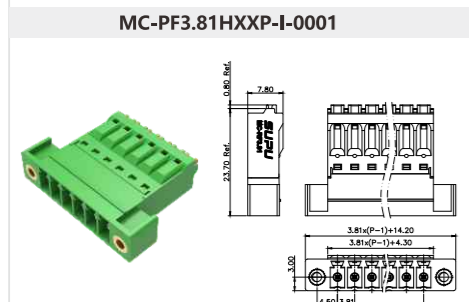
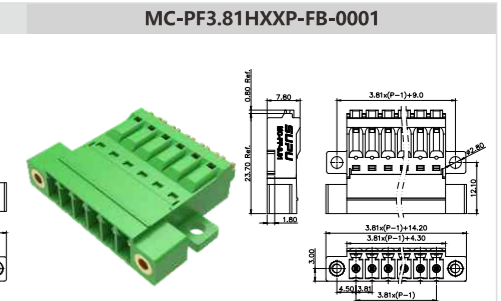
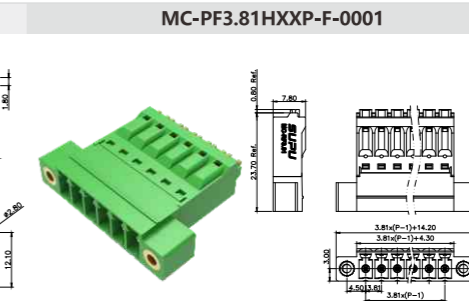
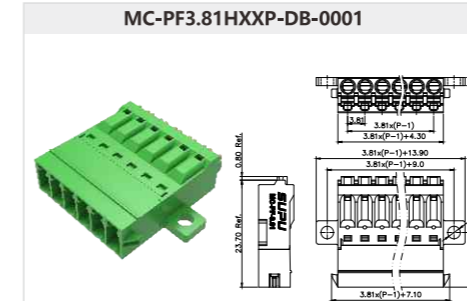
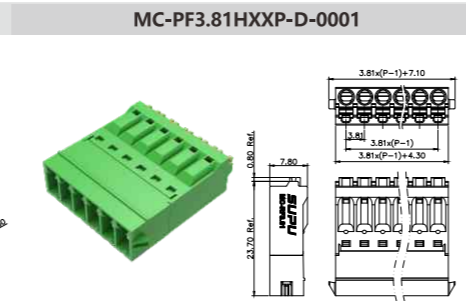
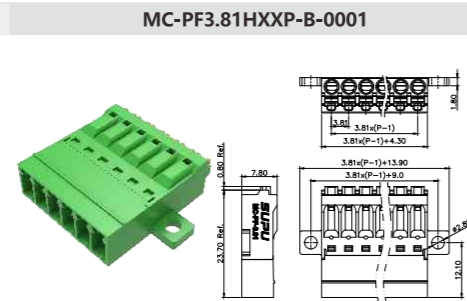
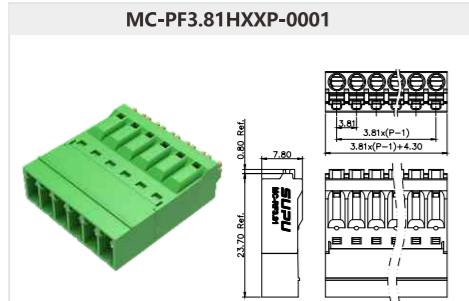

3.81mm间距 Pitch: 3.81mm

产品信息 Product Information			
IEC/UL数据 IEC/UL Data	IEC	UL	
额定电流 Rated current	[A]	8	8
额定电压 Rated voltage	[V]	160	300
硬导线截面积 Solid	[mm ²][AWG]	-	-
柔性导线截面积 Flexible	[mm ²][AWG]	-	-
额定冲击电压 Rated impulse voltage	[KV]	2.5	-

产品信息 Product Information			
锁线螺钉 Locking crew	扭矩 Torque	固定螺钉 Fixed screw	扭矩 Torque
-	[N·m]	M2.5	[N·m]
-	-	0.3	-
-	-	-	-

订货号/通道数 Order No./Poles No.		订货号/通道数 Order /Poles No.	
MC-PA3.81VXX-0002	2-24	MC-PA3.81HXX-I-0002	2-24
MC-PA3.81VXX-F-0002	2-24	MC-PA3.81HXX-L-0002	2-24
MC-PA3.81VXX-I-0002	2-24	MC-PA3.81HXX-0002	2-24
MC-PA3.81VXX-L-0002	2-24	MC-PA3.81HXX-F-0002	2-24
MC-PA3.81HXX-0002	2-24		
MC-PA3.81HXX-F-0002	2-24		

附件 Accessory	
MC-R-MSTB3.81	

3.81mm间距 Pitch: 3.81mm

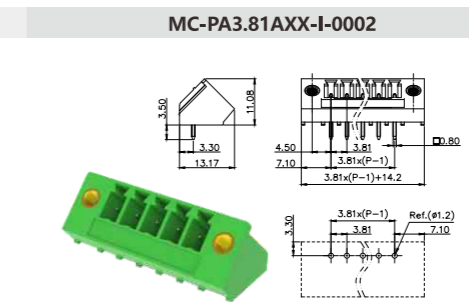
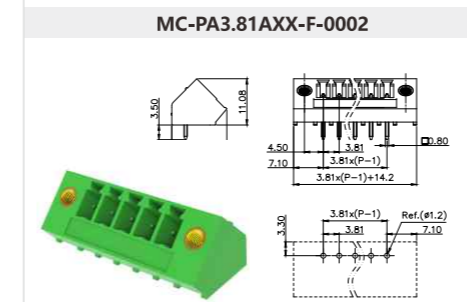
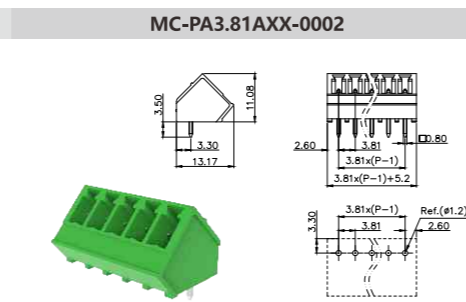
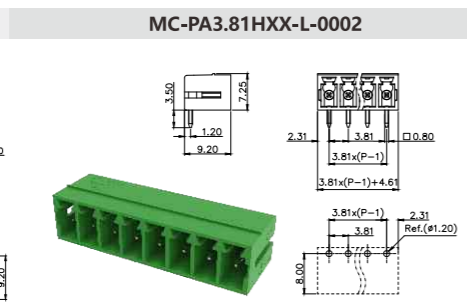
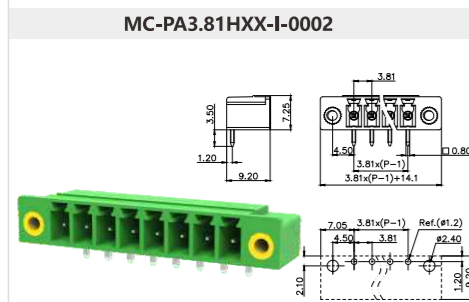
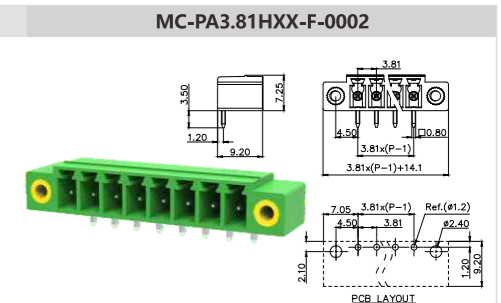
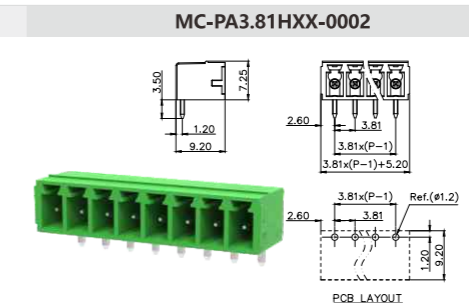
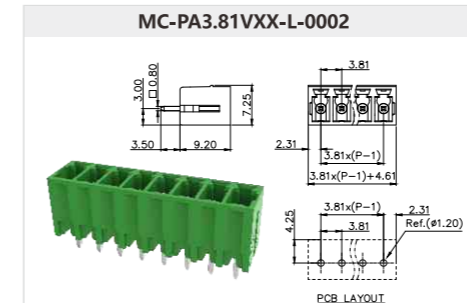
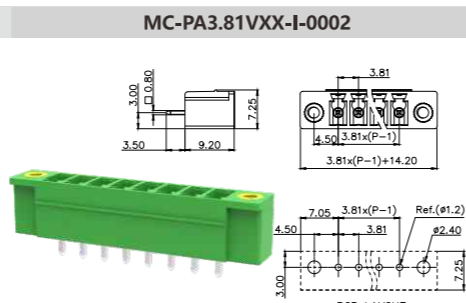
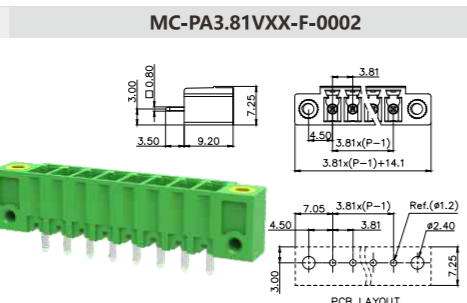
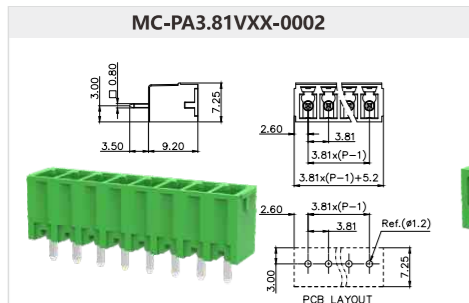

3.81mm间距 Pitch: 3.81mm

产品信息Product Information				产品信息Product Information				订货号/通道数 Order No./Poles No.		附件Accessory	
IEC/UL数据 IEC/UL Data	IEC	UL		锁线螺钉 Locking crew	-	MC-DPA3.81VXX-0002	4-48	MC-R-MSTB3.81			
额定电流 Rated current	[A]	8	8	扭矩 Torque	[N·m]	MC-DPA3.81VXX-F-0002	4-48				
额定电压 Rated voltage	[V]	160	300	固定螺钉 Fixed screw	M2.5	MC-DPA3.81HXX-0002	4-48				
硬导线截面积 Solid	[mm ²][AWG]	-	-	扭矩 Torque	[N·m]	MC-DPA3.81HXX-F-0002	4-48				
柔性导线截面积 Flexible	[mm ²][AWG]	-	-	剥线长度 Strip length	[mm]						
额定冲击电压 Rated impulse voltage	[KV]	2.5	-								

MC-DPA3.81VXX-0002

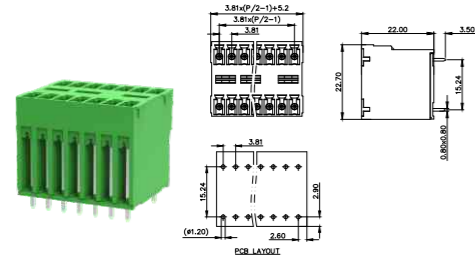

MC-DPA3.81VXX-F-0002

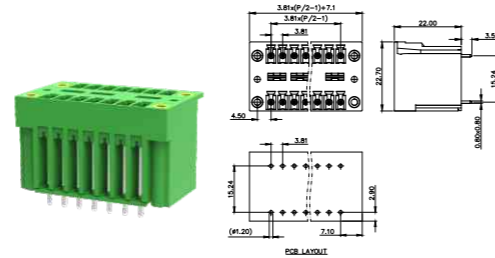

MC-DPA3.81HXX-0002

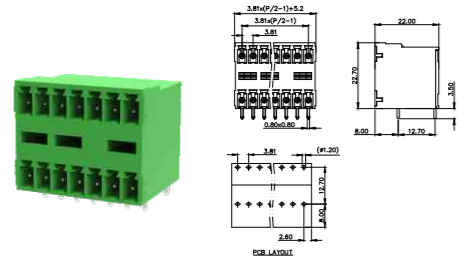

MC-DPA3.81HXX-F-0002

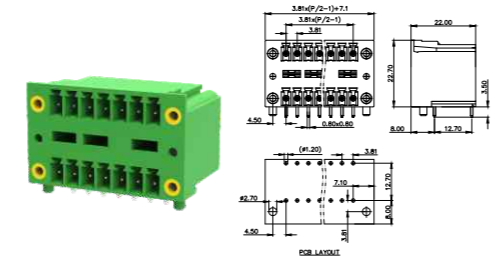

3.81mm间距 Pitch: 3.81mm

产品信息Product Information				产品信息Product Information				订货号/通道数 Order No./Poles No.		附件Accessory	
IEC/UL数据 IEC/UL Data	IEC	UL		锁线螺钉 Locking crew	-	MC-DPAB3.81VXX-0001	4-48	MC-R-MSTB3.81			
额定电流 Rated current	[A]	8	8	扭矩 Torque	[N·m]	MC-DPAB3.81VXX-F-0001	4-48				
额定电压 Rated voltage	[V]	160	300	固定螺钉 Fixed screw	M2.5	MC-DPAB3.81VXX-I-0001	4-48				
硬导线截面积 Solid	[mm ²][AWG]	-	-	扭矩 Torque	[N·m]	MC-DPAB3.81HXX-0001	4-48				
柔性导线截面积 Flexible	[mm ²][AWG]	-	-	剥线长度 Strip length	[mm]	MC-DPAB3.81HXX-F-0001	4-48				
额定冲击电压 Rated impulse voltage	[KV]	2.5	-			MC-DPAB3.81HXX-I-0001	4-48				

MC-DPAB3.81VXX-0001

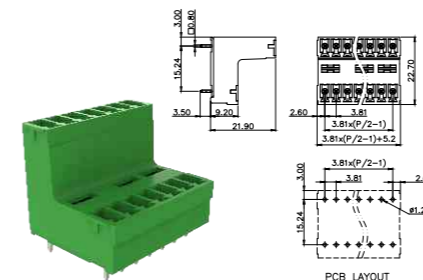

MC-DPAB3.81VXX-F-0001

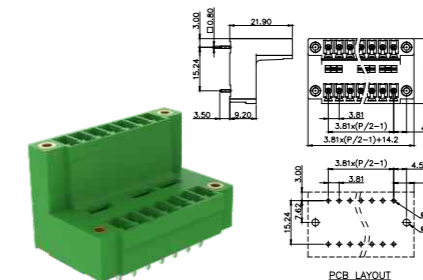

MC-DPAB3.81VXX-I-0001

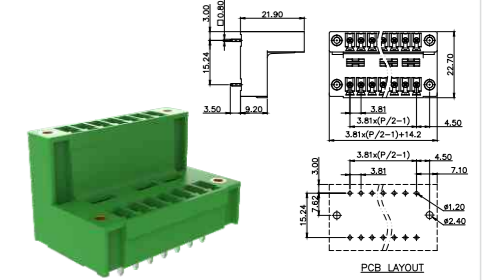

MC-DPAB3.81HXX-0001

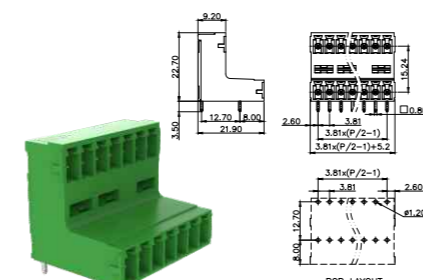

MC-DPAB3.81HXX-F-0001

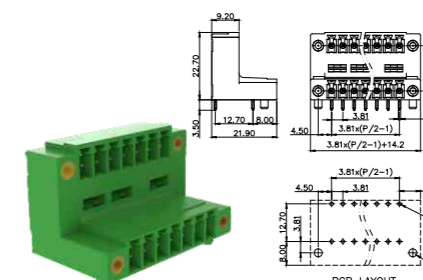

MC-DPAB3.81HXX-I-0001

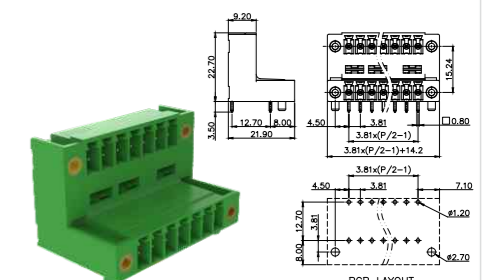

3.81mm间距 Pitch: 3.81mm

产品信息Product Information				产品信息Product Information				订货号/通道数 Order No./Poles No.		订货号/通道数 Order No./Poles No.	
IEC/UL数据 IEC/UL Data	IEC	UL		锁线螺钉 Locking crew	M2	MC-PB3.81HXXC-0001	2-24	MC-PB3.81HXXC-I-0001	2-24		
额定电流 Rated current	[A]	8	8	扭矩 Torque	[N·m]	MC-PB3.81HXXC-B-0001	2-24	MC-PB3.81HXXC-IB-0001	2-24		
额定电压 Rated voltage	[V]	160	300	固定螺钉 Fixed screw	M2.5	MC-PB3.81HXXC-F-0001	2-24	MC-PB3.81HXXC-K-0001	2-24		
硬导线截面积 Solid	[mm ²][AWG]	0.2-1.5	24-16	扭矩 Torque	[N·m]	MC-PB3.81HXXC-FB-0001	2-24	MC-PB3.81HXXC-KB-0001	2-24		
柔性导线截面积 Flexible	[mm ²][AWG]	0.2-1.5	24-16	剥线长度 Strip length	[mm]						
额定冲击电压 Rated impulse voltage	[KV]	2.5	-								

附件Accessory

MC-R-MSTB3.81	
MC-JP3.81-X	

3.81mm间距 Pitch: 3.81mm

MC-PB3.81HXXC-0001

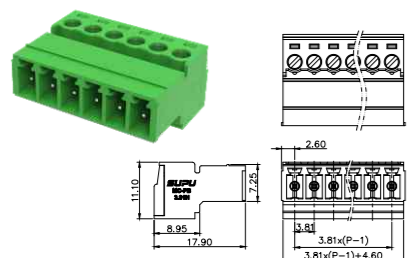

MC-PB3.81HXXC-B-0001

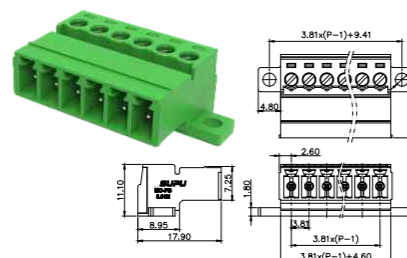

MC-PB3.81HXXC-F-0001

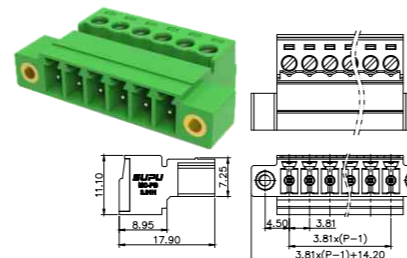

MC-PB3.81HXXC-FB-0001

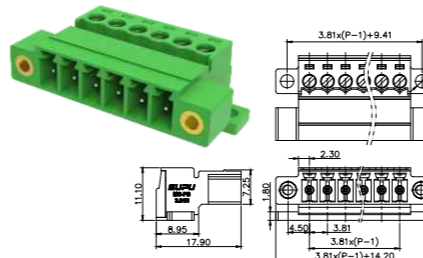

MC-PB3.81HXXC-I-0001

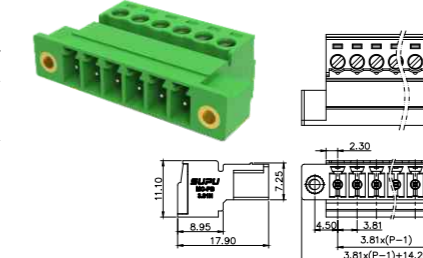

MC-PB3.81HXXC-IB-0001

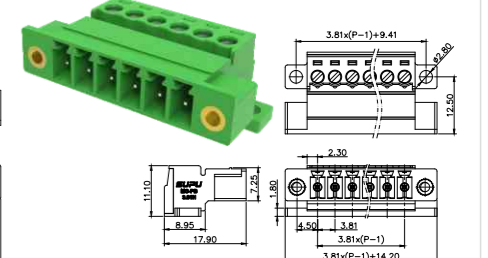

MC-PB3.81HXXC-K-0001

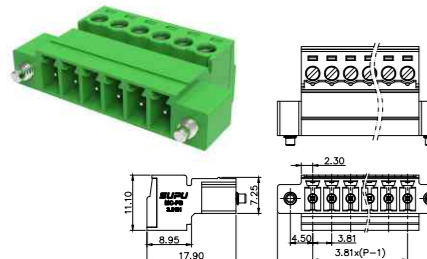

MC-PB3.81HXXC-KB-0001

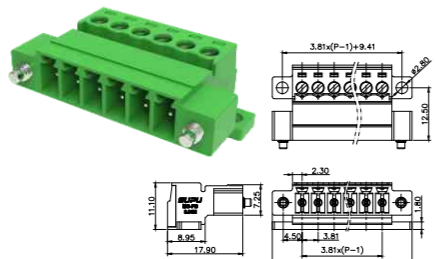

5.0mm间距 Pitch: 5.0mm

产品信息 Product Information				产品信息 Product Information		订货号/通道数 Order No./Poles No.		附件 Accessory	
IEC/UL数据 IEC/UL Data	IEC	UL		锁线螺钉 Locking crew	M3	MC-RB5.0HXXC-0001	2-24	MC-WG5.0-XX	
额定电流 Rated current	[A]	18	15	扭矩 Torque	[N·m]	MC-RB5.0HXXC-K-0001	2-24	MC-GW5.08-9.9	
额定电压 Rated voltage	[V]	320	300	固定螺钉 Fixed screw	M2.5	MC-RB5.0HXXC-I-0001	2-24	MC-GW5.08-19.9	
硬导线截面积 Solid	[mm ²][AWG]	0.2-2.5	24-12	扭矩 Torque	[N·m]			MC-GW5.08-39.9	
柔性导线截面积 Flexible	[mm ²][AWG]	0.2-2.5	24-12	剥线长度 Strip length	[mm]			MC-JP5.0-XX	
额定冲击电压 Rated impulse voltage	[KV]	4	-					MC-R-MSTB	

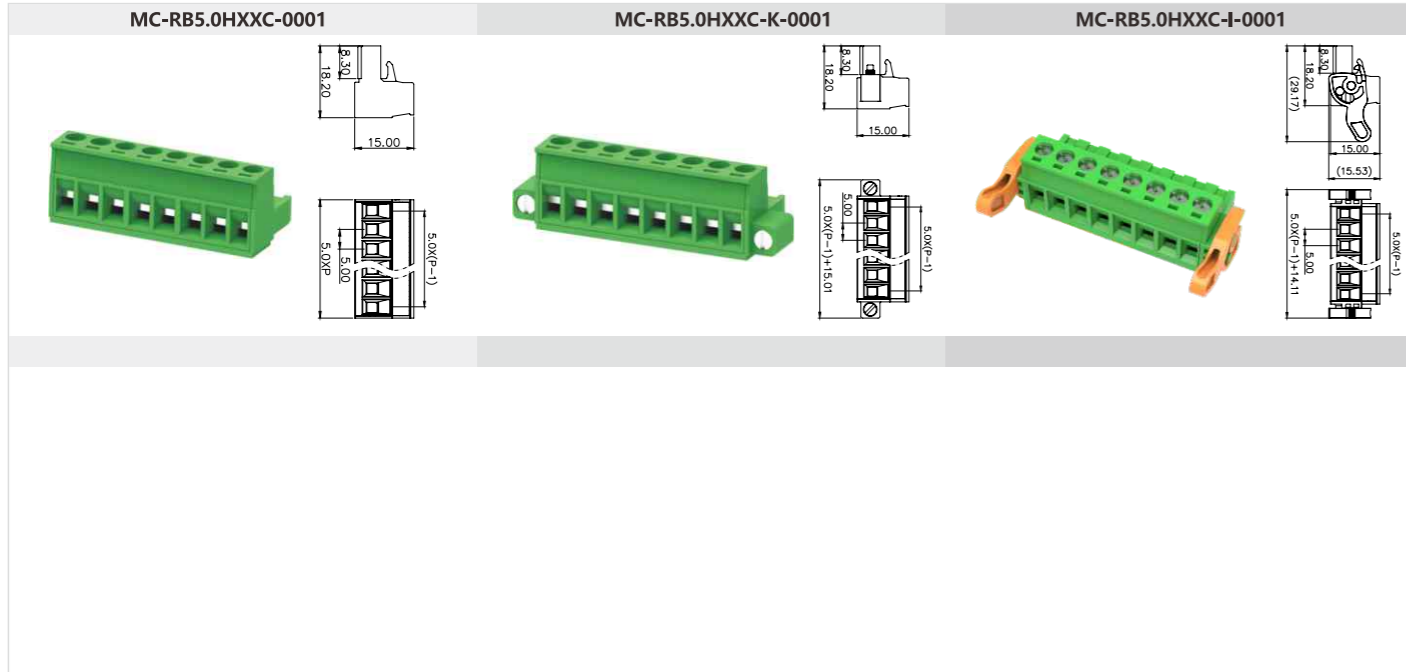

5.0mm间距 Pitch: 5.0mm

产品信息 Product Information				产品信息 Product Information		订货号/通道数 Order No./Poles No.		附件 Accessory	
IEC/UL数据 IEC/UL Data	IEC	UL		锁线螺钉 Locking crew	M3	MC-RBT5.0HXXC-0001	2-24	MC-JP5.0-XX	
额定电流 Rated current	[A]	18	15	扭矩 Torque	[N·m]	MC-RBT5.0HXXC-K-0001	2-24	MC-R-MSTB	
额定电压 Rated voltage	[V]	320	300	固定螺钉 Fixed screw	M2.5	MC-RBT/T5.0HXXC-0001	2-24		
硬导线截面积 Solid	[mm ²][AWG]	0.2-2.5	24-12	扭矩 Torque	[N·m]	MC-RBT/T5.0HXXC-K-0001	2-24		
柔性导线截面积 Flexible	[mm ²][AWG]	0.2-2.5	24-12	剥线长度 Strip length	[mm]				
额定冲击电压 Rated impulse voltage	[KV]	4	-						

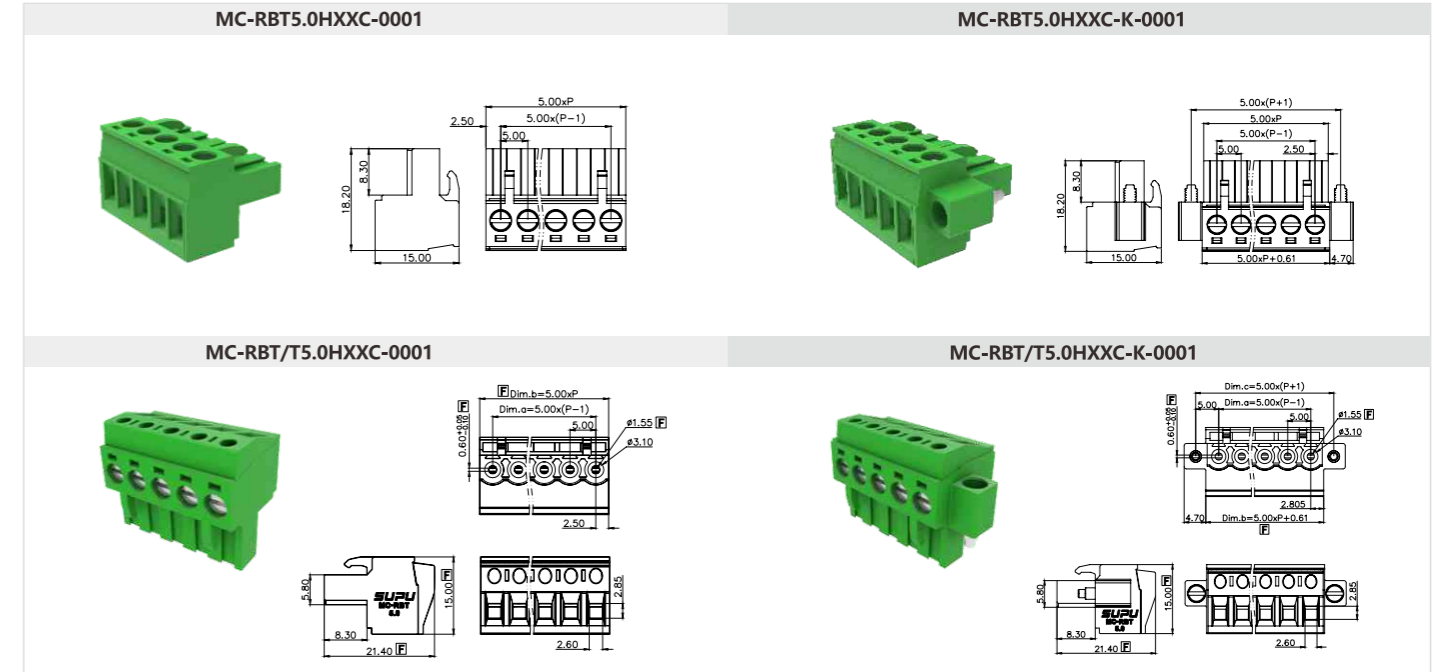

5.0mm间距 Pitch: 5.0mm

产品信息 Product Information				产品信息 Product Information		订货号/通道数 Order No./Poles No.		附件 Accessory	
IEC/UL数据 IEC/UL Data	IEC	UL		锁线螺钉 Locking crew	M3	MC-RE5.0VXXC-0001	2-24	MC-JP5.0-XX	
额定电流 Rated current	[A]	12	15	扭矩 Torque	[N·m]	MC-RE5.0VXXC-K-0001	2-24	MC-R-MSTB	
额定电压 Rated voltage	[V]	320	300	固定螺钉 Fixed screw	M2.5	MC-RE5.0VXXC-I-0001	2-24		
硬导线截面积 Solid	[mm ²][AWG]	0.2-2.5	24-12	扭矩 Torque	[N·m]	MC-RE5.0VXXC-R-0001	2-24		
柔性导线截面积 Flexible	[mm ²][AWG]	0.2-2.5	24-12	剥线长度 Strip length	[mm]	MC-RE5.0VXXC-RK-0001	2-24		
额定冲击电压 Rated impulse voltage	[KV]	4	-						

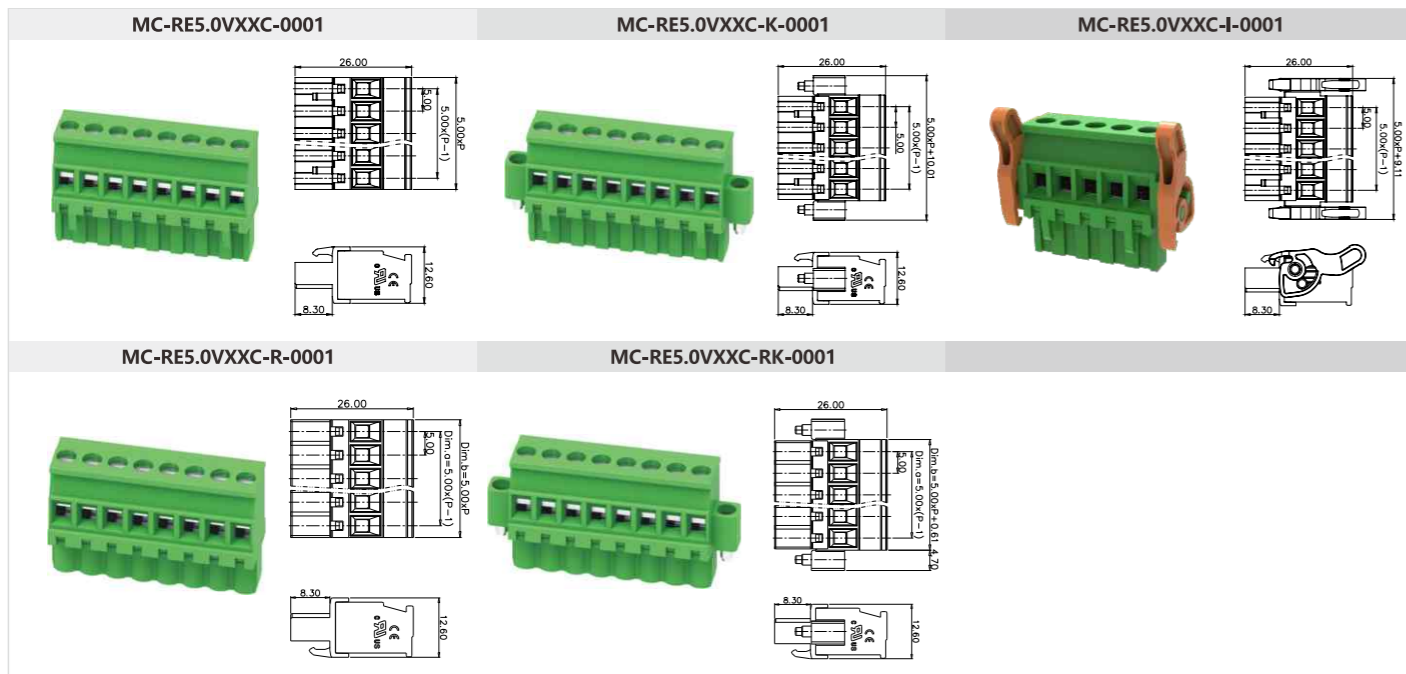

5.0mm间距 Pitch: 5.0mm

产品信息 Product Information				产品信息 Product Information		订货号/通道数 Order No./Poles No.		附件 Accessory	
IEC/UL数据 IEC/UL Data	IEC	UL		锁线螺钉 Locking crew	-	MC-RJ5.0HXXP-0001	2-24	MC-JP5.0-XX	
额定电流 Rated current	[A]	12	10	扭矩 Torque	[N·m]	MC-RJ5.0HXXP-K-0001	2-24	MC-R-MSTB	
额定电压 Rated voltage	[V]	320	300	固定螺钉 Fixed screw	M2.5	MC-RJ5.0HXXP-I-0001	2-24		
硬导线截面积 Solid	[mm ²][AWG]	0.2-2.5	24-12	扭矩 Torque	[N·m]	MC-RJ5.0HXXP-D-0001	2-24		
柔性导线截面积 Flexible	[mm ²][AWG]	0.2-2.5	24-12	剥线长度 Strip length	[mm]				
额定冲击电压 Rated impulse voltage	[KV]	4	-						

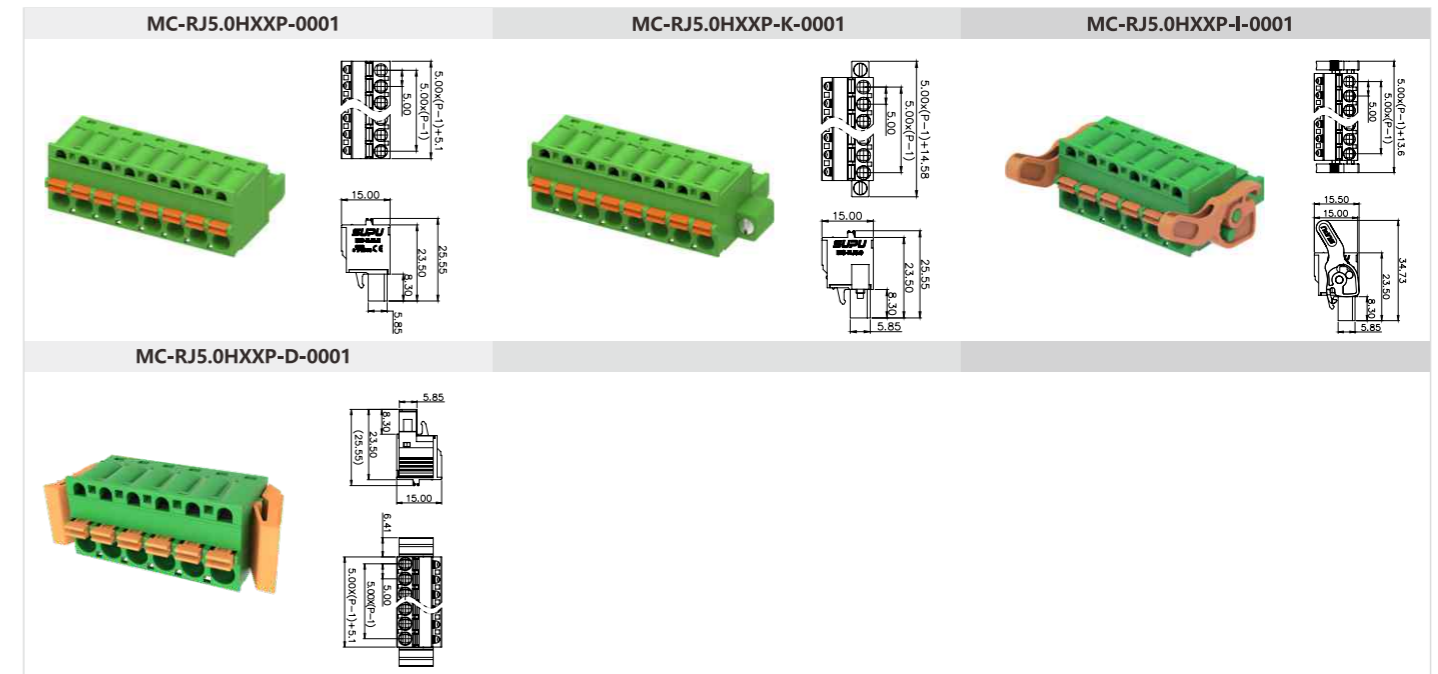

5.0mm间距 Pitch: 5.0mm

产品信息 Product Information			
IEC/UL数据 IEC/UL Data	IEC	UL	
额定电流 Rated current [A]	18	15	
额定电压 Rated voltage [V]	320	300	
硬导线截面积 Solid [mm ²][AWG]	-	-	
柔性导线截面积 Flexible [mm ²][AWG]	-	-	
额定冲击电压 Rated impulse voltage [KV]	4	-	

产品信息 Product Information		订货号/通道数 Order No./Poles No.	
锁线螺钉 Locking crew	-	MC-PA5.0VXX-0002	2-24
扭矩 Torque [N·m]	-	MC-PA5.0VXX-D-0002	2-24
固定螺母 Fixed screw	M2.5	MC-PA5.0VXX-F-0002	2-24
扭矩 Torque [N·m]	0.3	MC-PA5.0VXX-G-0002	2-24
剥线长度 Strip length [mm]	-	MC-PA5.0VXX-I-0002	2-24

产品信息 Product Information		订货号/通道数 Order No./Poles No.	
锁线螺钉 Locking crew	-	MC-PA5.0HXX-0002	2-24
扭矩 Torque [N·m]	-	MC-PA5.0HXX-D-0002	2-24
固定螺母 Fixed screw	M2.5	MC-PA5.0HXX-F-0002	2-24
扭矩 Torque [N·m]	0.3	MC-PA5.0HXX-G-0002	2-24
剥线长度 Strip length [mm]	-	MC-PA5.0HXX-I-0002	2-24

产品信息 Product Information		订货号/通道数 Order No./Poles No.	
锁线螺钉 Locking crew	-	MC-PA5.0VXX-0002	2-24
扭矩 Torque [N·m]	-	MC-PA5.0VXX-D-0002	2-24
固定螺母 Fixed screw	M2.5	MC-PA5.0VXX-F-0002	2-24
扭矩 Torque [N·m]	0.3	MC-PA5.0VXX-G-0002	2-24
剥线长度 Strip length [mm]	-	MC-PA5.0VXX-I-0002	2-24

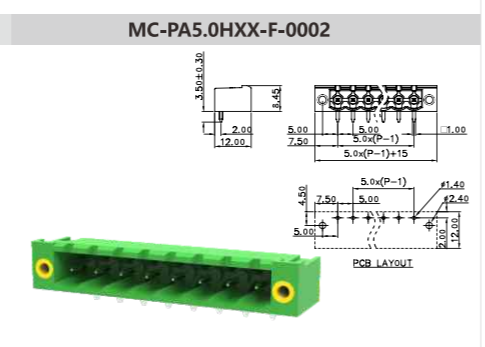
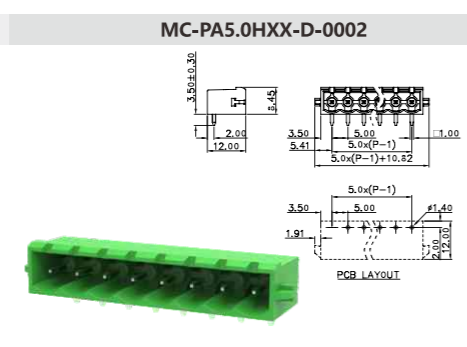
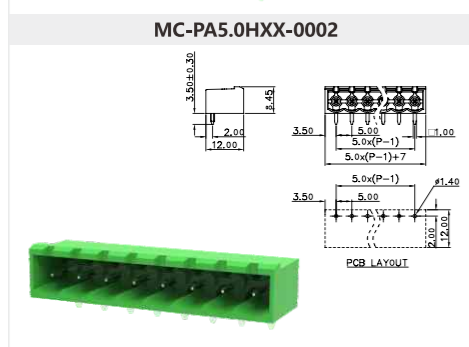
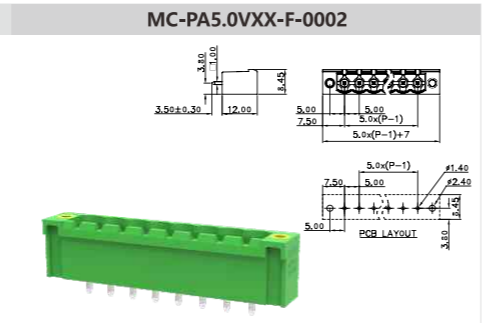
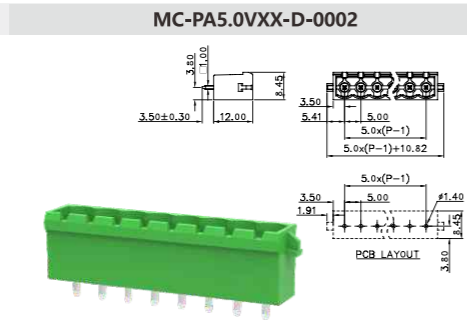
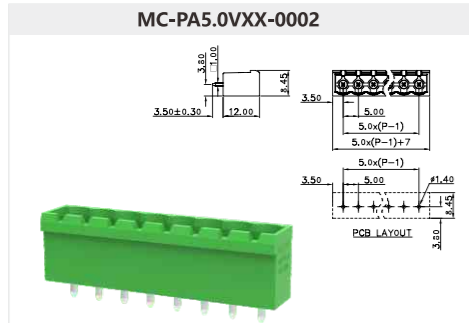

5.0mm间距 Pitch: 5.0mm

附件 Accessory	
MC-P-MSTB	

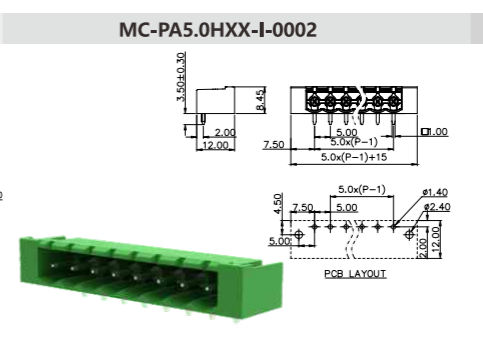
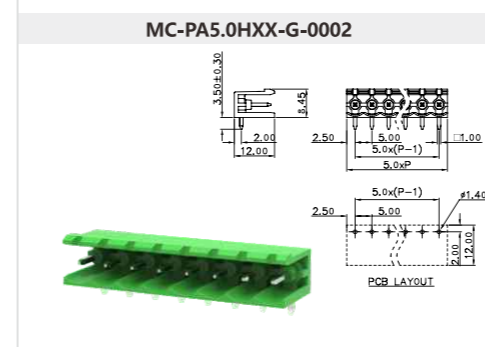
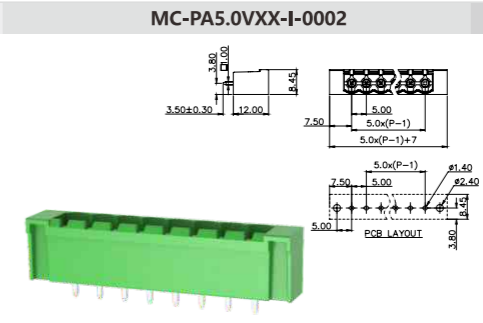
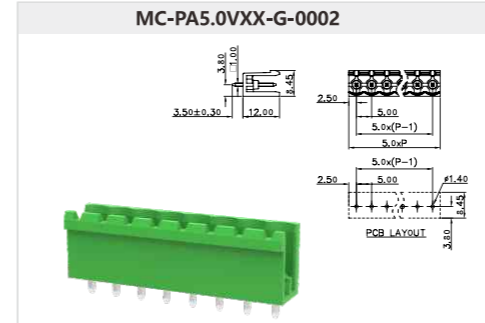

5.0mm间距 Pitch: 5.0mm

产品信息 Product Information			
IEC/UL数据 IEC/UL Data	IEC	UL	
额定电流 Rated current [A]	10	15	
额定电压 Rated voltage [V]	320	300	
硬导线截面积 Solid [mm ²][AWG]	-	-	
柔性导线截面积 Flexible [mm ²][AWG]	-	-	
额定冲击电压 Rated impulse voltage [KV]	4	-	

产品信息 Product Information		订货号/通道数 Order No./Poles No.	
锁线螺钉 Locking crew	-	MC-DPA5.0HXX-0002	4-48
扭矩 Torque [N·m]	-	MC-DPA5.0HXX-F-0002	4-48
固定螺母 Fixed screw	M2.5	MC-DPA5.0VXX-0002	4-48
扭矩 Torque [N·m]	-	MC-DPA5.0VXX-F-0002	4-48

产品信息 Product Information		订货号/通道数 Order No./Poles No.	
锁线螺钉 Locking crew	-	MC-DPA5.0HXX-0002	4-48
扭矩 Torque [N·m]	-	MC-DPA5.0HXX-F-0002	4-48
固定螺母 Fixed screw	M2.5	MC-DPA5.0VXX-0002	4-48
扭矩 Torque [N·m]	-	MC-DPA5.0VXX-F-0002	4-48

附件 Accessory	
MC-JP5.0-XX	

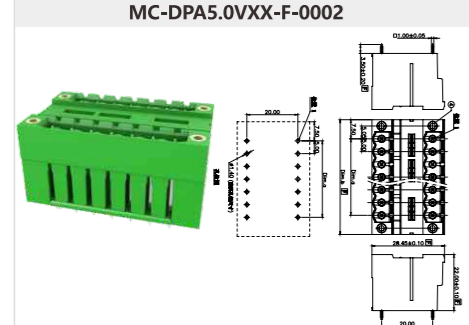
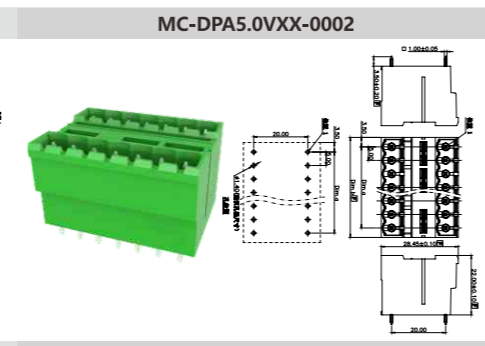
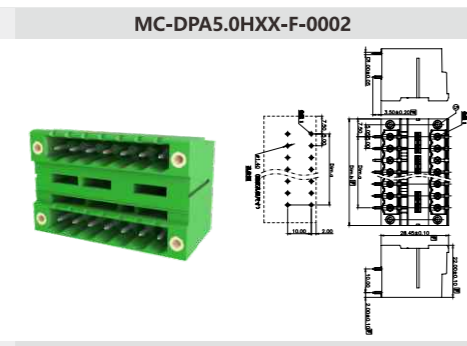
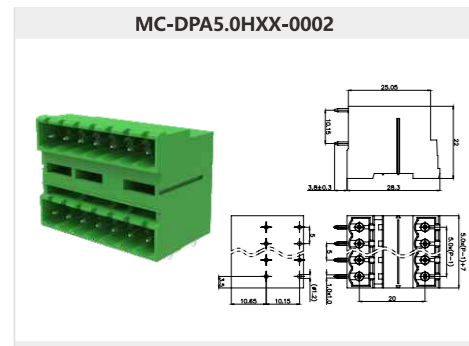

5.0mm间距 Pitch: 5.0mm

产品信息 Product Information			
IEC/UL数据 IEC/UL Data	IEC	UL	
额定电流 Rated current [A]	12	16	
额定电压 Rated voltage [V]	320	300	
硬导线截面积 Solid [mm ²][AWG]	-	-	
柔性导线截面积 Flexible [mm ²][AWG]	-	-	
额定冲击电压 Rated impulse voltage [KV]	4	-	

产品信息 Product Information		订货号/通道数 Order No./Poles No.	
锁线螺钉 Locking crew	-	MC-PAL5.0H02-0002	2
扭矩 Torque [N·m]	-	MC-PAL5.0H03-0002	3
固定螺母 Fixed screw	-	MC-PAL5.0H04-0002	4
扭矩 Torque [N·m]	-	MC-PAR5.0H02-0002	2
剥线长度 Strip length [mm]	-	MC-PAR5.0H03-0002	3
		MC-PAR5.0H04-0002	4

产品信息 Product Information		订货号/通道数 Order No./Poles No.	
锁线螺钉 Locking crew	-	MC-PAL5.0H02-0002	2
扭矩 Torque [N·m]	-	MC-PAL5.0H03-0002	3
固定螺母 Fixed screw	-	MC-PAL5.0H04-0002	4
扭矩 Torque [N·m]	-	MC-PAR5.0H02-0002	2
剥线长度 Strip length [mm]	-	MC-PAR5.0H03-0002	3
		MC-PAR5.0H04-0002	4

附件 Accessory	
MC-P-MSTB	

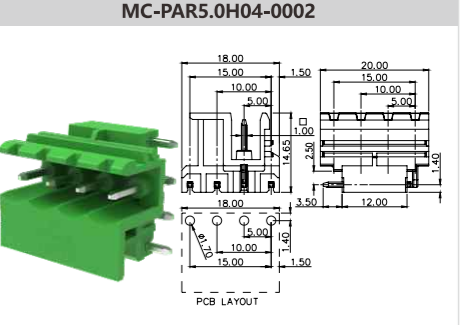
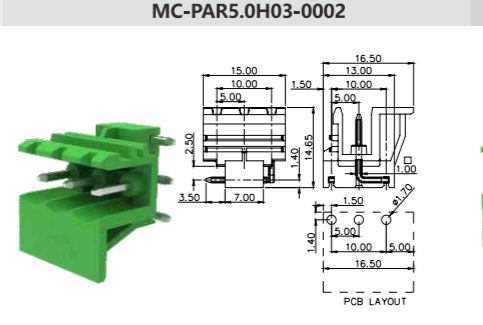
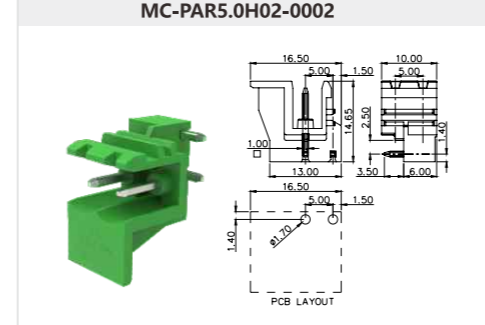
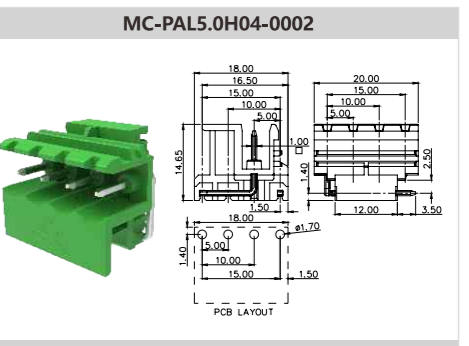
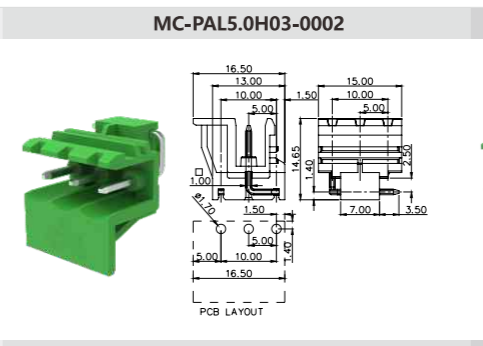
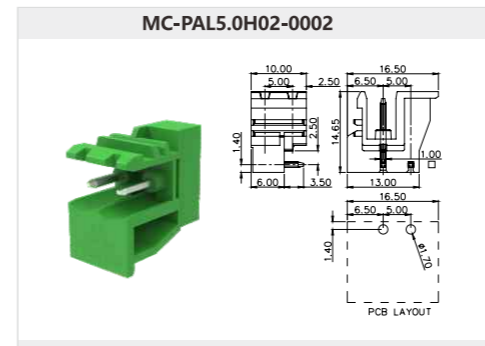

5.0mm间距 Pitch: 5.0mm

产品信息Product Information				产品信息Product Information		订货号/通道数 Order No./Poles No.		附件Accessory	
IEC/UL数据 IEC/UL Data	IEC	UL		锁线螺钉 Locking crew	-	MC-ROX5.0HXXP-0001	2-12	MC-JT7.5	
额定电流 Rated current [A]	20	15		扭矩 Torque [N·m]	-	MC-ROY5.0HXXP-0001	2-12		
额定电压 Rated voltage [V]	320	300		固定螺钉 Fixed screw	-	MC-ROX5.0HXXP-0002	2-12		
硬导线截面积 Solid [mm ²][AWG]	0.2-2.5	-		扭矩 Torque [N·m]	-				
柔性导线截面积 Flexible [mm ²][AWG]	0.2-2.5	-		剥线长度 Strip length [mm]	8-9				
额定冲击电压 Rated impulse voltage [KV]	4	-							

MC-ROX5.0HXXP-0001

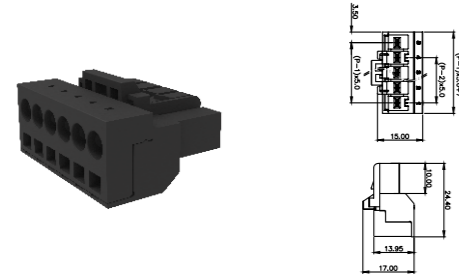

MC-ROY5.0HXXP-0001

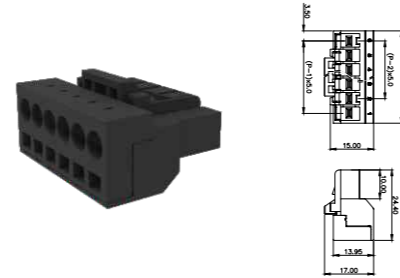

MC-ROX5.0HXXP-0002

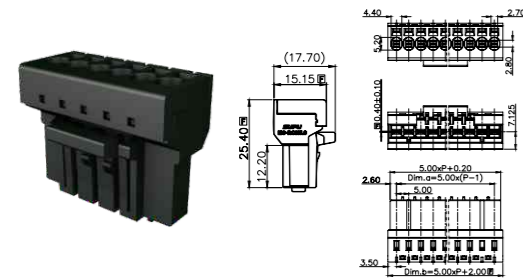

5.0mm间距 Pitch: 5.0mm

产品信息Product Information				产品信息Product Information		订货号/通道数 Order No./Poles No.		附件Accessory	
IEC/UL数据 IEC/UL Data	IEC	UL		锁线螺钉 Locking crew	-	MC-POX5.0HXX-0001	2-12		
额定电流 Rated current [A]	15	15		扭矩 Torque [N·m]	-	MC-POY5.0HXX-0001	2-12		
额定电压 Rated voltage [V]	320	300		固定螺钉 Fixed screw	-	MC-POX5.0HXX-0002	2-12		
硬导线截面积 Solid [mm ²][AWG]	-	-		扭矩 Torque [N·m]	-				
柔性导线截面积 Flexible [mm ²][AWG]	-	-		剥线长度 Strip length [mm]	-				
额定冲击电压 Rated impulse voltage [KV]	4	-							

MC-POX5.0HXX-0001

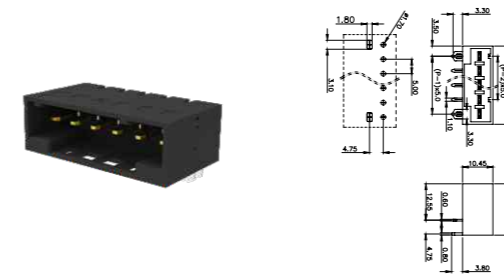

MC-POY5.0HXX-0001

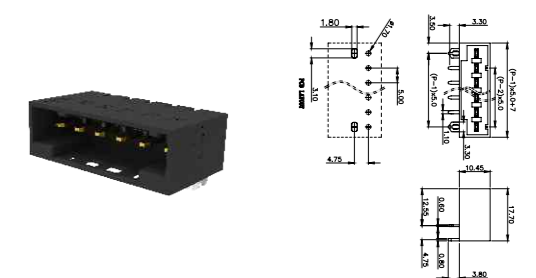

MC-POX5.0HXX-0002

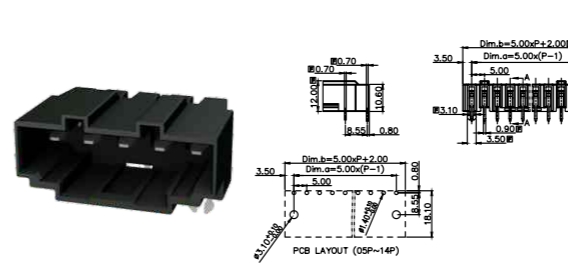

5.08mm间距 Pitch: 5.08mm

产品信息Product Information				产品信息Product Information		订货号/通道数 Order No./Poles No.		附件Accessory	
IEC/UL数据 IEC/UL Data	IEC	UL		锁线螺钉 Locking crew	M2	MC-RA5.08HXXC-0001	2-24		
额定电流 Rated current [A]	8	8		扭矩 Torque [N·m]	0.2 <td>MC-RA5.08HXXC-K-0001 <td>2-24 <td></td> <td></td> </td></td>	MC-RA5.08HXXC-K-0001 <td>2-24 <td></td> <td></td> </td>	2-24 <td></td> <td></td>		
额定电压 Rated voltage [V]	320	300		固定螺钉 Fixed screw <td>M2.5 <td>MC-RA5.08HXXC-I-0001 <td>2-24 <td></td> <td></td> </td></td></td>	M2.5 <td>MC-RA5.08HXXC-I-0001 <td>2-24 <td></td> <td></td> </td></td>	MC-RA5.08HXXC-I-0001 <td>2-24 <td></td> <td></td> </td>	2-24 <td></td> <td></td>		
硬导线截面积 Solid [mm ²][AWG]	0.2-1.5	24-16		扭矩 Torque [N·m]	0.3				
柔性导线截面积 Flexible [mm ²][AWG]	0.2-1.5	24-16		剥线长度 Strip length [mm]	7-8				
额定冲击电压 Rated impulse voltage [KV]	4	-							

MC-RA5.08HXXC-0001

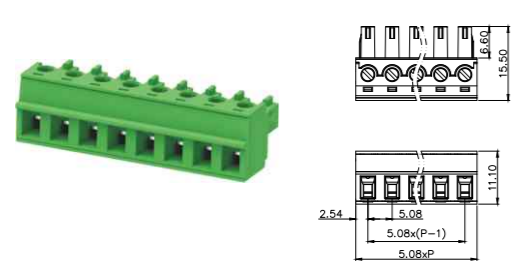

MC-RA5.08HXXC-K-0001

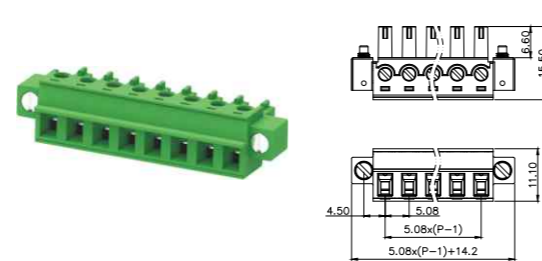

MC-RA5.08HXXC-I-0001

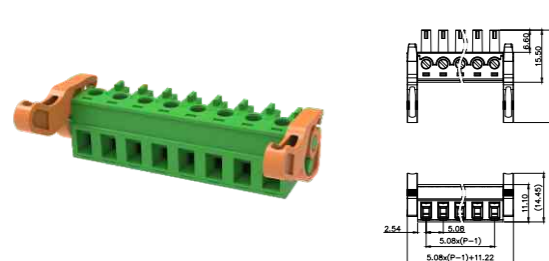

5.08mm间距 Pitch: 5.08mm

产品信息Product Information				产品信息Product Information		订货号/通道数 Order No./Poles No.		附件Accessory	
IEC/UL数据 IEC/UL Data	IEC	UL		锁线螺钉 Locking crew	M3	MC-RB5.08HXXC-0001	2-24	MC-WG5.0-X	
额定电流 Rated current [A]	18	15		扭矩 Torque [N·m]	0.5 <td>MC-RB5.08HXXC-K-0001 <td>2-24 <td>MC-GW5.08-XX</td> <td></td> </td></td>	MC-RB5.08HXXC-K-0001 <td>2-24 <td>MC-GW5.08-XX</td> <td></td> </td>	2-24 <td>MC-GW5.08-XX</td> <td></td>	MC-GW5.08-XX	
额定电压 Rated voltage [V]	320	300		固定螺钉 Fixed screw <td>M2.5 <td>MC-RB5.08HXXC-I-0001 <td>2-24 <td>MC-JP5.0-X</td> <td></td> </td></td></td>	M2.5 <td>MC-RB5.08HXXC-I-0001 <td>2-24 <td>MC-JP5.0-X</td> <td></td> </td></td>	MC-RB5.08HXXC-I-0001 <td>2-24 <td>MC-JP5.0-X</td> <td></td> </td>	2-24 <td>MC-JP5.0-X</td> <td></td>	MC-JP5.0-X	
硬导线截面积 Solid [mm ²][AWG]	0.2-2.5	24-12		扭矩 Torque [N·m]	0.3			MC-R-MSTB	
柔性导线截面积 Flexible [mm ²][AWG]	0.2-2.5	24-12		剥线长度 Strip length [mm]	7-8				
额定冲击电压 Rated impulse voltage [KV]	4	-							

MC-RB5.08HXXC-0001

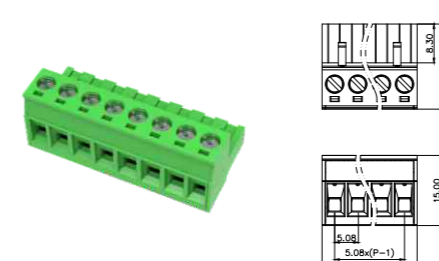

MC-RB5.08HXXC-K-0001

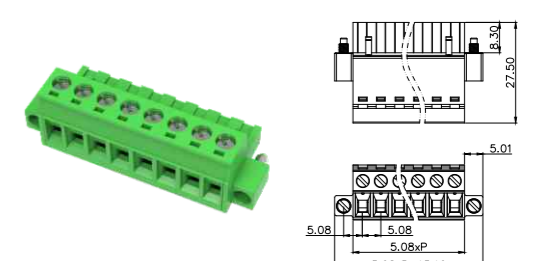

MC-RB5.08HXXC-I-0001

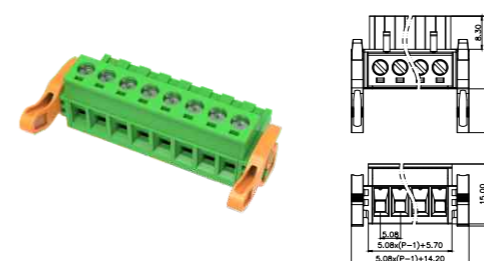

5.08mm间距 Pitch: 5.08mm

产品信息 Product Information				产品信息 Product Information				附件 Accessory			
IEC/UL数据 IEC/UL Data	IEC	UL		锁线螺钉 Locking crew	M3	订货号/通道数 Order No./Poles No.		MC-JP5.0-XX			
额定电流 Rated current	[A]	12	15	扭矩 Torque	[N·m]	0.5	MC-RB5.08HXXB/100-0001	2-24	MC-R-MSTB		
额定电压 Rated voltage	[V]	320	300	固定螺钉 Fixed screw	M2.5	MC-RB5.08HXXB-I-0001	2-24				
硬导线截面积 Solid	[mm ²][AWG]	0.2-2.5	24-12	扭矩 Torque	[N·m]	0.3	MC-RB5.08HXXB-I/100-0001	2-24			
柔性导线截面积 Flexible	[mm ²][AWG]	0.2-2.5	24-12	剥线长度 Strip length	[mm]	7-8	MC-RB5.08HXXB-K-0001	2-24			
额定冲击电压 Rated impulse voltage	[KV]	4	-				MC-RB5.08HXXB-K/100-0001	2-24			

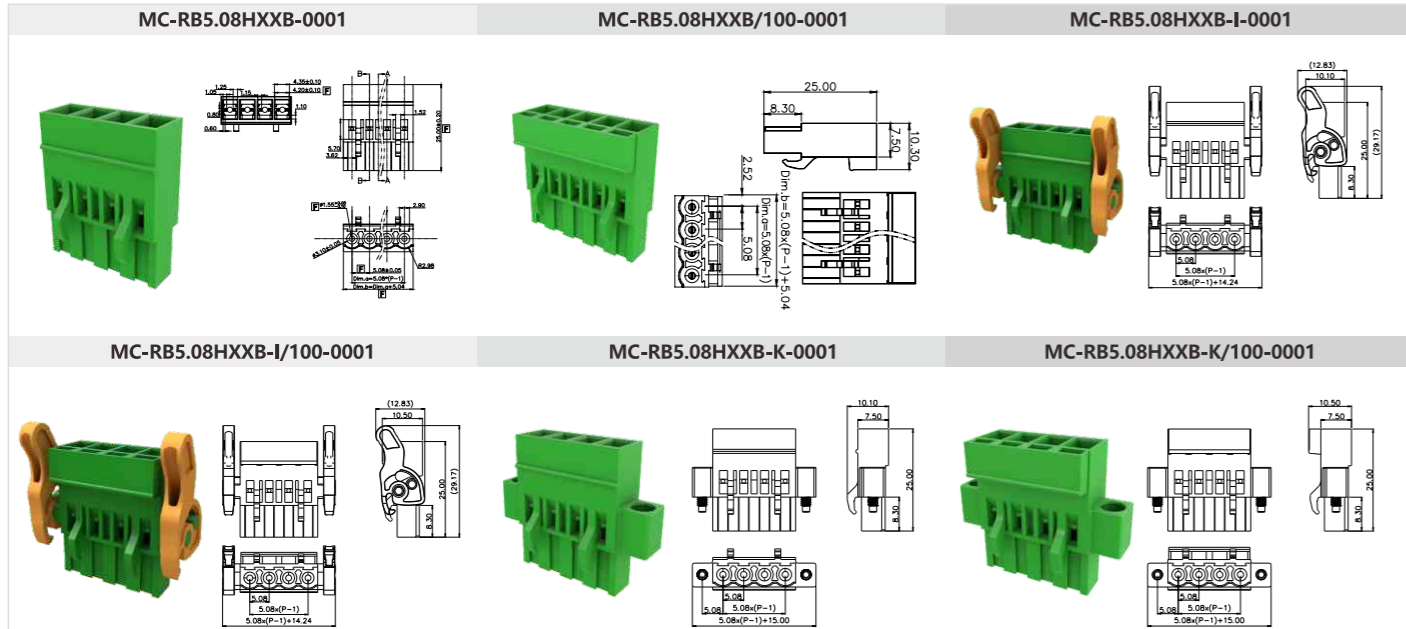

备注: 该系列成品无导电件, 与附件冷压头MC-RB5.08-03-3000, MC-RB5.08-10-3000, MC-RB5.08-25-3000配对使用

5.08mm间距 Pitch: 5.08mm

产品信息 Product Information				产品信息 Product Information			
IEC/UL数据 IEC/UL Data	IEC	UL		IEC/UL数据 IEC/UL Data	IEC	UL	
额定电流 Rated current	[A]	5	-	额定电流 Rated current	[A]	10	-
额定电压 Rated voltage	[V]	320	-	额定电压 Rated voltage	[V]	320	-
硬导线截面积 Solid	[mm ²][AWG]	-	-	硬导线截面积 Solid	[mm ²][AWG]	-	-
柔性导线截面积 Flexible	[mm ²][AWG]	0.2-0.34	-	柔性导线截面积 Flexible	[mm ²][AWG]	0.5-10	-
额定冲击电压 Rated impulse voltage	[KV]	4	-	额定冲击电压 Rated impulse voltage	[KV]	4	-
订货号/通道数 Order No./Poles No.				订货号/通道数 Order No./Poles No.			
MC-RB5.08-03-3000				MC-RB5.08-10-3000			

产品信息 Product Information			
IEC/UL数据 IEC/UL Data	IEC	UL	
额定电流 Rated current	[A]	12	-
额定电压 Rated voltage	[V]	320	-
硬导线截面积 Solid	[mm ²][AWG]	-	-
柔性导线截面积 Flexible	[mm ²][AWG]	1.5-2.5	-
额定冲击电压 Rated impulse voltage	[KV]	4	-
订货号/通道数 Order No./Poles No.			
MC-RB5.08-25-3000			

注: 导电件可配MC-RB5.08HXXB产品

5.08mm间距 Pitch: 5.08mm

产品信息 Product Information				产品信息 Product Information				附件 Accessory			
IEC/UL数据 IEC/UL Data	IEC	UL		锁线螺钉 Locking crew	M2.5	订货号/通道数 Order No./Poles No.		MC-RBF5.08HXXC-0001	2-24	MC-JP5.0-X	
额定电流 Rated current	[A]	18	15	扭矩 Torque	[N·m]	0.5	MC-RBF5.08HXXC-K-0001	2-24	MC-R-MSTB		
额定电压 Rated voltage	[V]	320	300	固定螺钉 Fixed screw	M2.5	MC-RBF5.08HXXC-I-0001	2-24				
硬导线截面积 Solid	[mm ²][AWG]	0.2-2.5	24-12	扭矩 Torque	[N·m]	0.3					
柔性导线截面积 Flexible	[mm ²][AWG]	0.2-2.5	24-12	剥线长度 Strip length	[mm]	11-12					
额定冲击电压 Rated impulse voltage	[KV]	4	-								

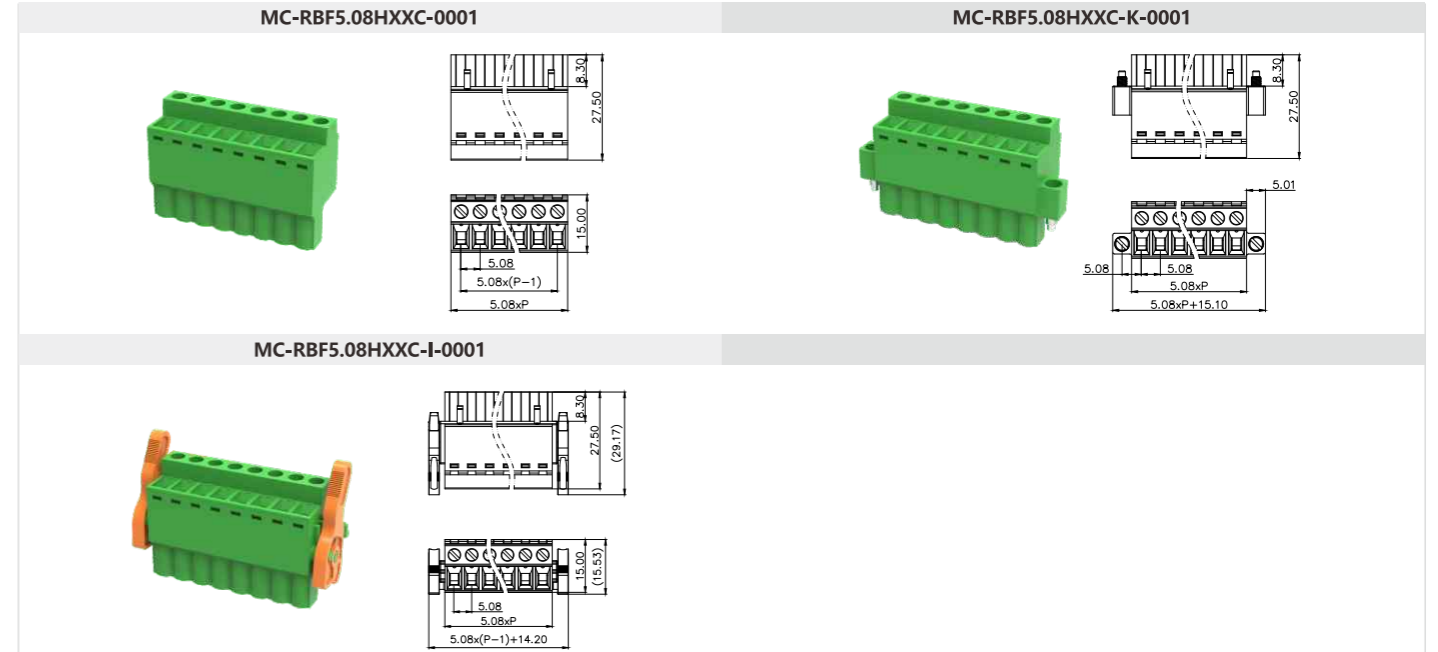

5.08mm间距 Pitch: 5.08mm

产品信息 Product Information				产品信息 Product Information				附件 Accessory			
IEC/UL数据 IEC/UL Data	IEC	UL		锁线螺钉 Locking crew	M3	订货号/通道数 Order No./Poles No.		MC-RE5.08VXXC-0001	2-24	MC-JP5.0-X	
额定电流 Rated current	[A]	12	15	扭矩 Torque	[N·m]	0.5	MC-RE5.08VXXC-K-0001	2-24	MC-R-MSTB		
额定电压 Rated voltage	[V]	320	300	固定螺钉 Fixed screw	M2.5	MC-RE5.08VXXC-I-0001	2-24				
硬导线截面积 Solid	[mm ²][AWG]	0.2-2.5	24-12	扭矩 Torque	[N·m]	0.3	MC-RE5.08VXXC-R-0001	2-24			
柔性导线截面积 Flexible	[mm ²][AWG]	0.2-2.5	24-12	剥线长度 Strip length	[mm]	7-8	MC-RE5.08VXXC-RK-0001	2-24			
额定冲击电压 Rated impulse voltage	[KV]	4	-								

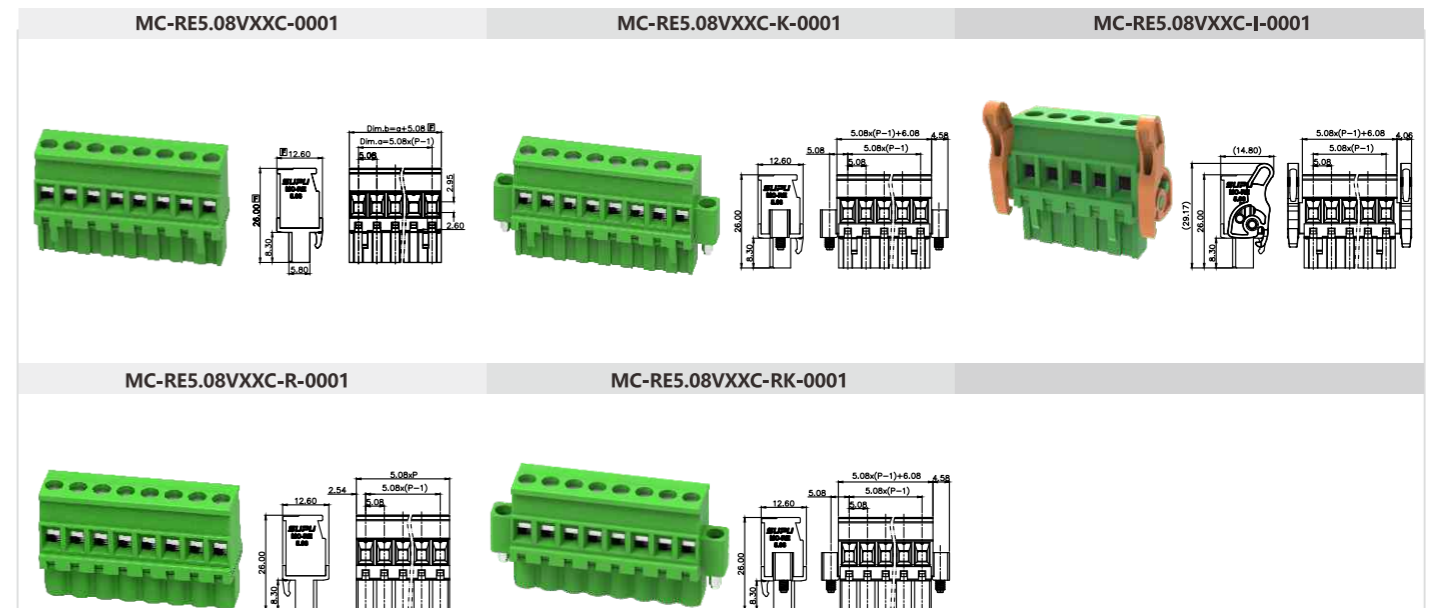

5.08mm间距 Pitch: 5.08mm

产品信息Product Information				产品信息Product Information				订货号/通道数 Order No./Poles No.		附件Accessory	
IEC/UL数据 IEC/UL Data	IEC	UL		锁线螺钉 Locking crew	-	MC-RN5.08VXXP-0001	2-24	MC-R-MSTB			
额定电流 Rated current [A]	12	15		扭矩 Torque [N·m]	-	MC-RN5.08VXXP-K-0001	2-24				
额定电压 Rated voltage [V]	320	300		固定螺钉 Fixed screw	M2.5	MC-RN5.08VXXP-R-0001	2-24				
硬导线截面积 Solid [mm ²][AWG]	0.2-2.5	24-12		扭矩 Torque [N·m]	0.3	MC-RN5.08VXXP-RK-0001	2-24				
柔性导线截面积 Flexible [mm ²][AWG]	0.2-2.5	24-12		剥线长度 Strip length [mm]	10-11						
额定冲击电压 Rated impulse voltage [KV]	4	-									

MC-RN5.08VXXP-0001

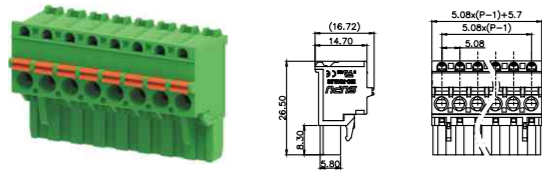

MC-RN5.08VXXP-K-0001

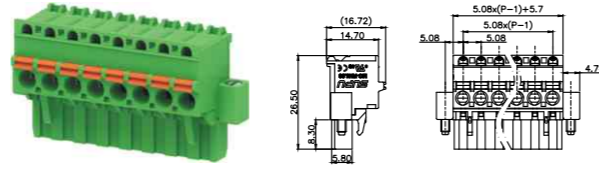

MC-RN5.08VXXP-R-0001

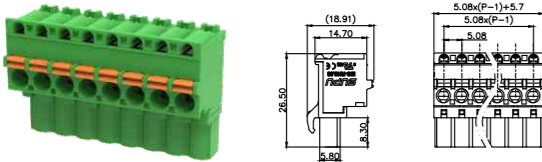

MC-RN5.08VXXP-RK-0001

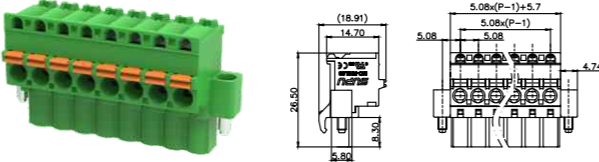

5.08mm间距 Pitch: 5.08mm

产品信息Product Information				产品信息Product Information				订货号/通道数 Order No./Poles No.		附件Accessory	
IEC/UL数据 IEC/UL Data	IEC	UL		锁线螺钉 Locking crew	-	MC-RJT5.08HXXP-0001	2-24	MC-R-MSTB			
额定电流 Rated current [A]	12	10		扭矩 Torque [N·m]	-	MC-RJT5.08HXXP-K-0001	2-24				
额定电压 Rated voltage [V]	320	300		固定螺钉 Fixed screw	M2.5						
硬导线截面积 Solid [mm ²][AWG]	0.2-2.5	24-12		扭矩 Torque [N·m]	0.3						
柔性导线截面积 Flexible [mm ²][AWG]	0.2-2.5	24-12		剥线长度 Strip length [mm]	10-11						
额定冲击电压 Rated impulse voltage [KV]	4	-									

MC-RJT5.08HXXP-0001

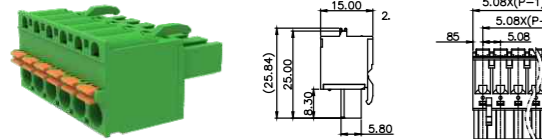

MC-RJT5.08HXXP-K-0001

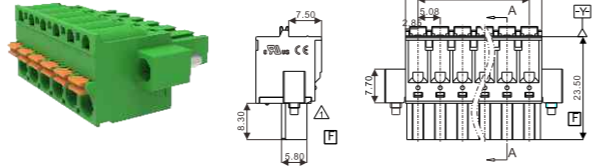

5.08mm间距 Pitch: 5.08mm

产品信息Product Information				产品信息Product Information				订货号/通道数 Order No./Poles No.		附件Accessory	
IEC/UL数据 IEC/UL Data	IEC	UL		锁线螺钉 Locking crew	-	MC-RJ5.08HXXP-0001	2-24	MC-R-MSTB			
额定电流 Rated current [A]	12	10		扭矩 Torque [N·m]	-	MC-RJ5.08HXXP-D-0001	2-24				
额定电压 Rated voltage [V]	320	300		固定螺钉 Fixed screw	M2.5	MC-RJ5.08HXXP-I-0001	2-24				
硬导线截面积 Solid [mm ²][AWG]	0.2-2.5	24-12		扭矩 Torque [N·m]	0.3	MC-RJ5.08HXXP-K-0001	2-24				
柔性导线截面积 Flexible [mm ²][AWG]	0.2-2.5	24-12		剥线长度 Strip length [mm]	10-11						
额定冲击电压 Rated impulse voltage [KV]	4	-									

MC-RJ5.08HXXP-0001

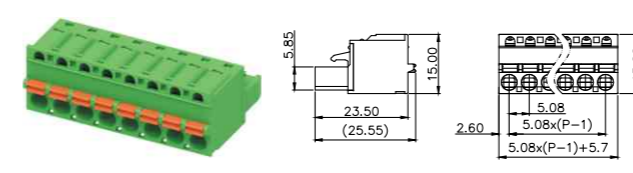

MC-RJ5.08HXXP-D-0001

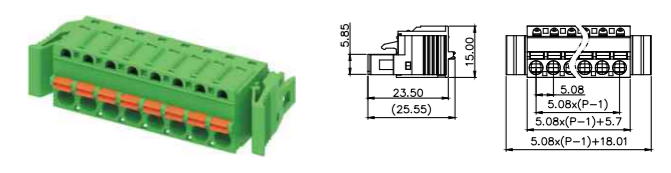

MC-RJ5.08HXXP-I-0001

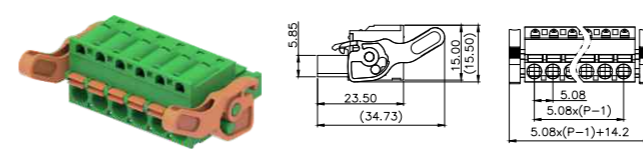

MC-RJ5.08HXXP-K-0001

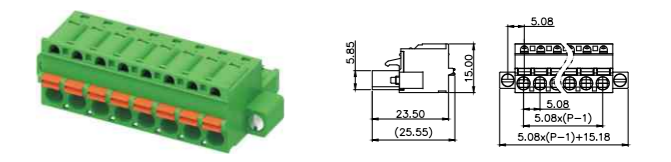

5.08mm间距 Pitch: 5.08mm

产品信息Product Information				产品信息Product Information				订货号/通道数 Order No./Poles No.		附件Accessory	
IEC/UL数据 IEC/UL Data	IEC	UL		锁线螺钉 Locking crew	-	MC-RS5.08HXXP-0001	2-24	MC-R-MSTB			
额定电流 Rated current [A]	18	15		扭矩 Torque [N·m]	-	MC-RS5.08HXXP-K-0001	2-24				
额定电压 Rated voltage [V]	320	300		固定螺钉 Fixed screw	M2.5	MC-RS5.08HXXP-I-0001	2-24				
硬导线截面积 Solid [mm ²][AWG]	0.2-2.5	24-12		扭矩 Torque [N·m]	0.3						
柔性导线截面积 Flexible [mm ²][AWG]	0.2-2.5	24-12		剥线长度 Strip length [mm]	12						
额定冲击电压 Rated impulse voltage [KV]	4	-									

MC-RS5.08HXXP-0001

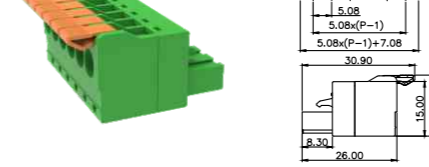

MC-RS5.08HXXP-K-0001

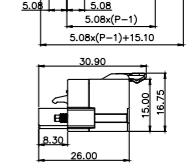

MC-RS5.08HXXP-I-0001

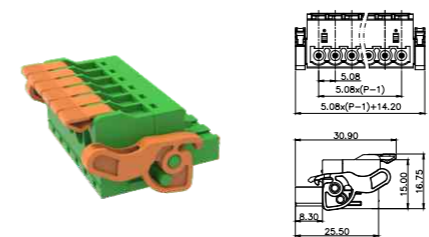

5.08mm间距 Pitch: 5.08mm

产品信息Product Information			产品信息Product Information			订货号/通道数 Order No./Poles No.		附件Accessory	
IEC/UL数据 IEC/UL Data	IEC	UL	锁线螺钉 Locking crew	-	MC-DRJ5.08HXXP-0001	2-24	MC-R-MSTB		
额定电流 Rated current [A]	12	12	扭矩 Torque [N·m]	-	MC-DRJ5.08HXXP-K-0001	2-24			
额定电压 Rated voltage [V]	320	300	固定螺钉 Fixed screw	M2.5	MC-DRJ5.08HXXP-I-0001	2-24			
硬导线截面积 Solid [mm ²][AWG]	0.2-2.5	24-12	扭矩 Torque [N·m]	0.3					
柔性导线截面积 Flexible [mm ²][AWG]	0.2-2.5	24-12	剥线长度 Strip length [mm]	11-12					
额定冲击电压 Rated impulse voltage [KV]	4	-							

MC-DRJ5.08HXXP-0001

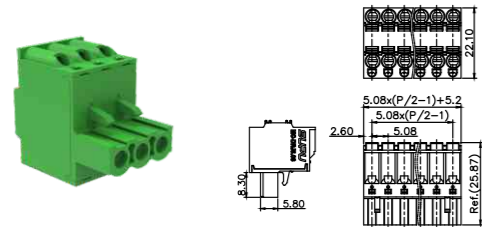

MC-DRJ5.08HXXP-K-0001

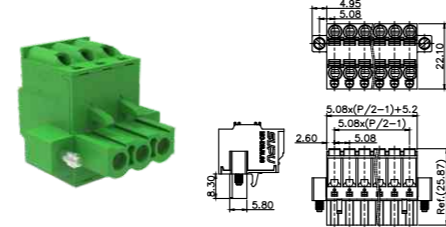

MC-DRJ5.08HXXP-I-0001

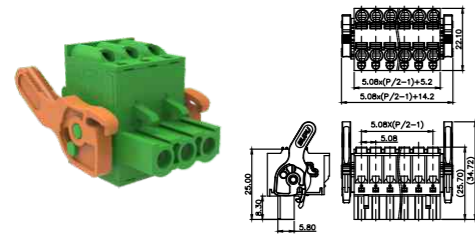

5.08mm间距 Pitch: 5.08mm

产品信息Product Information			产品信息Product Information			订货号/通道数 Order No./Poles No.		附件Accessory	
IEC/UL数据 IEC/UL Data	IEC	UL	锁线螺钉 Locking crew	-	MC-RP5.08HXXP-0001	2-24	MC-R-MSTB		
额定电流 Rated current [A]	18	15	扭矩 Torque [N·m]	-	MC-RP5.08HXXP-K-0001	2-24			
额定电压 Rated voltage [V]	320	300	固定螺钉 Fixed screw	M2.5	MC-RP5.08HXXP-I-0001	2-24			
硬导线截面积 Solid [mm ²][AWG]	0.2-2.5	24-12	扭矩 Torque [N·m]	0.3					
柔性导线截面积 Flexible [mm ²][AWG]	0.2-2.5	24-12	剥线长度 Strip length [mm]	10-11					
额定冲击电压 Rated impulse voltage [KV]	4	-							

MC-RP5.08HXXP-0001

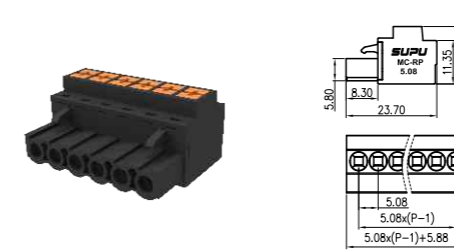

MC-RP5.08HXXP-K-0001

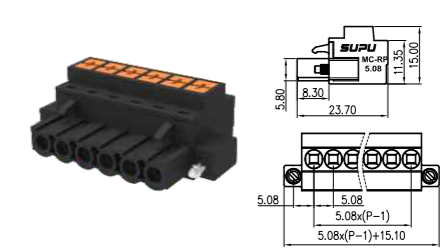

MC-RP5.08HXXP-I-0001



5.08mm间距 Pitch: 5.08mm

产品信息Product Information			产品信息Product Information			订货号/通道数 Order No./Poles No.		订货号/通道数 Order No./Poles No.	
IEC/UL数据 IEC/UL Data	IEC	UL	锁线螺钉 Locking crew	-	MC-PJ5.08HXXP-0001	2-24	MC-PJ5.08HXXP-I-0001	2-24	
额定电流 Rated current [A]	12	10	扭矩 Torque [N·m]	-	MC-PJ5.08HXXP-B-0001	2-24	MC-PJ5.08HXXP-K-0001	2-24	
额定电压 Rated voltage [V]	300	300	固定螺钉 Fixed screw	-	MC-PJ5.08HXXP-D-0001	2-24			
硬导线截面积 Solid [mm ²][AWG]	0.2-2.5	-	扭矩 Torque [N·m]	-	MC-PJ5.08HXXP-DB-0001	2-24			
柔性导线截面积 Flexible [mm ²][AWG]	0.2-2.5	-	剥线长度 Strip length [mm]	10-11	MC-PJ5.08HXXP-F-0001	2-24			
额定冲击电压 Rated impulse voltage [KV]	4	-							

5.08mm间距 Pitch: 5.08mm

附件Accessory	
MC-P-MSTB	

MC-PJ5.08HXXP-0001

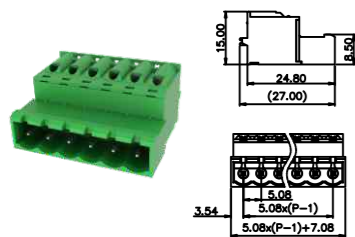

MC-PJ5.08HXXP-B-0001

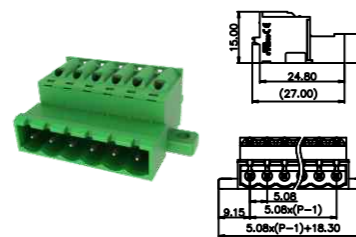

MC-PJ5.08HXXP-D-0001

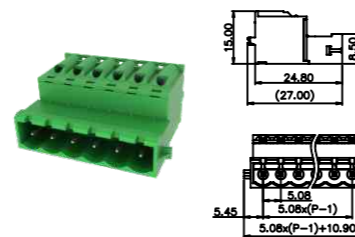

MC-PJ5.08HXXP-I-0001

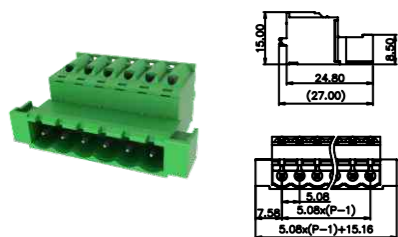

MC-PJ5.08HXXP-K-0001

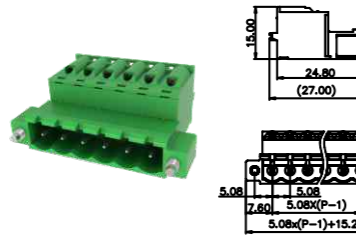

MC-PJ5.08HXXP-DB-0001

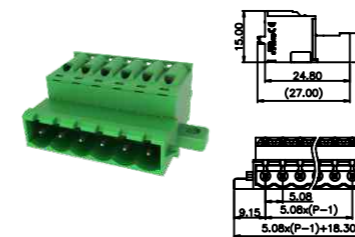

MC-PJ5.08HXXP-F-0001

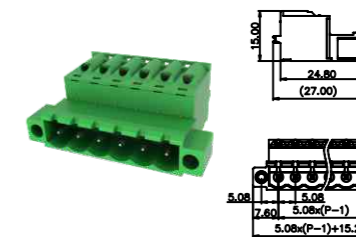

5.08mm间距 Pitch: 5.08mm

产品信息 Product Information			
IEC/UL数据 IEC/UL Data	IEC	UL	
额定电流 Rated current	[A] 18	15	
额定电压 Rated voltage	[V] 320	300	
硬导线截面积 Solid [mm ²][AWG]	-	-	
柔性导线截面积 Flexible [mm ²][AWG]	-	-	
额定冲击电压 Rated impulse voltage	[KV] 4	-	

产品信息 Product Information			
锁线螺钉 Locking crew	扭矩 Torque	固定螺钉 Fixed screw	扭矩 Torque
-	[N·m] -	M2.5	[N·m] 0.3
剥线长度 Strip length	[mm] -		

订货号/通道数 Order No./Poles No.	订货号/通道数 Order No./Poles No.	订货号/通道数 Order No./Poles No.
MC-PA5.08HXX-0002 2-24	MC-PA5.08VXX-0002 2-24	MC-PA5.08HXX-F-0002 2-24
MC-PA5.08HXX-D-0002 2-24	MC-PA5.08VXX-F-0002 2-24	MC-PA5.08VXX-G-0002 2-24
MC-PA5.08HXX-G-0002 2-24	MC-PA5.08VXX-I-0002 2-24	

5.08mm间距 Pitch: 5.08mm

附件 Accessory	
MC-P-MSTB	

<p>MC-PA5.08HXX-0002</p>	<p>MC-PA5.08HXX-D-0002</p>	<p>MC-PA5.08HXX-F-0002</p>
<p>MC-PA5.08VXX-0002</p>	<p>MC-PA5.08VXX-D-0002</p>	<p>MC-PA5.08VXX-F-0002</p>

<p>MC-PA5.08HXX-G-0002</p>	<p>MC-PA5.08HXX-I-0002</p>
<p>MC-PA5.08VXX-G-0002</p>	<p>MC-PA5.08VXX-I-0002</p>

5.08mm间距 Pitch: 5.08mm

产品信息 Product Information			
IEC/UL数据 IEC/UL Data	IEC	UL	
额定电流 Rated current	[A] 12	10	
额定电压 Rated voltage	[V] 320	300	
硬导线截面积 Solid [mm ²][AWG]	0.2-2.5	24-12	
柔性导线截面积 Flexible [mm ²][AWG]	0.2-2.5	24-12	
额定冲击电压 Rated impulse voltage	[KV] 4	-	

产品信息 Product Information			
锁线螺钉 Locking crew	扭矩 Torque	固定螺钉 Fixed screw	扭矩 Torque
M3	[N·m] 0.5	M2.5	[N·m] 0.3
剥线长度 Strip length	[mm] 7-8		

订货号/通道数 Order No./Poles No.	订货号/通道数 Order No./Poles No.	订货号/通道数 Order No./Poles No.
MC-PB5.08HXXC-0001 2-24	MC-PB5.08HXXC-IB-0001 2-24	MC-PB5.08HXXC-K-0001 2-24
MC-PB5.08HXXC-B-0001 2-24	MC-PB5.08HXXC-KB-0001 2-24	MC-PB5.08HXXC-S-0001 2-24
MC-PB5.08HXXC-F-0001 2-24	MC-PB5.08HXXC-FB-0001 2-24	MC-PB5.08HXXC-SF-0001 2-24
MC-PB5.08HXXC-I-0001 2-24	MC-PB5.08HXXC-SI-0001 2-24	MC-PB5.08HXXC-SK-0001 2-24

5.08mm间距 Pitch: 5.08mm

附件 Accessory	
MC-PB5.08HXXC-SI-0001 2-24	MC-JP5.0-X
MC-PB5.08HXXC-SK-0001 2-24	MC-P-MSTB

<p>MC-PB5.08HXXC-0001</p>	<p>MC-PB5.08HXXC-B-0001</p>	<p>MC-PB5.08HXXC-F-0001</p>
<p>MC-PB5.08HXXC-K-0001</p>	<p>MC-PB5.08HXXC-KB-0001</p>	<p>MC-PB5.08HXXC-S-0001</p>

<p>MC-PB5.08HXXC-FB-0001</p>	<p>MC-PB5.08HXXC-I-0001</p>	<p>MC-PB5.08HXXC-IB-0001</p>
<p>MC-PB5.08HXXC-SF-0001</p>	<p>MC-PB5.08HXXC-SI-0001</p>	<p>MC-PB5.08HXXC-SK-0001</p>

5.08mm间距 Pitch: 5.08mm

产品信息 Product Information		产品信息 Product Information		订货号/通道数 Order No./Poles No.		附件 Accessory	
IEC/UL数据 IEC/UL Data		锁线螺钉 Locking crew	-	MC-PD5.08HXX-0001	2-24	MC-R-MSTB3.81	
额定电流 Rated current [A]	8	扭矩 Torque [N·m]	-	MC-PD5.08HXX-F-0001	2-24		
额定电压 Rated voltage [V]	320	固定螺钉 Fixed screw M2.5	MC-PD5.08HXX-I-0001	2-24			
硬导线截面积 Solid [mm²][AWG]	-	扭矩 Torque [N·m]	0.3	MC-PD5.08VXX-0001	2-24		
柔性导线截面积 Flexible [mm²][AWG]	-	剥线长度 Strip length [mm]	-	MC-PD5.08VXX-F-0001	2-24		
额定冲击电压 Rated impulse voltage [KV]	4			MC-PD5.08VXX-I-0001	2-24		

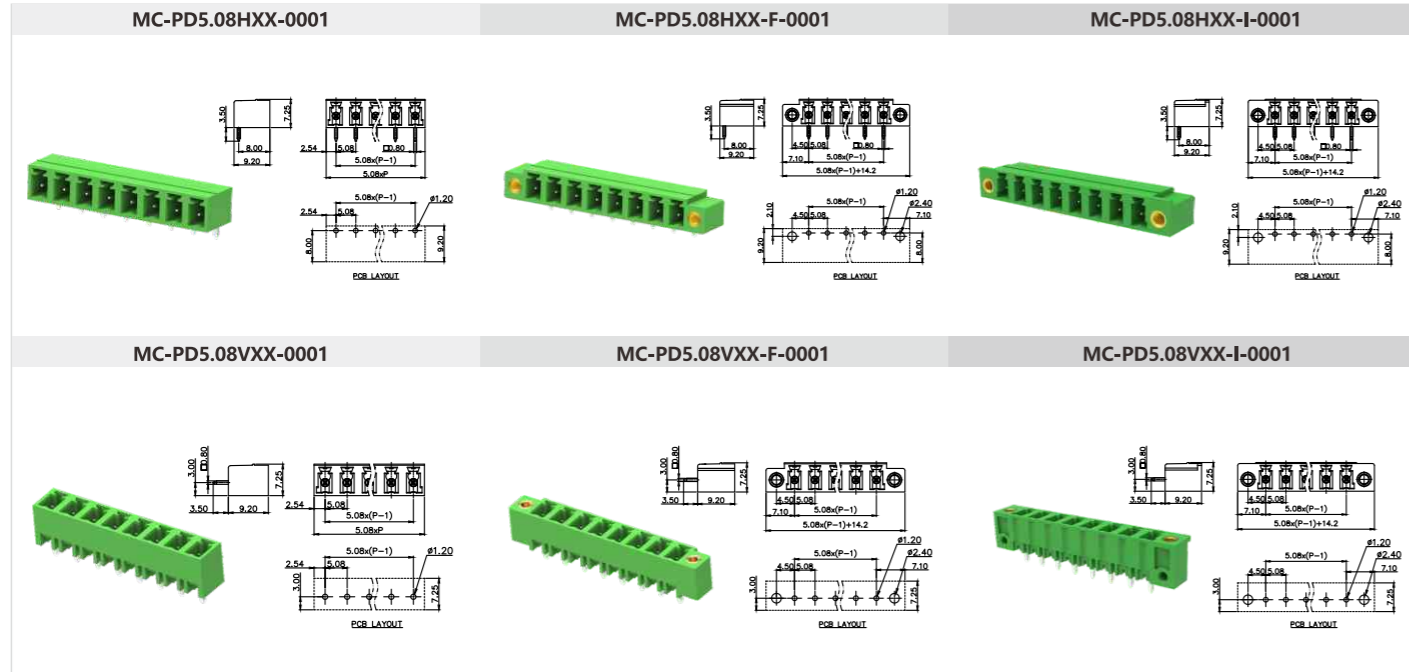

5.08mm间距 Pitch: 5.08mm

产品信息 Product Information		产品信息 Product Information		订货号/通道数 Order No./Poles No.		附件 Accessory	
IEC/UL数据 IEC/UL Data		锁线螺钉 Locking crew	-	MC-DPA5.08HXX-0002	4-48	MC-P-MSTB-0001	
额定电流 Rated current [A]	10	扭矩 Torque [N·m]	-	MC-DPA5.08HXX-F-0002	4-48		
额定电压 Rated voltage [V]	320	固定螺钉 Fixed screw M2.5	MC-DPA5.08VXX-0002	4-48			
硬导线截面积 Solid [mm²][AWG]	-	扭矩 Torque [N·m]	0.3	MC-DPA5.08VXX-F-0002	4-48		
柔性导线截面积 Flexible [mm²][AWG]	-	剥线长度 Strip length [mm]	-				
额定冲击电压 Rated impulse voltage [KV]	4						

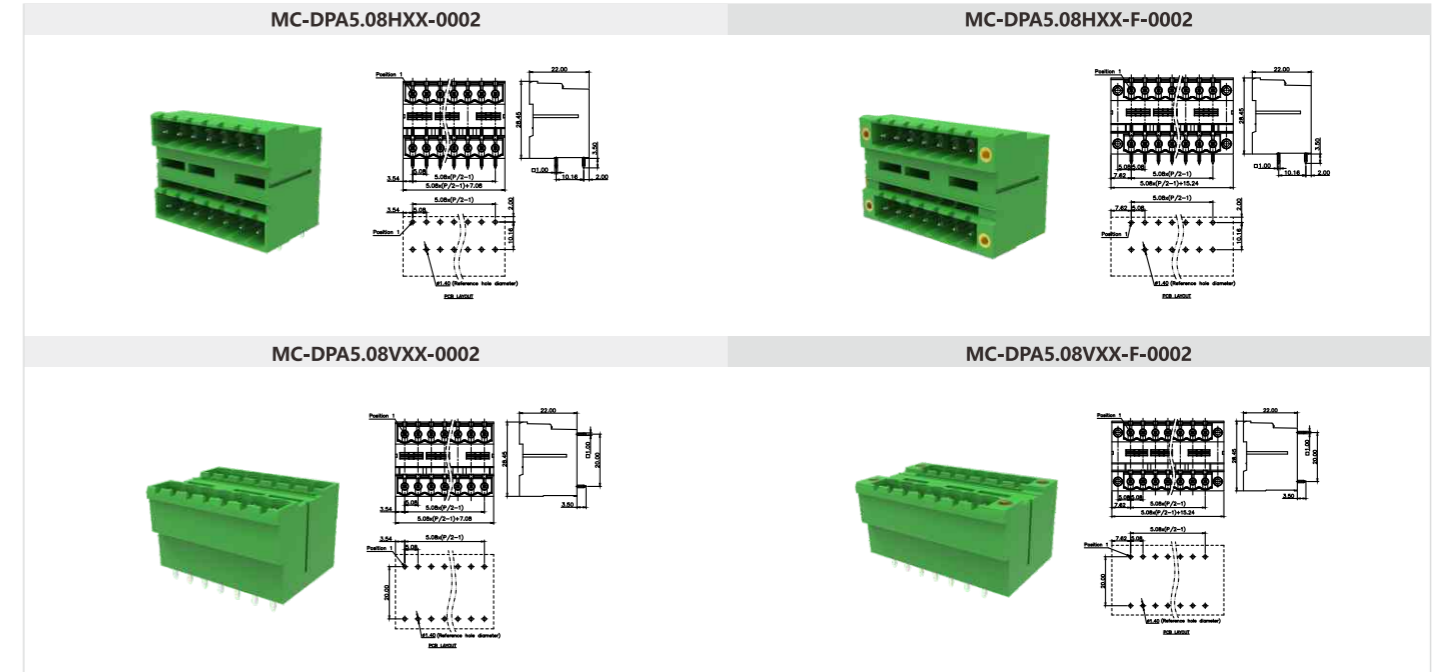

5.08mm间距 Pitch: 5.08mm

产品信息 Product Information		产品信息 Product Information		订货号/通道数 Order No./Poles No.		订货号/通道数 Order No./Poles No.	
IEC/UL数据 IEC/UL Data		锁线螺钉 Locking crew	-	MC-DPAB5.08HXX-0001	4-48	MC-DPAB5.08VXX-G-0001	4-48
额定电流 Rated current [A]	10	扭矩 Torque [N·m]	-	MC-DPAB5.08HXX-F-0001	4-48	MC-DPAB5.08VXX-I-0001	4-48
额定电压 Rated voltage [V]	320	固定螺钉 Fixed screw M2.5	MC-DPAB5.08HXX-G-0001	4-48			
硬导线截面积 Solid [mm²][AWG]	-	扭矩 Torque [N·m]	0.3	MC-DPAB5.08HXX-I-0001	4-48		
柔性导线截面积 Flexible [mm²][AWG]	-	剥线长度 Strip length [mm]	-	MC-DPAB5.08VXX-0001	4-48		
额定冲击电压 Rated impulse voltage [KV]	4			MC-DPAB5.08VXX-F-0001	4-48		

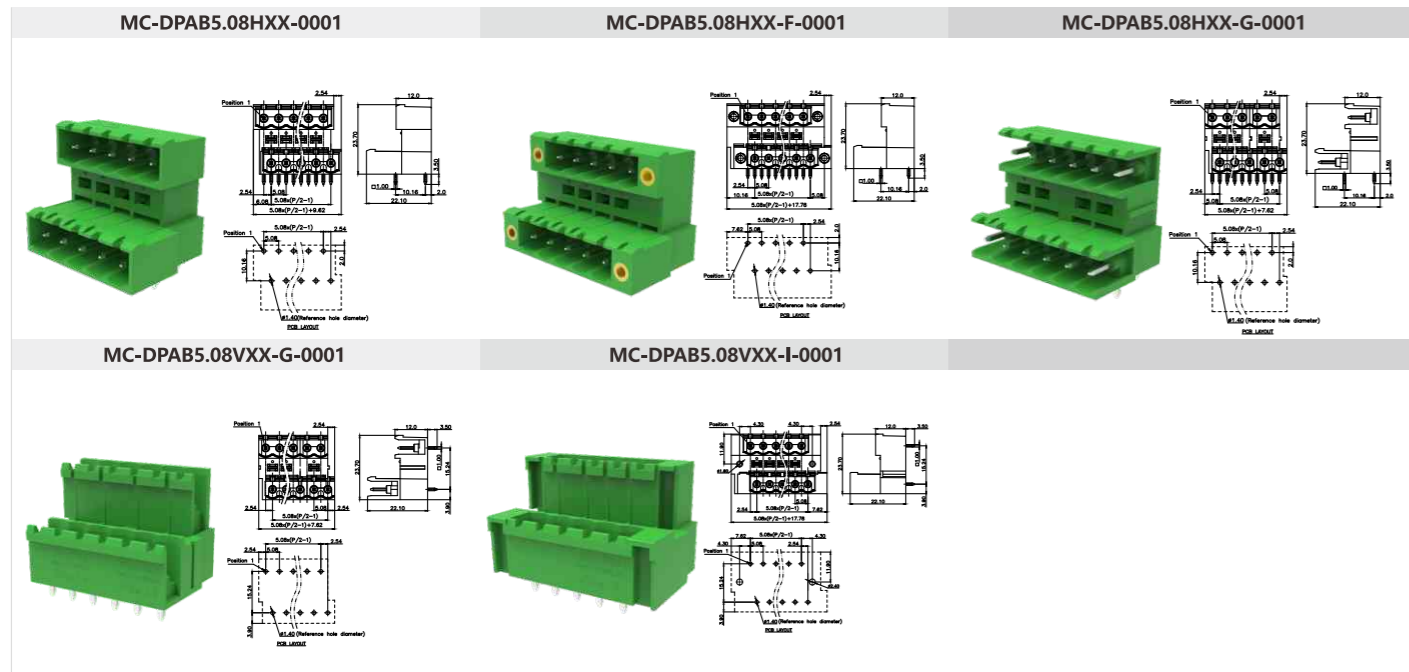

5.08mm间距 Pitch: 5.08mm

附件 Accessory	
MC-P-MSTB	

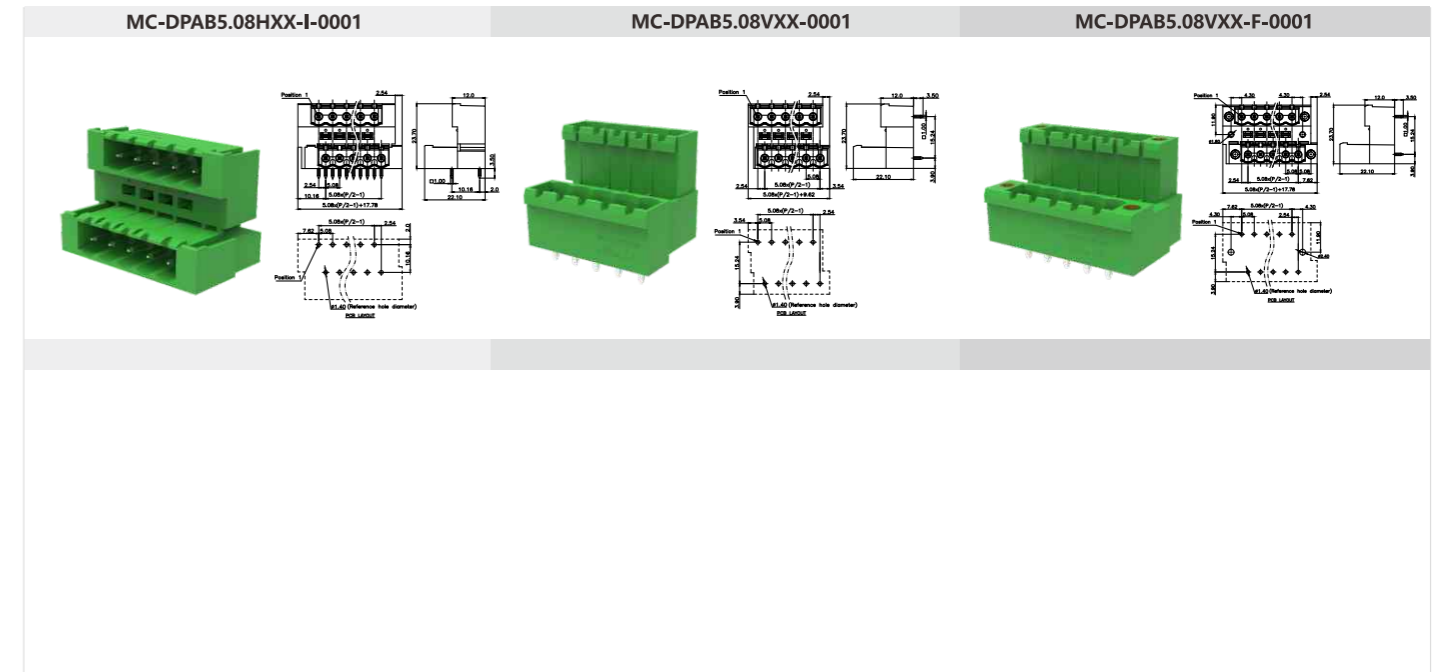

5.08mm间距 Pitch: 5.08mm

产品信息Product Information				产品信息Product Information				订货号/通道数 Order No./Poles No.		附件Accessory	
IEC/UL数据 IEC/UL Data	IEC	UL		锁线螺钉 Locking crew	-	MC-RU5.08SHXX-0001	2-24	MC-JP5.0-X			
额定电流 Rated current [A]	16	16		扭矩 Torque [N·m]	-	MC-RU5.08SHXX-F-0001	2-24	MC-R-MSTB			
额定电压 Rated voltage [V]	320	250		固定螺钉 Fixed screw	M2.5	MC-RU5.08SVXX-0001	2-24				
硬导线截面积 Solid [mm ²][AWG]	-	-		扭矩 Torque [N·m]	0.3	MC-RU5.08SVXX-F-0001	2-24				
柔性导线截面积 Flexible [mm ²][AWG]	-	-		剥线长度 Strip length [mm]	-						
额定冲击电压 Rated impulse voltage [KV]	4	-									

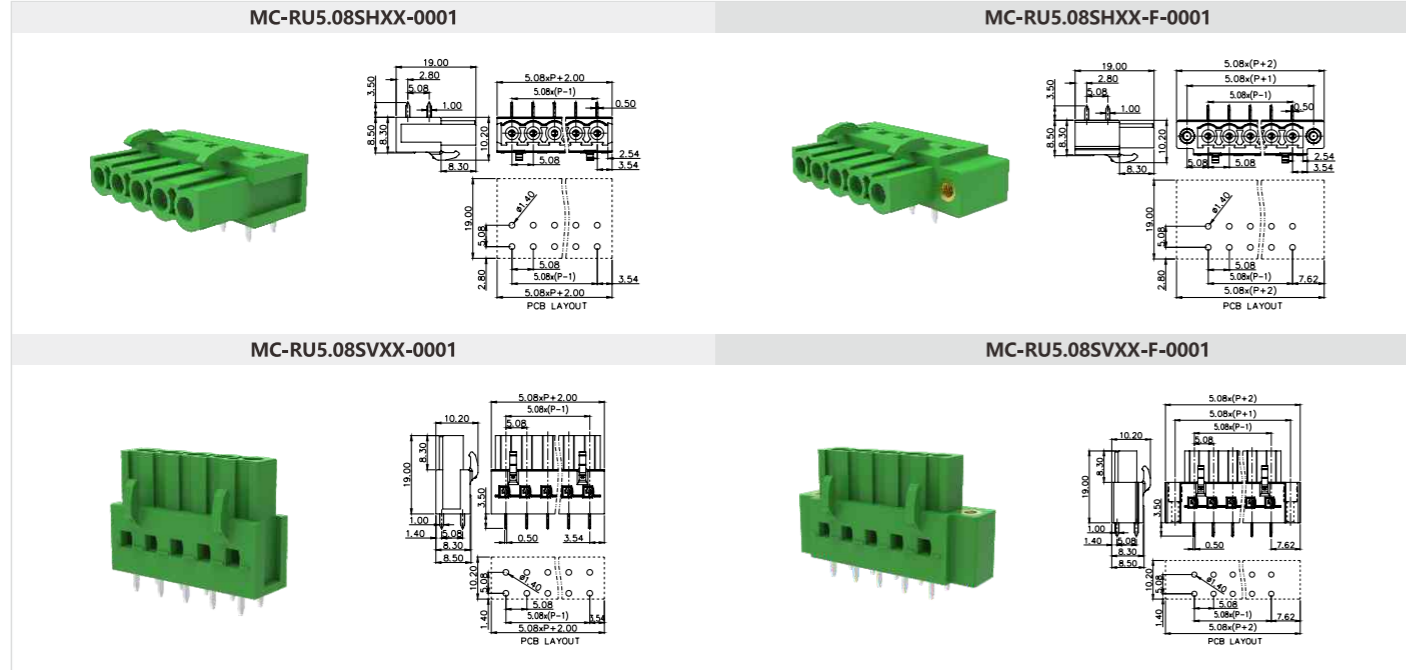

5.08mm间距 Pitch: 5.08mm

产品信息Product Information				产品信息Product Information				订货号/通道数 Order No./Poles No.		附件Accessory	
IEC/UL数据 IEC/UL Data	IEC	UL		锁线螺钉 Locking crew	M3	MC-RH5.08HXXC-B-0001	10-40	MC-JP5.0-X			
额定电流 Rated current [A]	12	15		扭矩 Torque [N·m]	0.5	MC-RH5.08HXXC-T-0001	10-40	MC-R-MSTB			
额定电压 Rated voltage [V]	320	300		固定螺钉 Fixed screw	-						
硬导线截面积 Solid [mm ²][AWG]	0.2-2.5	24-12		扭矩 Torque [N·m]	-						
柔性导线截面积 Flexible [mm ²][AWG]	0.2-2.5	24-12		剥线长度 Strip length [mm]	7-8						
额定冲击电压 Rated impulse voltage [KV]	4	-									

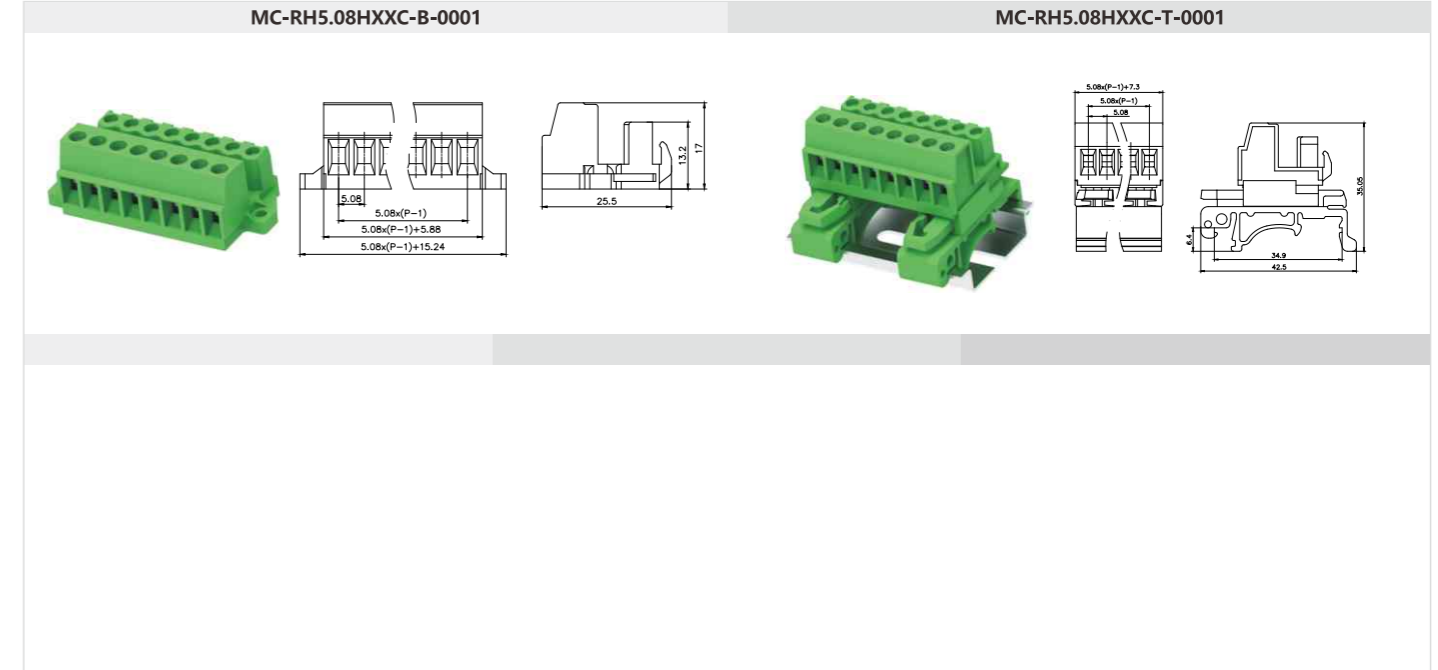

7.5mm间距 Pitch: 7.5mm

产品信息Product Information				产品信息Product Information				订货号/通道数 Order No./Poles No.		附件Accessory	
IEC/UL数据 IEC/UL Data	IEC	UL		锁线螺钉 Locking crew	M3	MC-RB7.5HXXC-0001	2-24				
额定电流 Rated current [A]	18	15		扭矩 Torque [N·m]	0.5	MC-RB7.5HXXC-K-0001	2-24				
额定电压 Rated voltage [V]	630	300		固定螺钉 Fixed screw	M2.5	MC-RB7.5HXXC-I-0001	2-24				
硬导线截面积 Solid [mm ²][AWG]	0.2-2.5	24-12		扭矩 Torque [N·m]	0.3						
柔性导线截面积 Flexible [mm ²][AWG]	0.2-2.5	24-12		剥线长度 Strip length [mm]	7-8						
额定冲击电压 Rated impulse voltage [KV]	4	-									

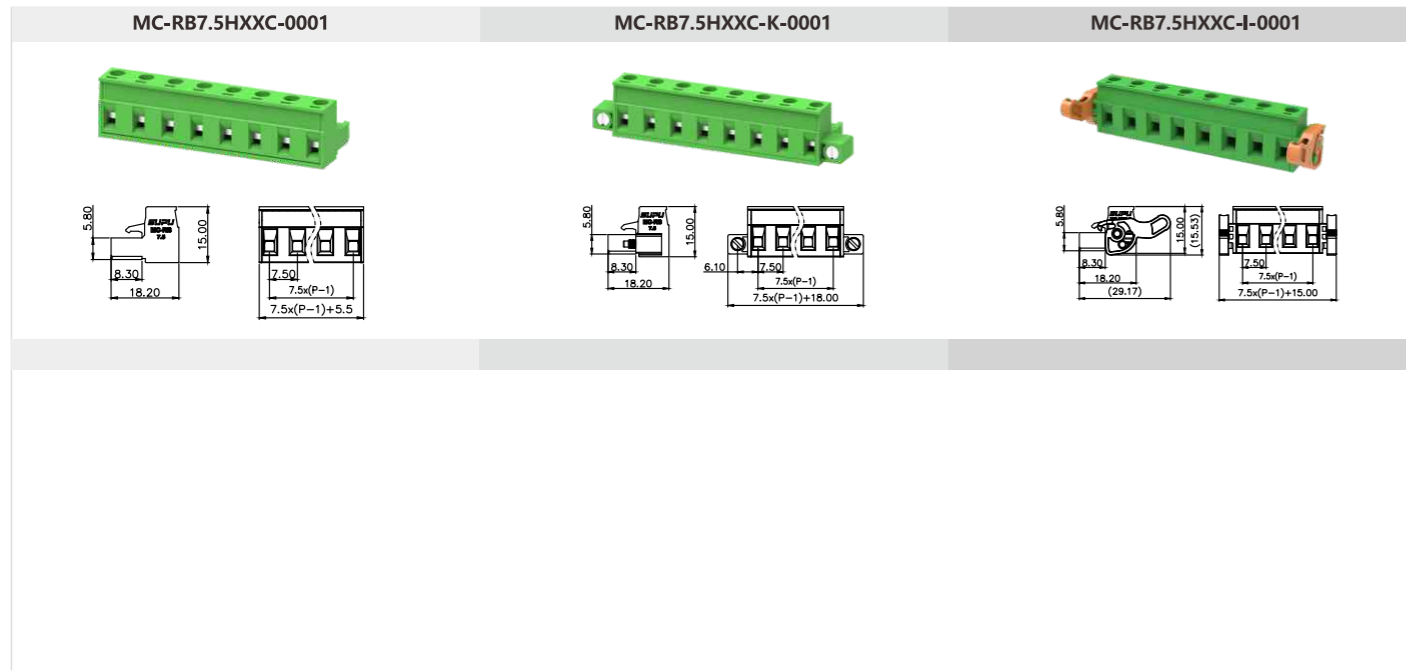

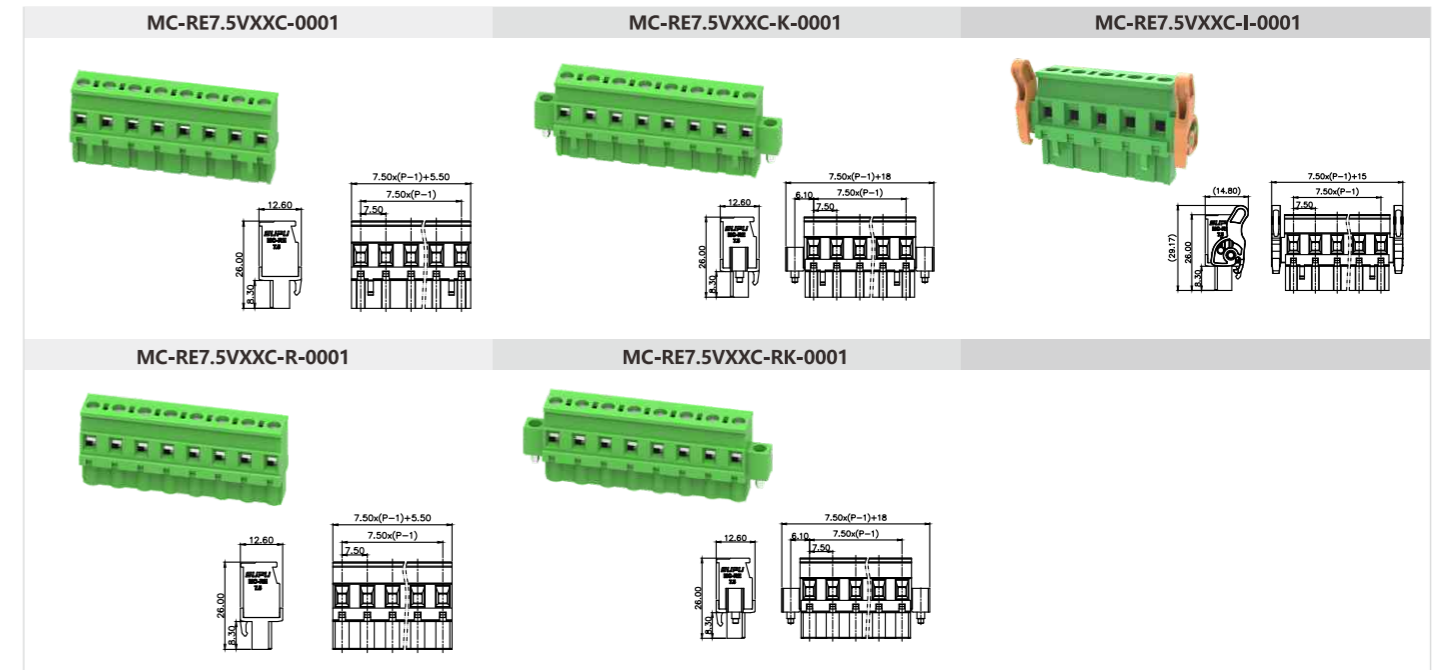

7.5mm间距 Pitch: 7.5mm

产品信息Product Information				产品信息Product Information				订货号/通道数 Order No./Poles No.		附件Accessory	
IEC/UL数据 IEC/UL Data	IEC	UL		锁线螺钉 Locking crew	M3	MC-RE7.5VXXC-0001	2-24				
额定电流 Rated current [A]	18	15		扭矩 Torque [N·m]	0.5	MC-RE7.5VXXC-K-0001	2-24				
额定电压 Rated voltage [V]	630	300		固定螺钉 Fixed screw	M2.5	MC-RE7.5VXXC-I-0001	2-24				
硬导线截面积 Solid [mm ²][AWG]	0.2-2.5	24-12		扭矩 Torque [N·m]	0.3	MC-RE7.5VXXC-R-0001	2-24				
柔性导线截面积 Flexible [mm ²][AWG]	0.2-2.5	24-12		剥线长度 Strip length [mm]	7-8	MC-RE7.5VXXC-RK-0001	2-24				
额定冲击电压 Rated impulse voltage [KV]	6	-									



7.5mm间距 Pitch: 7.5mm

产品信息 Product Information				锁线螺钉 Locking crew		订货号/通道数 Order No./Poles No.		附件 Accessory	
IEC/UL数据 IEC/UL Data	IEC	UL		-	MC-RJ7.5HXXP-0001	2-24			
额定电流 Rated current	[A]	12	10	扭矩 Torque [N·m]	-	MC-RJ7.5HXXP-K-0001	2-24		
额定电压 Rated voltage	[V]	630	300	固定螺钉 Fixed screw	M2.5	MC-RJ7.5HXXP-I-0001	2-24		
硬导线截面积 Solid [mm²][AWG]		0.2-2.5	24-12	扭矩 Torque [N·m]	0.3				
柔性导线截面积 Flexible [mm²][AWG]		0.2-2.5	24-12	剥线长度 Strip length [mm]	10-11				
额定冲击电压 Rated impulse voltage	[KV]	6	-						

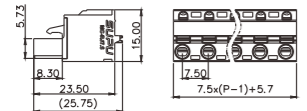
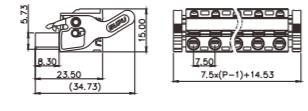
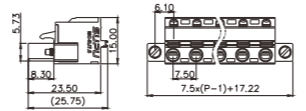
MC-RJ7.5HXXP-0001	MC-RJ7.5HXXP-K-0001	MC-RJ7.5HXXP-I-0001
		
		

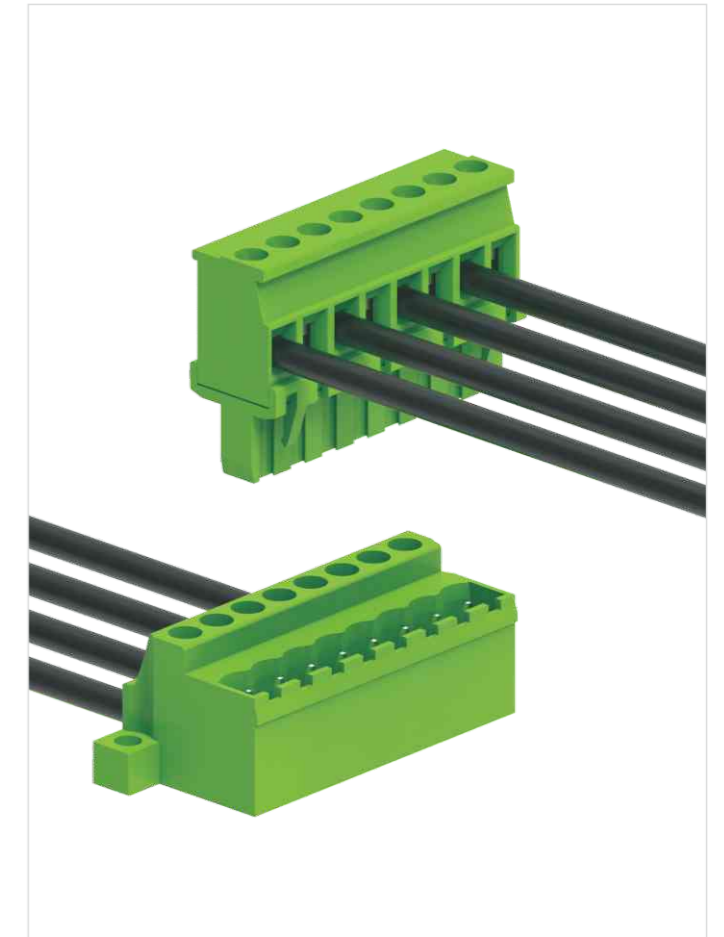
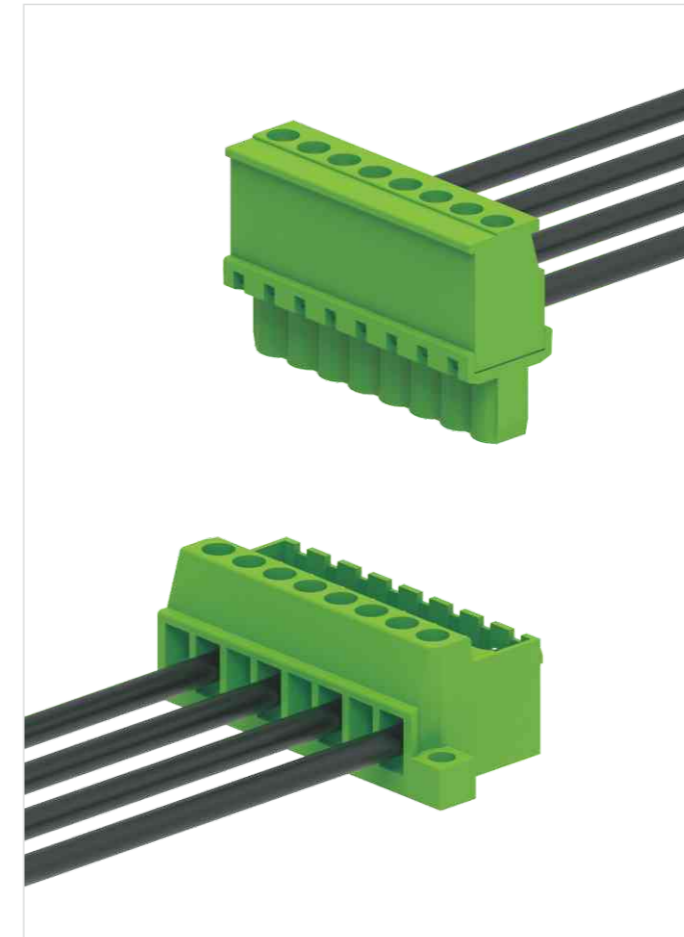

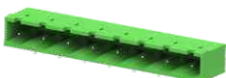
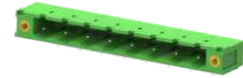
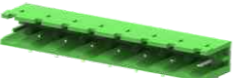
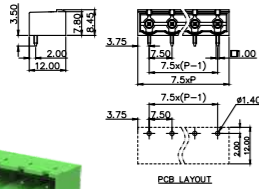
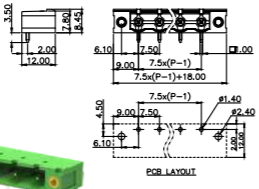
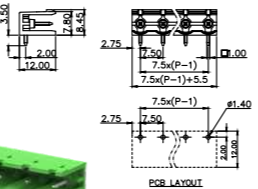
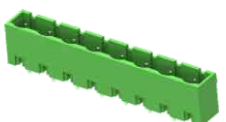
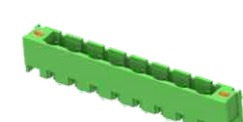
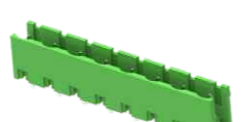
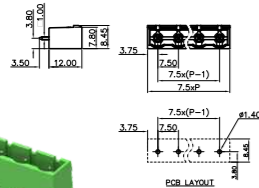
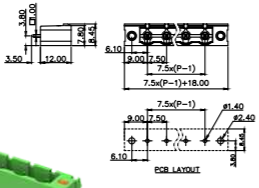
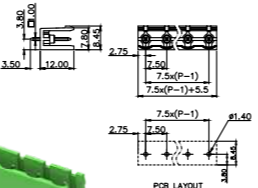

7.5mm间距 Pitch: 7.5mm

产品信息 Product Information				锁线螺钉 Locking crew		订货号/通道数 Order No./Poles No.		订货号/通道数 Order No./Poles No.		附件 Accessory	
IEC/UL数据 IEC/UL Data	IEC	UL		-	MC-PA7.5HXX-0002	2-24	MC-PA7.5VXX-0002	2-24			
额定电流 Rated current	[A]	18	15	扭矩 Torque [N·m]	-	MC-PA7.5HXX-F-0002	2-24	MC-PA7.5VXX-F-0002	2-24		
额定电压 Rated voltage	[V]	630	300	固定螺钉 Fixed screw	M2.5	MC-PA7.5HXX-G-0002	2-24	MC-PA7.5VXX-G-0002	2-24		
硬导线截面积 Solid [mm²][AWG]		-	-	扭矩 Torque [N·m]	0.3	MC-PA7.5HXX-I-0002	2-24	MC-PA7.5VXX-I-0002	2-24		
柔性导线截面积 Flexible [mm²][AWG]		-	-	剥线长度 Strip length [mm]	-						
额定冲击电压 Rated impulse voltage	[KV]	6	-								

MC-PA7.5HXX-0002	MC-PA7.5HXX-F-0002	MC-PA7.5HXX-G-0002
		
		
MC-PA7.5VXX-0002	MC-PA7.5VXX-F-0002	MC-PA7.5VXX-G-0002
		
		

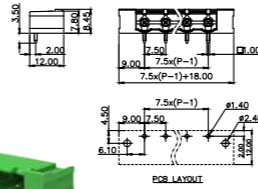
7.5mm间距 Pitch: 7.5mm

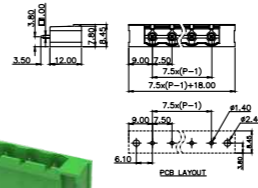
MC-PA7.5HXX-I-0002

MC-PA7.5VXX-I-0002

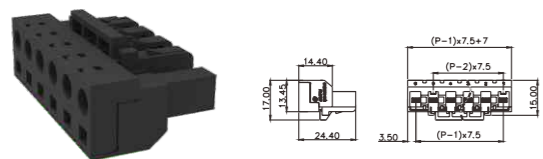

7.5mm间距 Pitch: 7.5mm

产品信息Product Information				锁线螺钉 Locking crew		订货号/通道数 Order No./Poles No.		附件Accessory	
IEC/UL数据 IEC/UL Data	IEC	UL		-					
额定电流 Rated current [A]	20	15			MC-ROX7.5HXXP-0001	2-12			
额定电压 Rated voltage [V]	630	300			MC-ROY7.5HXXP-0001	2-12			
硬导线截面积 Solid [mm ²][AWG]	0.2-2.5	24-12			MC-POX5.0HXX-0002	2-12			
柔性导线截面积 Flexible [mm ²][AWG]	0.2-2.5	24-12							
额定冲击电压 Rated impulse voltage [KV]	6	-							

MC-ROX7.5HXXP-0001



MC-ROY7.5HXXP-0001

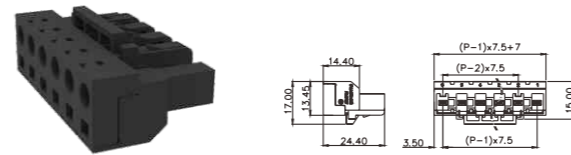

7.5mm间距 Pitch: 7.5mm

产品信息Product Information				锁线螺钉 Locking crew		订货号/通道数 Order No./Poles No.		附件Accessory	
IEC/UL数据 IEC/UL Data	IEC	UL		-					
额定电流 Rated current [A]	15	15			MC-POX7.5HXX-0001	2-12			
额定电压 Rated voltage [V]	630	300			MC-POY7.5HXX-0001	2-12			
硬导线截面积 Solid [mm ²][AWG]	-	-							
柔性导线截面积 Flexible [mm ²][AWG]	-	-							
额定冲击电压 Rated impulse voltage [KV]	6	-							

MC-POX7.5HXX-0001

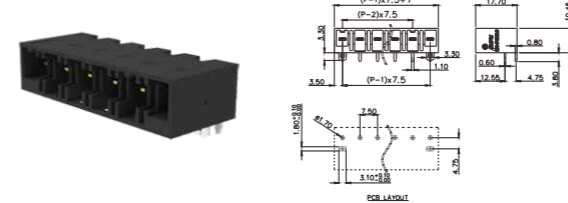

MC-POY7.5HXX-0001

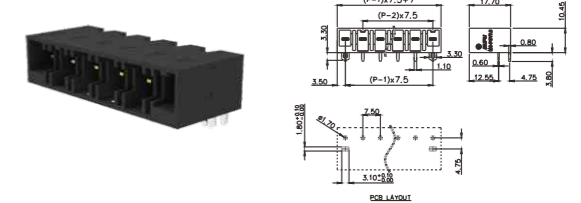

7.62mm间距 Pitch: 7.62mm

产品信息Product Information				锁线螺钉 Locking crew		订货号/通道数 Order No./Poles No.		附件Accessory	
IEC/UL数据 IEC/UL Data	IEC	UL		M3					
额定电流 Rated current [A]	18	15			MC-RB7.62HXXC-0001	2-24		MC-R-MSTB	
额定电压 Rated voltage [V]	630	300			MC-RB7.62HXX-K-0001	2-24			
硬导线截面积 Solid [mm ²][AWG]	0.2-2.5	28-12			MC-RB7.62HXX-I-0001	2-24			
柔性导线截面积 Flexible [mm ²][AWG]	0.2-2.5	28-12							
额定冲击电压 Rated impulse voltage [KV]	6	-							

7.62mm间距 Pitch: 7.62mm

产品信息Product Information				锁线螺钉 Locking crew		订货号/通道数 Order No./Poles No.		附件Accessory	
IEC/UL数据 IEC/UL Data	IEC	UL		M3					
额定电流 Rated current [A]	18	15			MC-RE7.62VXXC-0001	2-24		MC-R-MSTB	
额定电压 Rated voltage [V]	630	300			MC-RE7.62VXXC-K-0001	2-24			
硬导线截面积 Solid [mm ²][AWG]	0.2-2.5	30-12			MC-RE7.62VXXC-I-0001	2-24			
柔性导线截面积 Flexible [mm ²][AWG]	0.2-2.5	30-12			MC-RE7.62VXXC-RK-0001	2-24			
额定冲击电压 Rated impulse voltage [KV]	6	-							

MC-RB7.62HXXC-0001

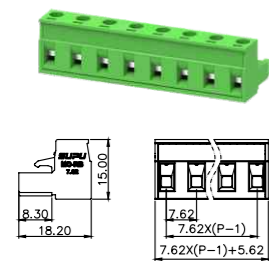

MC-RB7.62HXXC-K-0001

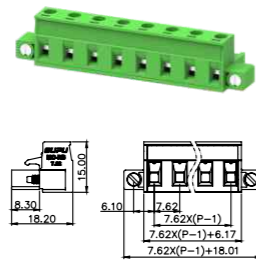

MC-RB7.62HXXC-I-0001

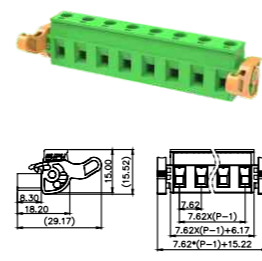

MC-RE7.62VXXC-0001

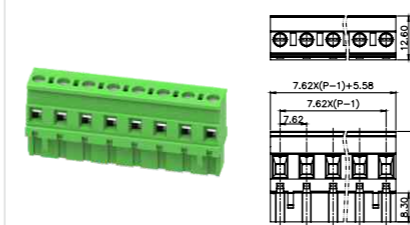

MC-RE7.62VXXC-K-0001

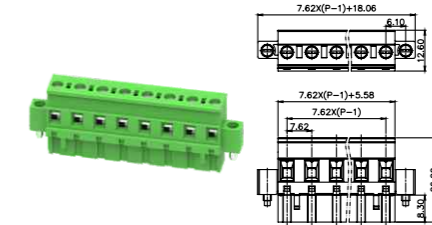

MC-RE7.62VXXC-I-0001

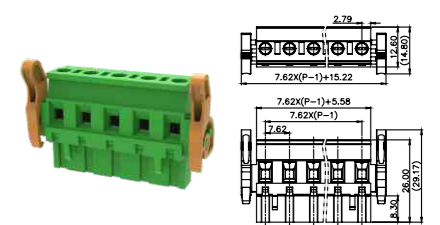

MC-RE7.62VXXC-R-0001

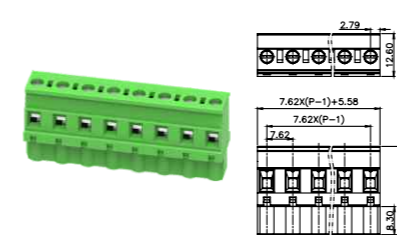

MC-RE7.62VXXC-RK-0001

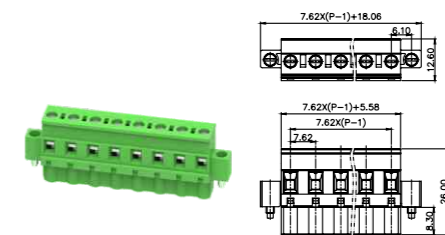

7.62mm间距 Pitch: 7.62mm

产品信息Product Information				产品信息Product Information		订货号/通道数 Order No./Poles No.		附件Accessory	
IEC/UL数据 IEC/UL Data	IEC	UL		锁线螺钉 Locking crew	-	MC-RJ7.62HXXP-0001	2-24	MC-R-MSTB	
额定电流 Rated current	[A]	12	10	扭矩 Torque	[N·m]	MC-RJ7.62HXXP-K-0001	2-24		
额定电压 Rated voltage	[V]	630	300	固定螺钉 Fixed screw	M2.5	MC-RJ7.62HXXP-I-0001	2-24		
硬导线截面积 Solid	[mm ²][AWG]	0.2-2.5	24-12	扭矩 Torque	[N·m]				
柔性导线截面积 Flexible	[mm ²][AWG]	0.2-2.5	24-12	剥线长度 Strip length	[mm]				
额定冲击电压 Rated impulse voltage	[KV]	6	-						

MC-RJ7.62HXXP-0001	MC-RJ7.62HXXP-K-0001	MC-RJ7.62HXXP-I-0001

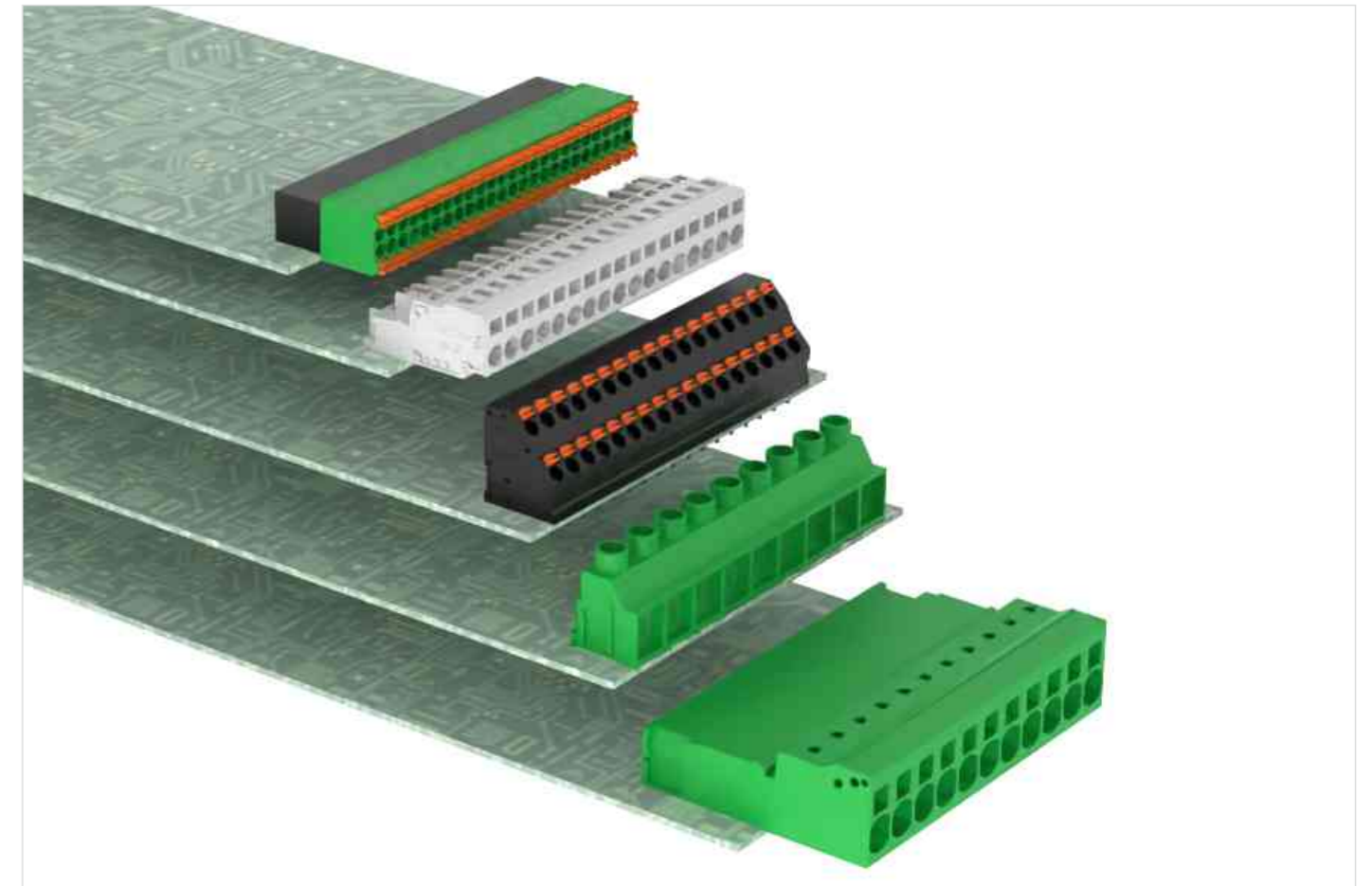

7.62mm间距 Pitch: 7.62mm

产品信息Product Information				产品信息Product Information		订货号/通道数 Order No./Poles No.		订货号/通道数 Order No./Poles No.	
IEC/UL数据 IEC/UL Data	IEC	UL		锁线螺钉 Locking crew	-	MC-PA7.62HXX-0002	2-24	MC-PA7.62VXX-0002	2-24
额定电流 Rated current	[A]	18	15	扭矩 Torque	[N·m]	MC-PA7.62HXX-F-0002	2-24	MC-PA7.62VXX-F-0002	2-24
额定电压 Rated voltage	[V]	630	300	固定螺钉 Fixed screw	M2.5	MC-PA7.62HXX-G-0002	2-24	MC-PA7.62VXX-G-0002	2-24
硬导线截面积 Solid	[mm ²][AWG]	-	-	扭矩 Torque	[N·m]	MC-PA7.62HXX-I-0002	2-24	MC-PA7.62VXX-I-0002	2-24
柔性导线截面积 Flexible	[mm ²][AWG]	-	-	剥线长度 Strip length	[mm]				
额定冲击电压 Rated impulse voltage	[KV]	6	-						

MC-PA7.62HXX-0002	MC-PA7.62HXX-F-0002	MC-PA7.62HXX-G-0002
MC-PA7.62VXX-0002	MC-PA7.62VXX-F-0002	MC-PA7.62VXX-G-0002

7.62mm间距 Pitch: 7.62mm

附件Accessory	
MC-P-MSTB	
MC-PA7.62HXX-I-0002	
MC-PA7.62VXX-I-0002	

7.62mm间距 Pitch: 7.62mm

产品信息Product Information			产品信息Product Information		订货号/通道数 Order No./Poles No.		订货号/通道数 Order No./Poles No.		
IEC/UL数据 IEC/UL Data	IEC	UL	锁线螺钉 Locking crew	M3	MC-PB7.62HXXC-0001	2-24	MC-PB7.62HXXC-B-0001	2-24	
额定电流 Rated current	[A]	12	10	扭矩 Torque [N·m]	0.5	MC-PB7.62HXXC-F-0001	2-24	MC-PB7.62HXXC-FB-0001	2-24
额定电压 Rated voltage	[V]	630	300	固定螺钉 Fixed screw	M2.5	MC-PB7.62HXXC-K-0001	2-24	MC-PB7.62HXXC-KB-0001	2-24
硬导线截面积 Solid [mm ²][AWG]	0.2-2.5	24-12	扭矩 Torque [N·m]	0.3	MC-PB7.62HXXC-I-0001	2-24	MC-PB7.62HXXC-IB-0001	2-24	
柔性导线截面积 Flexible [mm ²][AWG]	0.2-2.5	24-12	剥线长度 Strip length [mm]	7-8					
额定冲击电压 Rated impulse voltage [KV]	6	-							

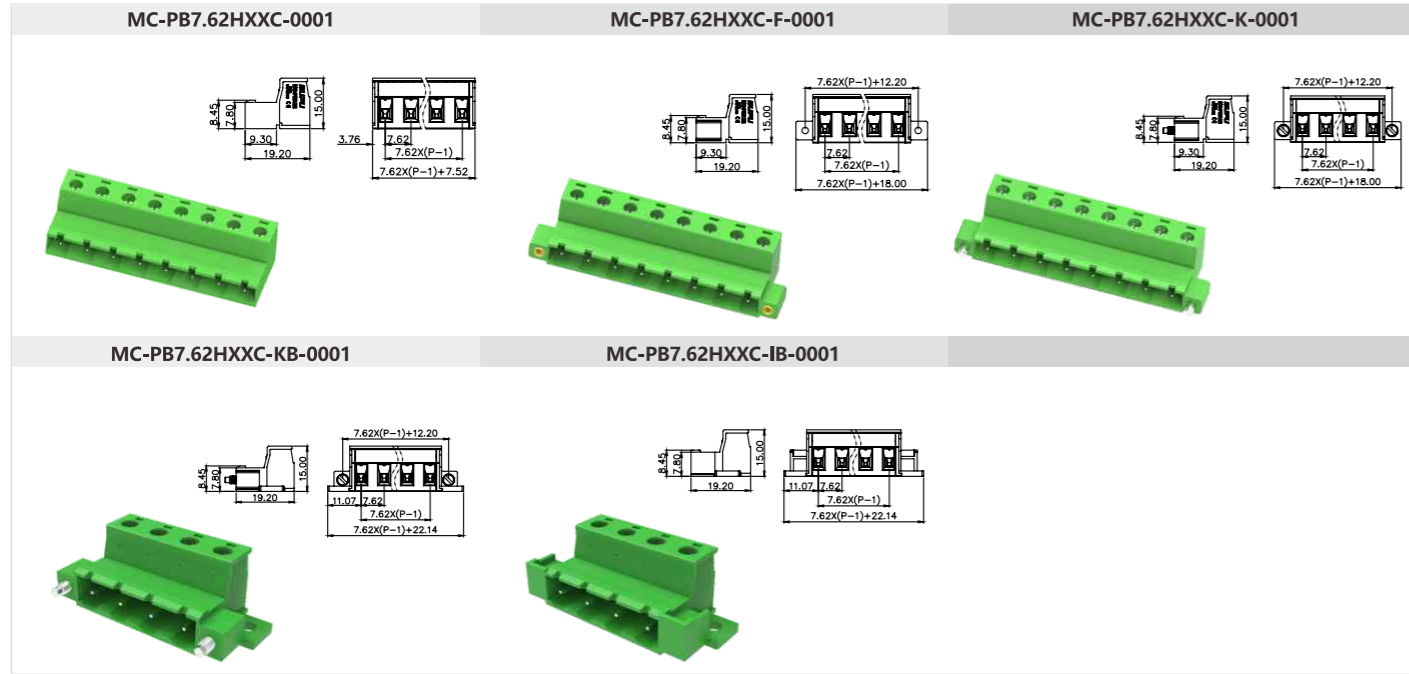

7.62mm间距 Pitch: 7.62mm

附件Accessory	
MC-P-MSTB	

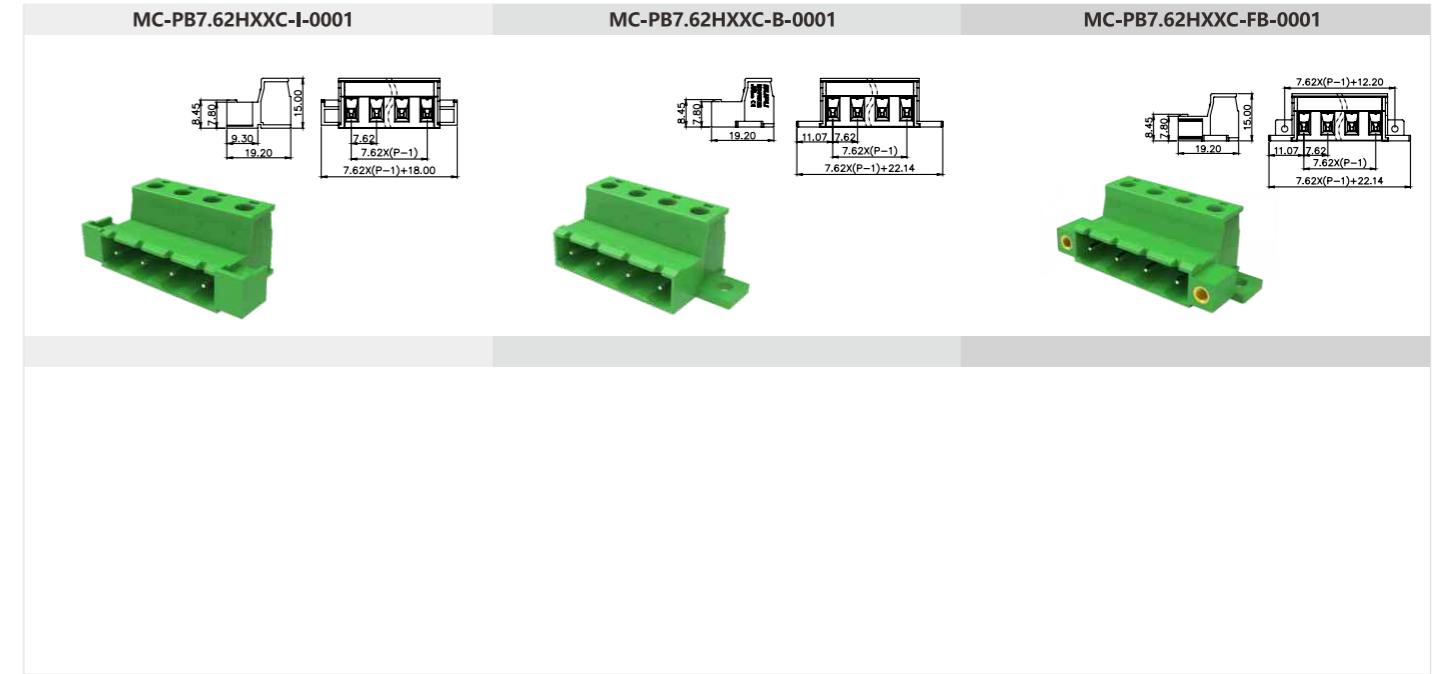

7.62mm间距 Pitch: 7.62mm

产品信息Product Information			产品信息Product Information		订货号/通道数 Order No./Poles No.		附件Accessory	
IEC/UL数据 IEC/UL Data	IEC	UL	锁线螺钉 Locking crew	M3	MC-RHH7.62HXXC-0001	2-12	MC-R-RH7.62	
额定电流 Rated current	[A]	41	41	扭矩 Torque [N·m]	0.5	MC-RHH7.62HXXC-K-0001	2-12	
额定电压 Rated voltage	[V]	1000	600	固定螺钉 Fixed screw	M3			
硬导线截面积 Solid [mm ²][AWG]	0.2-6.0	24-8	扭矩 Torque [N·m]	0.5				
柔性导线截面积 Flexible [mm ²][AWG]	0.2-6.0	24-8	剥线长度 Strip length [mm]	10-11				
额定冲击电压 Rated impulse voltage [KV]	8	-						

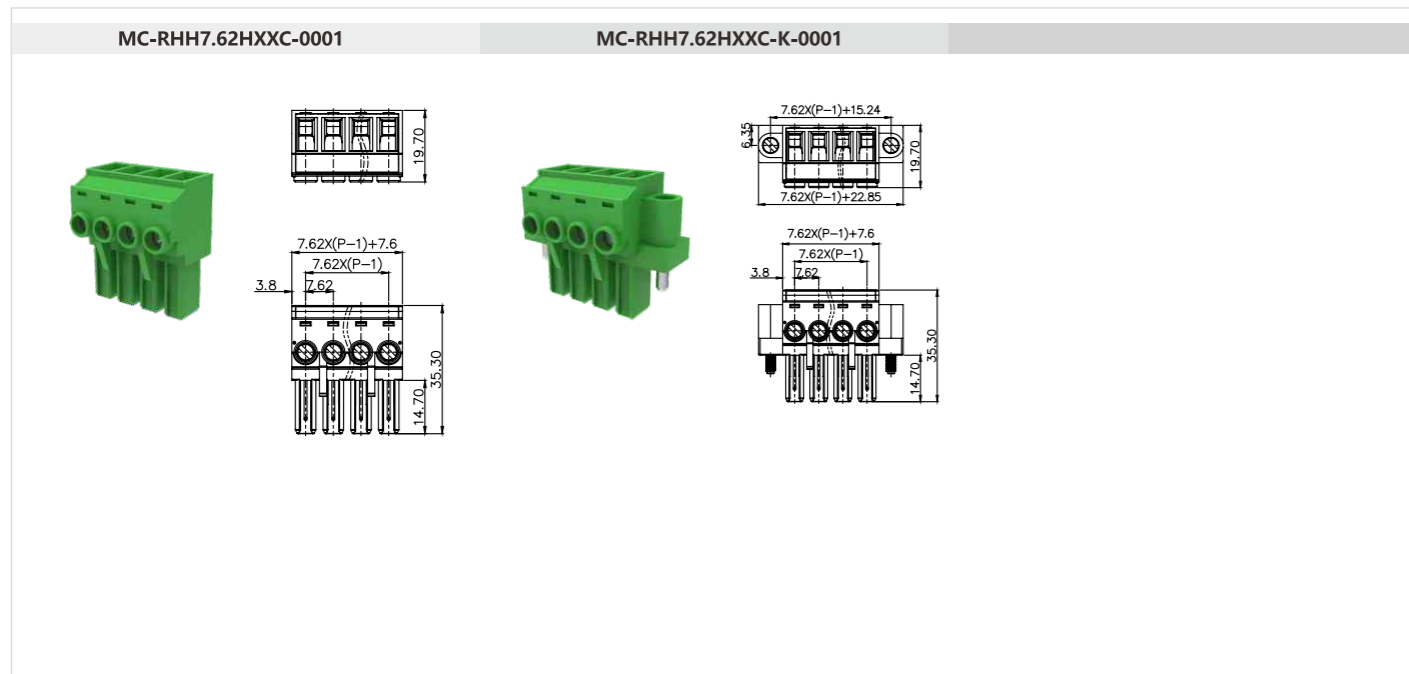

7.62mm间距 Pitch: 7.62mm

产品信息Product Information			产品信息Product Information		订货号/通道数 Order No./Poles No.		附件Accessory	
IEC/UL数据 IEC/UL Data	IEC	UL	锁线螺钉 Locking crew	M3	MC-RQ7.62HXXP-0001	1-16		
额定电流 Rated current	[A]	41	35	扭矩 Torque [N·m]	0.5	MC-RQ7.62HXXP-K-0001	1-16	
额定电压 Rated voltage	[V]	1000	600	固定螺钉 Fixed screw	M3			
硬导线截面积 Solid [mm ²][AWG]	0.2-10	24-8	扭矩 Torque [N·m]	4.43				
柔性导线截面积 Flexible [mm ²][AWG]	0.2-6	24-8	剥线长度 Strip length [mm]	13-15				
额定冲击电压 Rated impulse voltage [KV]	8	-						

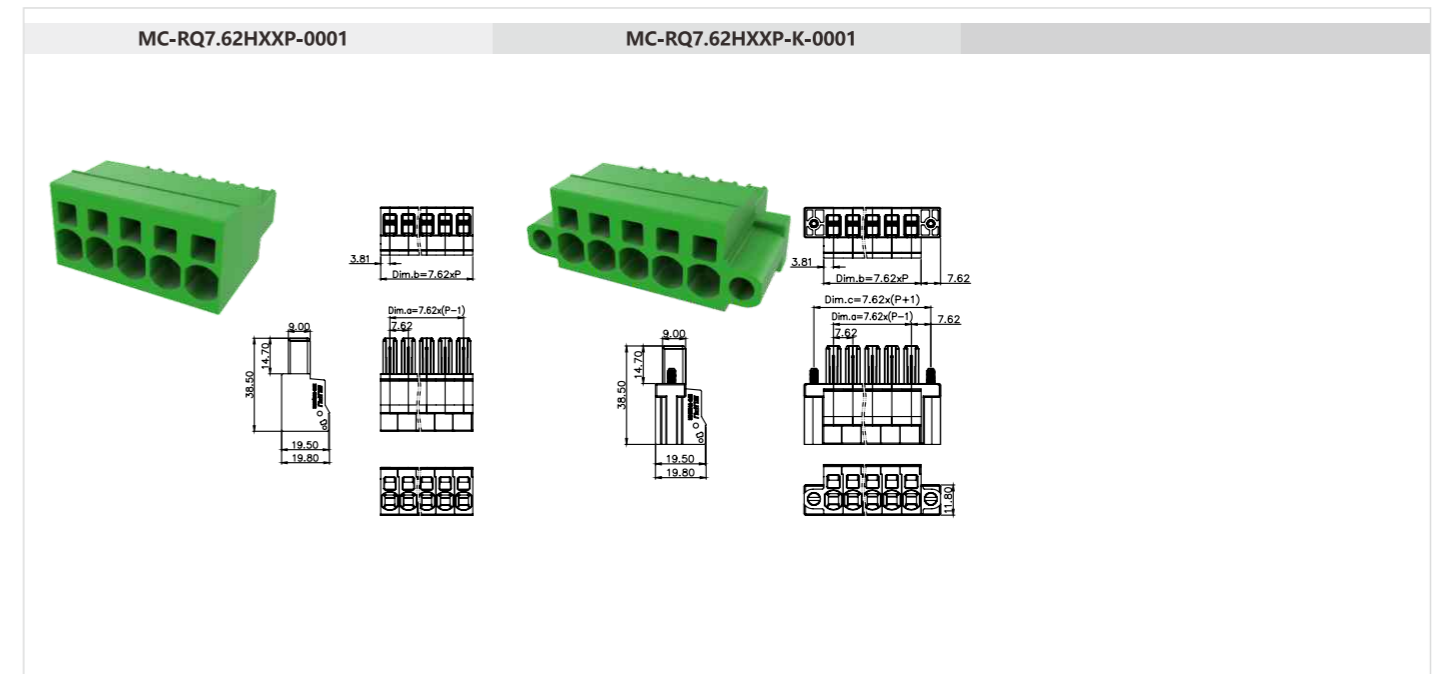

7.62mm间距 Pitch: 7.62mm

产品信息Product Information				产品信息Product Information				订货号/通道数 Order No./Poles No.		附件Accessory	
IEC/UL数据 IEC/UL Data	IEC	UL	锁线螺钉 Locking crew	-	MC-PH7.62HXX-0001	2-12	MC-R-RH7.62				
额定电流 Rated current	[A]	20	20	扭矩 Torque [N·m]	-	MC-PH7.62HXX-F-0001	2-12				
额定电压 Rated voltage	[V]	630	300	固定螺钉 Fixed screw	M3	MC-PH7.62VXX-0001	2-12				
硬导线截面积 Solid [mm ²][AWG]	-	-	-	扭矩 Torque [N·m]	0.5	MC-PH7.62VXX-F-0001	2-12				
柔性导线截面积 Flexible [mm ²][AWG]	-	-	-	剥线长度 Strip length [mm]	-						
额定冲击电压 Rated impulse voltage	[KV]	6	-								

MC-PH7.62HXX-0001

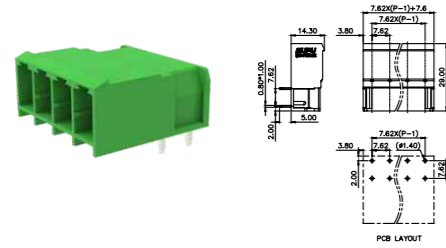

MC-PH7.62HXX-F-0001

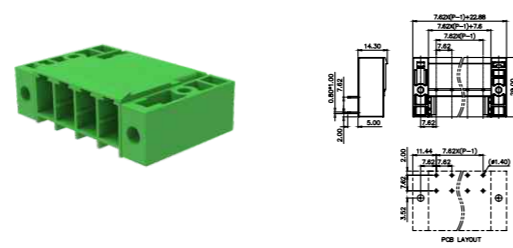

MC-PH7.62VXX-0001

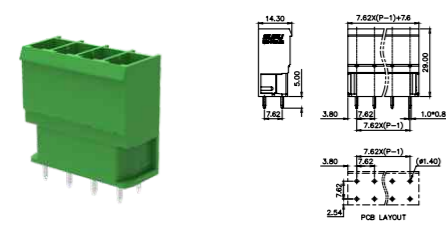

MC-PH7.62VXX-F-0001

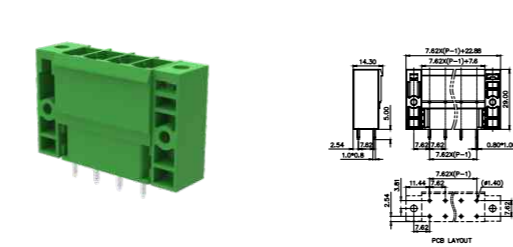

7.62mm间距 Pitch: 7.62mm

产品信息Product Information				产品信息Product Information				订货号/通道数 Order No./Poles No.		附件Accessory	
IEC/UL数据 IEC/UL Data	IEC	UL	锁线螺钉 Locking crew	-	MC-RH7.62HXX-0001	2-12	MC-R-RH7.62				
额定电流 Rated current	[A]	20	20	扭矩 Torque [N·m]	-	MC-RH7.62HXX-K-0001	2-12				
额定电压 Rated voltage	[V]	630	300	固定螺钉 Fixed screw	M3						
硬导线截面积 Solid [mm ²][AWG]	0.2-4.0	-	-	扭矩 Torque [N·m]	0.5						
柔性导线截面积 Flexible [mm ²][AWG]	0.2-4.0	-	-	剥线长度 Strip length [mm]	10-11						
额定冲击电压 Rated impulse voltage	[KV]	6	-								

MC-RH7.62HXX-0001

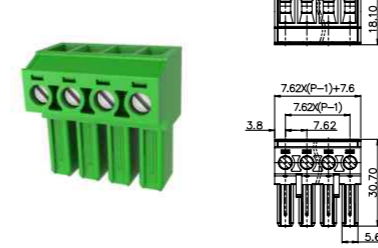

MC-RH7.62HXX-K-0001

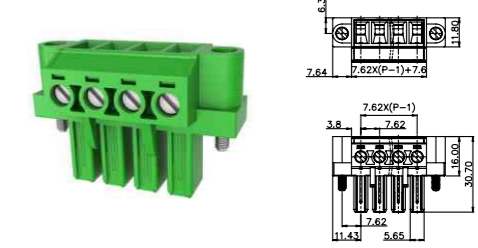

7.62mm间距 Pitch: 7.62mm

产品信息Product Information				产品信息Product Information				订货号/通道数 Order /Poles No.		订货号/通道数 Order /Poles No.	
IEC/UL数据 IEC/UL Data	IEC	UL	锁线螺钉 Locking crew	-	MC-PHH7.62HXX-0001	2-12	MC-PHH7.62VXX-0001	2-12			
额定电流 Rated current	[A]	41	41	扭矩 Torque [N·m]	-	MC-PHH7.62HXX-I-0001	2-12	MC-PHH7.62VXX-I-0001	2-12		
额定电压 Rated voltage	[V]	630	300	固定螺钉 Fixed screw	M3	MC-PHH7.62HXX-F-0001	2-12	MC-PHH7.62VXX-F-0001	2-12		
硬导线截面积 Solid [mm ²][AWG]	-	-	-	扭矩 Torque [N·m]	0.5	MC-PHH7.62HXX-F-0030	2-12	MC-PHH7.62VXX-F-0030	2-12		
柔性导线截面积 Flexible [mm ²][AWG]	-	-	-	剥线长度 Strip length [mm]	-						
额定冲击电压 Rated impulse voltage	[KV]	6	-								

MC-PHH7.62HXX-0001

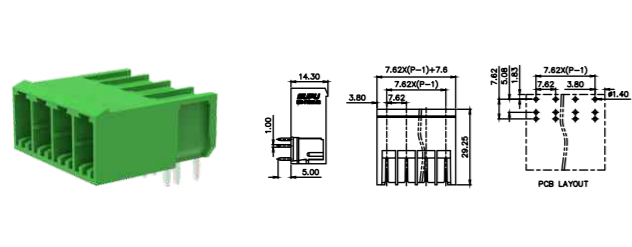

MC-PHH7.62HXX-I-0001

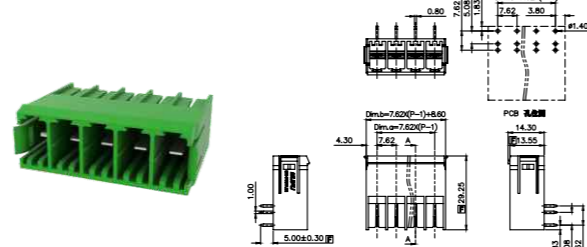

MC-PHH7.62VXX-0001

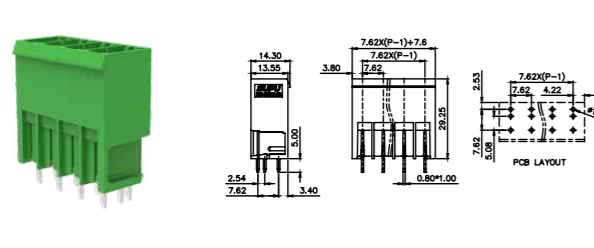

MC-PHH7.62VXX-I-0001

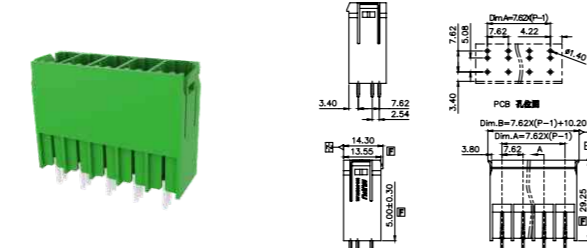

7.62mm间距 Pitch: 7.62mm

附件Accessory	
MC-R-RH7.62	

MC-PHH7.62HXX-F-0001

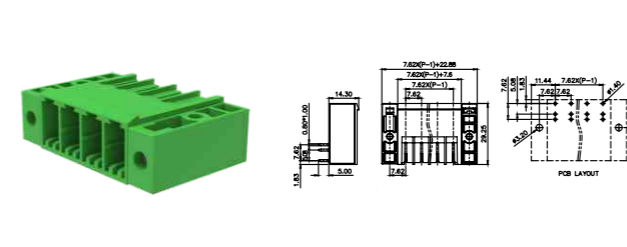

MC-PHH7.62HXX-F-0030

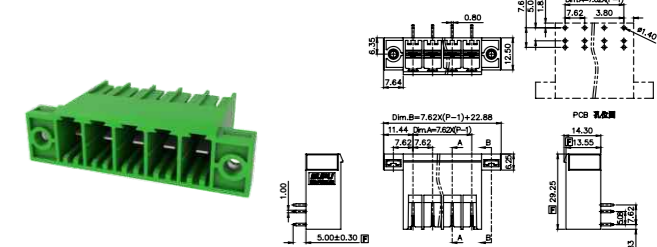

MC-PHH7.62VXX-F-0001

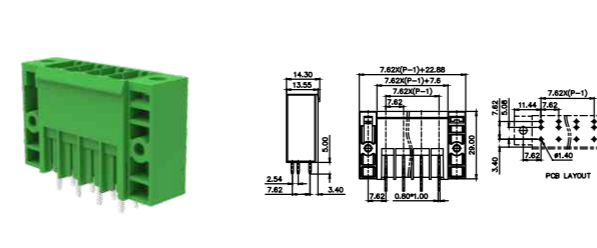

MC-PHH7.62VXX-F-0030

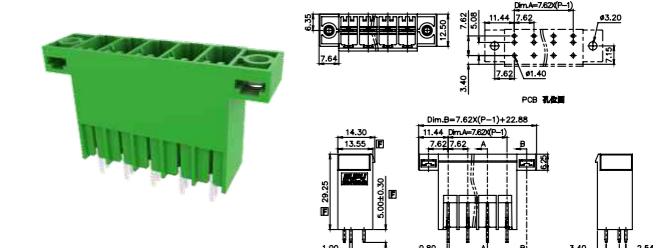

10.16mm间距 Pitch: 10.16mm

产品信息Product Information		产品信息Product Information		锁线螺钉 Locking crew		订货号/通道数 Order No./Poles No.		附件Accessory	
IEC/UL数据 IEC/UL Data		IEC	UL	锁线螺钉 Locking crew	M4	MC-RHH10.16HXXC-0001	2-12		
额定电流 Rated current	[A]	76	55	扭矩 Torque	[N·m]	MC-RHH10.16HXXC-K-0001	2-12		
额定电压 Rated voltage	[V]	1000	600	固定螺钉 Fixed screw	M3				
硬导线截面积 Solid	[mm ²][AWG]	0.5-16	20-6	扭矩 Torque	[N·m]				
柔性导线截面积 Flexible	[mm ²][AWG]	0.5-16	20-6	剥线长度 Strip length	[mm]				
额定冲击电压 Rated impulse voltage	[KV]	8	-						

MC-RHH10.16HXXC-0001

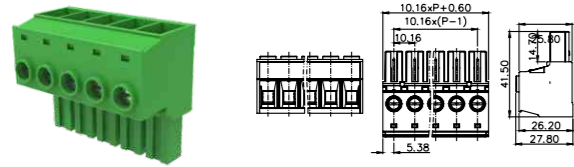

MC-RHH10.16HXXC-K-0001

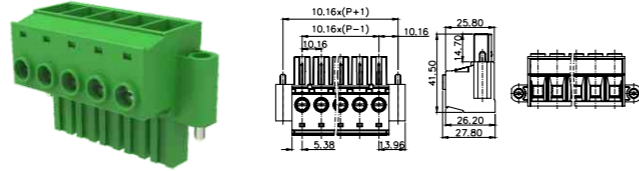

10.16mm间距 Pitch: 10.16mm

产品信息Product Information		产品信息Product Information		订货号/通道数 Order /Poles No.		附件Accessory	
IEC/UL数据 IEC/UL Data		IEC	UL	锁线螺钉 Locking crew	-	MC-PH10.16HXX-0001	2-12
额定电流 Rated current	[A]	76	66	扭矩 Torque	[N·m]	MC-PH10.16HXX-F-0001	2-12
额定电压 Rated voltage	[V]	1000	300	固定螺钉 Fixed screw	M3	MC-PH10.16VXX-0001	2-12
硬导线截面积 Solid	[mm ²][AWG]	-	-	扭矩 Torque	[N·m]	MC-PH10.16VXX-F-0001	2-12
柔性导线截面积 Flexible	[mm ²][AWG]	-	-	剥线长度 Strip length	[mm]		
额定冲击电压 Rated impulse voltage	[KV]	8	-				

MC-PH10.16HXX-0001

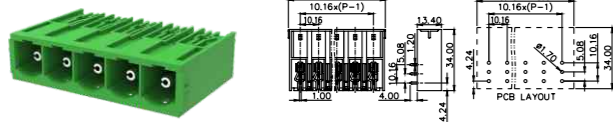

MC-PH10.16HXX-F-0001

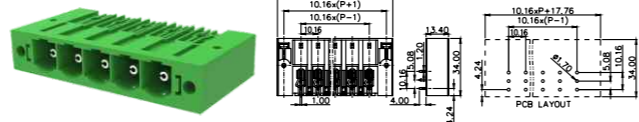

MC-PH10.16VXX-0001

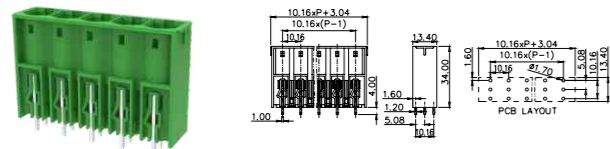

MC-PH10.16VXX-F-0001

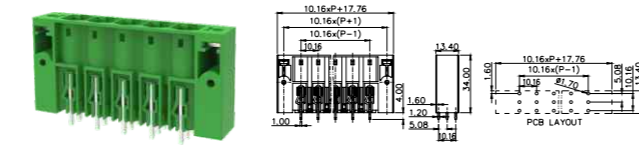

3.5mm间距 Pitch: 3.5mm

产品信息Product Information		产品信息Product Information		锁线螺钉 Locking crew		订货号/通道数 Order No./Poles No.		附件Accessory	
IEC/UL数据 IEC/UL Data		IEC	UL	锁线螺钉 Locking crew	-	MC-TI3.5HXXP-BK-0001	2-24		
额定电流 Rated current	[A]	17.5	12	扭矩 Torque	[N·m]	MC-TI3.5HXXP-BK-1600	2-24		
额定电压 Rated voltage	[V]	200	300	固定螺钉 Fixed screw	-	MC-TI3.5VXXP-BK-0001	2-24		
硬导线截面积 Solid	[mm ²][AWG]	0.2-1.5	28-14	扭矩 Torque	[N·m]	MC-TI3.5VXXP-BK-1600	2-24		
柔性导线截面积 Flexible	[mm ²][AWG]	0.2-1.5	28-14	剥线长度 Strip length	[mm]				
额定冲击电压 Rated impulse voltage	[KV]	2.5	-						

MC-TI3.5HXXP-BK-0001

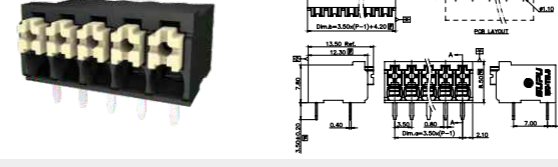

MC-TI3.5HXXP-BK-1600

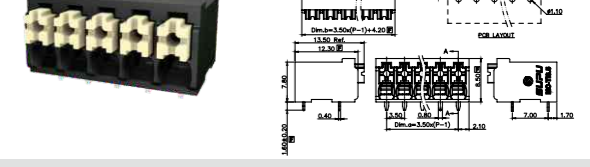

MC-TI3.5VXXP-BK-0001

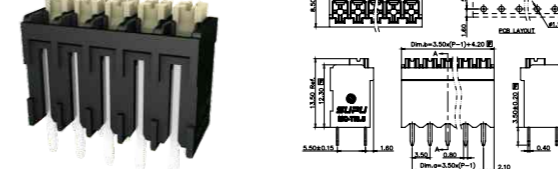

MC-TI3.5VXXP-BK-1600

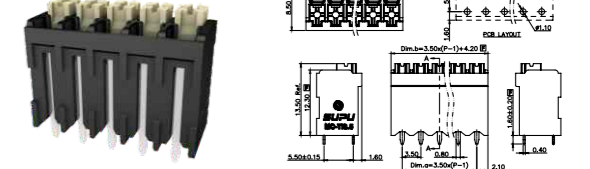

3.5mm间距 Pitch: 3.5mm

产品信息Product Information		产品信息Product Information		订货号/通道数 Order /Poles No.		附件Accessory	
IEC/UL数据 IEC/UL Data		IEC	UL	锁线螺钉 Locking crew	-	MC-TI3.5HXXP-BK-0001-SMT	2-24
额定电流 Rated current	[A]	17.5	10	扭矩 Torque	[N·m]	MC-TI3.5VXXP-BK-0001-SMT	2-24
额定电压 Rated voltage	[V]	160	300	固定螺钉 Fixed screw	-		
硬导线截面积 Solid	[mm ²][AWG]	0.2-1.5	24-16	扭矩 Torque	[N·m]		
柔性导线截面积 Flexible	[mm ²][AWG]	0.2-1.5	24-16	剥线长度 Strip length	[mm]		
额定冲击电压 Rated impulse voltage	[KV]	2.5	-				

MC-TI3.5HXXP-BK-0001-SMT

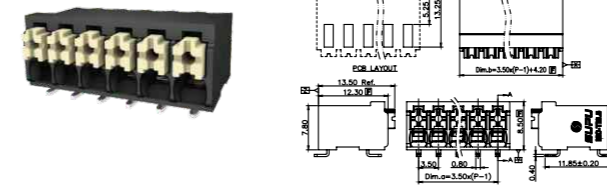

MC-TI3.5VXXP-BK-0001-SMT

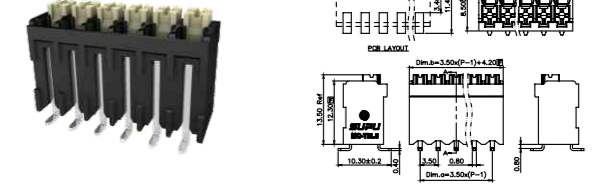

3.81mm间距 Pitch: 3.81mm

产品信息Product Information		产品信息Product Information		锁线螺钉 Locking crew		订货号/通道数 Order /Poles No.	
IEC/UL数据 IEC/UL Data		IEC	UL	锁线螺钉 Locking crew	M2	MC-TM3.81HXXC-0001	2-24
额定电流 Rated current	[A]	8	10	扭矩 Torque	[N·m]		
额定电压 Rated voltage	[V]	160	300	固定螺钉 Fixed screw	-		
硬导线截面积 Solid	[mm ²][AWG]	0.2-1.5	24-16	扭矩 Torque	[N·m]		
柔性导线截面积 Flexible	[mm ²][AWG]	0.2-1.5	24-16	剥线长度 Strip length	[mm]		
额定冲击电压 Rated impulse voltage	[KV]	2.5	-				

订货号/通道数 Order /Poles No.	附件Accessory
MC-TM3.81HXXC-0001	2-24

MC-TM3.81HXXC-0001

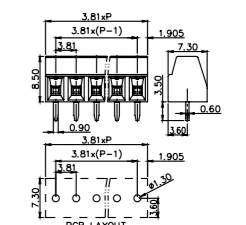

3.81mm间距 Pitch: 3.81mm

MC-DTM3.81HXXC-0001

产品信息 Product Information		产品信息 Product Information	
IEC/UL数据 IEC/UL Data	IEC UL	锁线螺钉 Locking crew	M2
额定电流 Rated current [A]	8 10	扭矩 Torque [N·m]	0.2
额定电压 Rated voltage [V]	160 300	固定螺钉 Fixed screw	-
硬导线截面积 Solid [mm²][AWG]	0.2-1.5 24-16	扭矩 Torque [N·m]	-
柔性导线截面积 Flexible [mm²][AWG]	0.2-1.5 24-16	剥线长度 Strip length [mm]	5
额定冲击电压 Rated impulse voltage [KV]	2.5 -		
订货号/通道数 Order No./Poles No.		附件 Accessory	
MC-DTM3.81HXXC-0001	2-24		

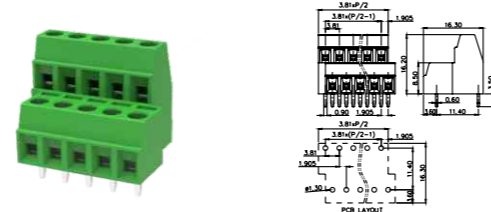

3.81mm间距 Pitch: 3.81mm

MC-TTM3.81HXXC-0001

产品信息 Product Information		产品信息 Product Information	
IEC/UL数据 IEC/UL Data	IEC UL	锁线螺钉 Locking crew	M2
额定电流 Rated current [A]	8 10	扭矩 Torque [N·m]	0.2
额定电压 Rated voltage [V]	160 300	固定螺钉 Fixed screw	-
硬导线截面积 Solid [mm²][AWG]	0.2-1.5 24-16	扭矩 Torque [N·m]	-
柔性导线截面积 Flexible [mm²][AWG]	0.2-1.5 24-16	剥线长度 Strip length [mm]	5
额定冲击电压 Rated impulse voltage [KV]	2.5 -		
订货号/通道数 Order No./Poles No.		附件 Accessory	
MC-TTM3.81HXXC-0001	2-24		

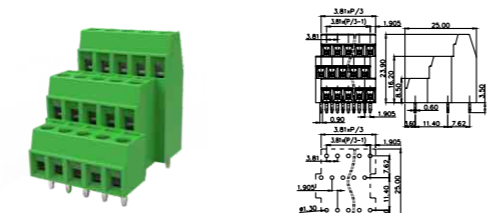

3.81mm间距 Pitch: 3.81mm

MC-TM3.81BXXC-0001

产品信息 Product Information		产品信息 Product Information	
IEC/UL数据 IEC/UL Data	IEC UL	锁线螺钉 Locking crew	M2
额定电流 Rated current [A]	10 10	扭矩 Torque [N·m]	0.2
额定电压 Rated voltage [V]	200 300	固定螺钉 Fixed screw	-
硬导线截面积 Solid [mm²][AWG]	0.2-1.5 24-16	扭矩 Torque [N·m]	-
柔性导线截面积 Flexible [mm²][AWG]	0.2-1.0 24-16	剥线长度 Strip length [mm]	4-5
额定冲击电压 Rated impulse voltage [KV]	2.5 -		
订货号/通道数 Order No./Poles No.		附件 Accessory	
MC-TM3.81BXXC-0001	2P-12P		

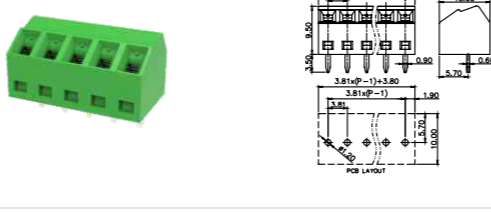

3.81mm间距 Pitch: 3.81mm

MC-TE3.81HXXC-0001

产品信息 Product Information		产品信息 Product Information	
IEC/UL数据 IEC/UL Data	IEC UL	锁线螺钉 Locking crew	M2
额定电流 Rated current [A]	12 12	扭矩 Torque [N·m]	0.2
额定电压 Rated voltage [V]	160 300	固定螺钉 Fixed screw	-
硬导线截面积 Solid [mm²][AWG]	0.2-1.5 24-16	扭矩 Torque [N·m]	-
柔性导线截面积 Flexible [mm²][AWG]	0.2-1.5 24-16	剥线长度 Strip length [mm]	5-6
额定冲击电压 Rated impulse voltage [KV]	2.5 -		
订货号/通道数 Order No./Poles No.		附件 Accessory	
MC-TE3.81HXXC-0001	2-24		

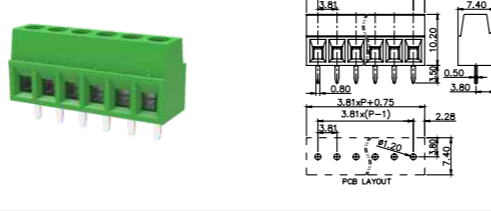

3.81mm间距 Pitch: 3.81mm

MC-TEH3.81HXXC-0001

产品信息 Product Information		产品信息 Product Information	
IEC/UL数据 IEC/UL Data	IEC UL	锁线螺钉 Locking crew	M2
额定电流 Rated current [A]	12 12	扭矩 Torque [N·m]	0.2
额定电压 Rated voltage [V]	160 300	固定螺钉 Fixed screw	-
硬导线截面积 Solid [mm²][AWG]	0.2-1.5 24-16	扭矩 Torque [N·m]	-
柔性导线截面积 Flexible [mm²][AWG]	0.2-1.5 24-16	剥线长度 Strip length [mm]	5-6
额定冲击电压 Rated impulse voltage [KV]	2.5 -		
订货号/通道数 Order No./Poles No.		附件 Accessory	
MC-TEH3.81HXXC-0001	2-24		

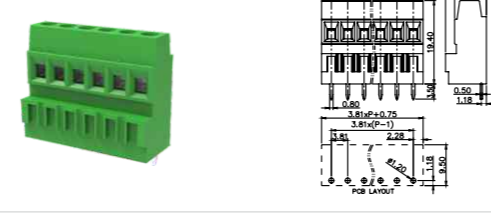

3.81mm间距 Pitch: 3.81mm

MC-DTEH3.81HXXC-0001

产品信息 Product Information		产品信息 Product Information	
IEC/UL数据 IEC/UL Data	IEC UL	锁线螺钉 Locking crew	M2
额定电流 Rated current [A]	12 12	扭矩 Torque [N·m]	0.2
额定电压 Rated voltage [V]	160 300	固定螺钉 Fixed screw	-
硬导线截面积 Solid [mm²][AWG]	0.2-1.5 24-16	扭矩 Torque [N·m]	-
柔性导线截面积 Flexible [mm²][AWG]	0.2-1.5 24-16	剥线长度 Strip length [mm]	5-6
额定冲击电压 Rated impulse voltage [KV]	2.5 -		
订货号/通道数 Order No./Poles No.		附件 Accessory	
MC-DTEH3.81HXXC-0001	2-24		

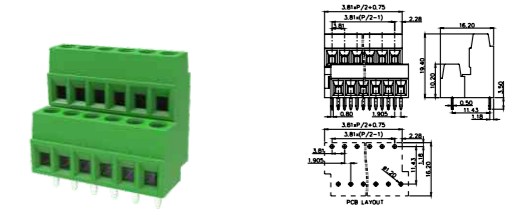

5.0mm间距 Pitch: 5.0mm

产品信息 Product Information		产品信息 Product Information		订货号/通道数 Order No./Poles No.	附件 Accessory
IEC/UL数据 IEC/UL Data	IEC UL	锁线螺钉 Locking crew	-	MC-TI5.0HXXP-BK-0001	2-24
额定电流 Rated current [A]	17.5 12	扭矩 Torque [N·m]	-	MC-TI5.0HXXP-BK-1600	2-24
额定电压 Rated voltage [V]	320 300	固定螺钉 Fixed screw	-	MC-TI5.0VXXP-BK-0001	2-24
硬导线截面积 Solid [mm²][AWG]	0.2-1.5 28-14	扭矩 Torque [N·m]	-	MC-TI5.0VXXP-BK-1600	2-24
柔性导线截面积 Flexible [mm²][AWG]	0.2-1.5 28-14	剥线长度 Strip length [mm]	8-9		
额定冲击电压 Rated impulse voltage [KV]	4 -				

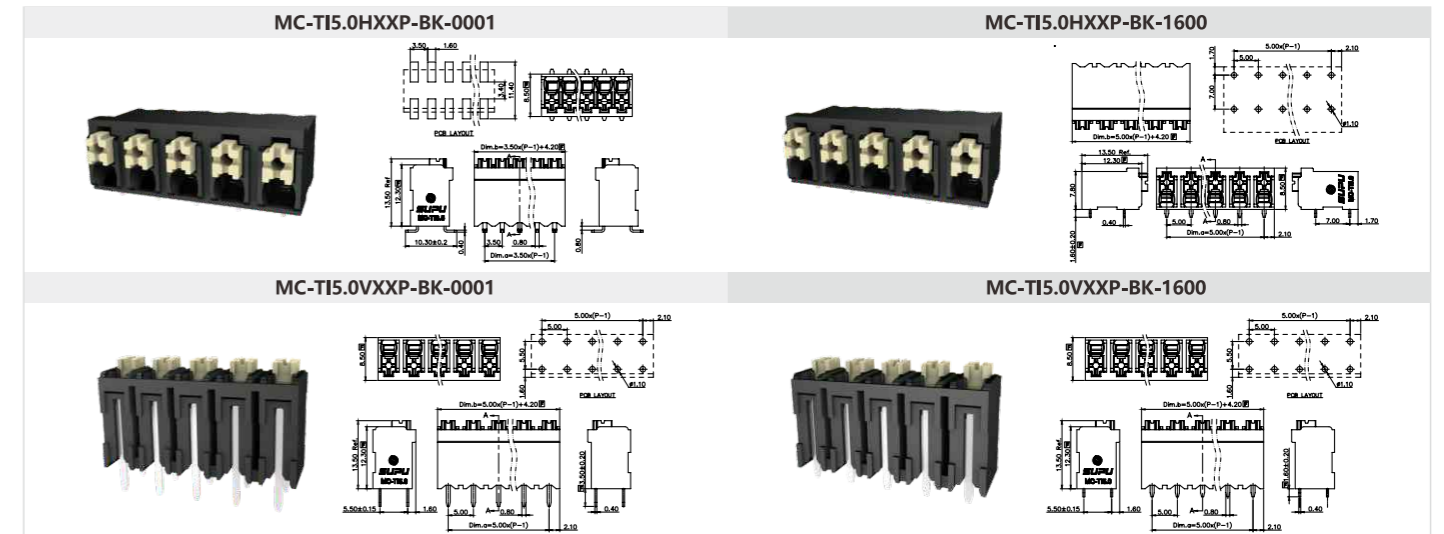

5.0mm间距 Pitch: 5.0mm

产品信息 Product Information		产品信息 Product Information		订货号/通道数 Order No./Poles No.	附件 Accessory
IEC/UL数据 IEC/UL Data	IEC UL	锁线螺钉 Locking crew	-	MC-TI5.0HXXP-BK-0001-SMT	2-24
额定电流 Rated current [A]	17.5 12	扭矩 Torque [N·m]	-	MC-TI5.0VXXP-BK-0001-SMT	2-24
额定电压 Rated voltage [V]	320 300	固定螺钉 Fixed screw	-		
硬导线截面积 Solid [mm²][AWG]	0.2-1.5 24-16	扭矩 Torque [N·m]	-		
柔性导线截面积 Flexible [mm²][AWG]	0.2-1.5 24-16	剥线长度 Strip length [mm]	8-9		
额定冲击电压 Rated impulse voltage [KV]	4 -				

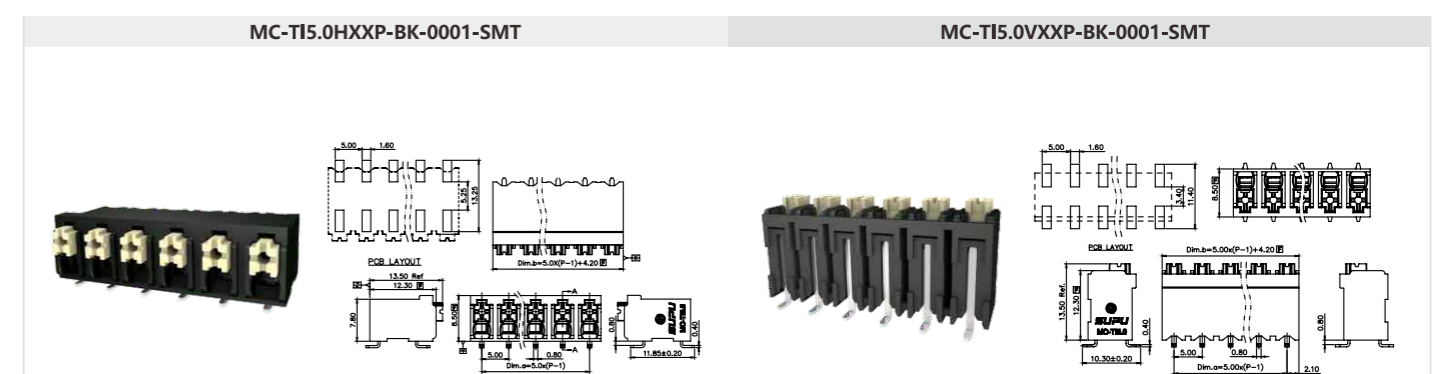

5.0mm间距 Pitch: 5.0mm

产品信息 Product Information		产品信息 Product Information	
IEC/UL数据 IEC/UL Data	IEC UL	锁线螺钉 Locking crew	M3
额定电流 Rated current [A]	14 13.5	扭矩 Torque [N·m]	0.5
额定电压 Rated voltage [V]	320 300	固定螺钉 Fixed screw	-
硬导线截面积 Solid [mm²][AWG]	0.2-1.5 24-16	扭矩 Torque [N·m]	-
柔性导线截面积 Flexible [mm²][AWG]	0.2-1.5 24-16	剥线长度 Strip length [mm]	6-7
额定冲击电压 Rated impulse voltage [KV]	4 -		
订货号/通道数 Order No./Poles No.		附件 Accessory	
MC-TE5.0HXXC-0001	2-24		

MC-TE5.0HXXC-0001

5.0mm间距 Pitch: 5.0mm

产品信息 Product Information		产品信息 Product Information	
IEC/UL数据 IEC/UL Data	IEC UL	锁线螺钉 Locking crew	M3
额定电流 Rated current [A]	13.5 13.5	扭矩 Torque [N·m]	0.5
额定电压 Rated voltage [V]	320 300	固定螺钉 Fixed screw	-
硬导线截面积 Solid [mm²][AWG]	0.2-1.5 30-16	扭矩 Torque [N·m]	-
柔性导线截面积 Flexible [mm²][AWG]	0.2-1.5 30-16	剥线长度 Strip length [mm]	6-7
额定冲击电压 Rated impulse voltage [KV]	4 -		
订货号/通道数 Order No./Poles No.		附件 Accessory	
MC-TEH5.0HXXC-0001	2-24		

MC-TEH5.0HXXC-0001

5.0mm间距 Pitch: 5.0mm

产品信息 Product Information		产品信息 Product Information	
IEC/UL数据 IEC/UL Data	IEC UL	锁线螺钉 Locking crew	M3
额定电流 Rated current [A]	14 13.5	扭矩 Torque [N·m]	0.5
额定电压 Rated voltage [V]	320 300	固定螺钉 Fixed screw	-
硬导线截面积 Solid [mm²][AWG]	0.2-1.5 24-16	扭矩 Torque [N·m]	-
柔性导线截面积 Flexible [mm²][AWG]	0.2-1.5 24-16	剥线长度 Strip length [mm]	6-7
额定冲击电压 Rated impulse voltage [KV]	4 -		
订货号/通道数 Order No./Poles No.		附件 Accessory	
MC-DTE5.0HXXC-0001	2-24		

MC-DTE5.0HXXC-0001

5.0mm间距 Pitch: 5.0mm

产品信息 Product Information		产品信息 Product Information	
IEC/UL数据 IEC/UL Data	IEC UL	锁线螺钉 Locking crew	M3
额定电流 Rated current [A]	24 15	扭矩 Torque [N·m]	0.5
额定电压 Rated voltage [V]	400 300	固定螺钉 Fixed screw	-
硬导线截面积 Solid [mm²][AWG]	0.2-2.5 24-12	扭矩 Torque [N·m]	-
柔性导线截面积 Flexible [mm²][AWG]	0.2-2.5 24-12	剥线长度 Strip length [mm]	7-8
额定冲击电压 Rated impulse voltage [KV]	4 -		
订货号/通道数 Order No./Poles No.		附件 Accessory	
MC-TD5.0HXXC-0001	2-24		

MC-TD5.0HXXC-0001

5.0mm间距 Pitch: 5.0mm

产品信息 Product Information		产品信息 Product Information	
IEC/UL数据 IEC/UL Data	IEC UL	锁线螺钉 Locking crew	M3
额定电流 Rated current [A]	24 15	扭矩 Torque [N·m]	0.5
额定电压 Rated voltage [V]	400 300	固定螺钉 Fixed screw	-
硬导线截面积 Solid [mm²][AWG]	0.2-2.5 24-12	扭矩 Torque [N·m]	-
柔性导线截面积 Flexible [mm²][AWG]	0.2-2.5 24-12	剥线长度 Strip length [mm]	7-8
额定冲击电压 Rated impulse voltage [KV]	4 -		
订货号/通道数 Order No./Poles No.		附件 Accessory	
MC-TD5.0AXXC-0001	2-24		

MC-TD5.0AXXC-0001

5.0mm间距 Pitch: 5.0mm

产品信息 Product Information		产品信息 Product Information	
IEC/UL数据 IEC/UL Data	IEC UL	锁线螺钉 Locking crew	M3
额定电流 Rated current [A]	24 15	扭矩 Torque [N·m]	0.5
额定电压 Rated voltage [V]	400 300	固定螺钉 Fixed screw	-
硬导线截面积 Solid [mm²][AWG]	0.2-2.5 24-12	扭矩 Torque [N·m]	-
柔性导线截面积 Flexible [mm²][AWG]	0.2-2.5 24-12	剥线长度 Strip length [mm]	7-8
额定冲击电压 Rated impulse voltage [KV]	4 -		
订货号/通道数 Order No./Poles No.		附件 Accessory	
MC-DTD5.0HXXC-0001	4-48		

MC-DTD5.0HXXC-0001

5.0mm间距 Pitch: 5.0mm

产品信息 Product Information		产品信息 Product Information	
IEC/UL数据 IEC/UL Data	IEC UL	锁线螺钉 Locking crew	M3
额定电流 Rated current [A]	24 15	扭矩 Torque [N·m]	0.5
额定电压 Rated voltage [V]	400 300	固定螺钉 Fixed screw	-
硬导线截面积 Solid [mm²][AWG]	0.2-2.5 24-12	扭矩 Torque [N·m]	-
柔性导线截面积 Flexible [mm²][AWG]	0.2-2.5 24-12	剥线长度 Strip length [mm]	7-8
额定冲击电压 Rated impulse voltage [KV]	4 -		
订货号/通道数 Order No./Poles No.		附件 Accessory	
MC-TF5.0HXXC-0001	2-24		

MC-TF5.0HXXC-0001

5.0mm间距 Pitch: 5.0mm

产品信息 Product Information		产品信息 Product Information	
IEC/UL数据 IEC/UL Data	IEC UL	锁线螺钉 Locking crew	M3
额定电流 Rated current [A]	24 15	扭矩 Torque [N·m]	0.5
额定电压 Rated voltage [V]	400 300	固定螺钉 Fixed screw	-
硬导线截面积 Solid [mm²][AWG]	0.2-2.5 24-12	扭矩 Torque [N·m]	-
柔性导线截面积 Flexible [mm²][AWG]	0.2-2.5 24-12	剥线长度 Strip length [mm]	7-8
额定冲击电压 Rated impulse voltage [KV]	4 -		
订货号/通道数 Order No./Poles No.		附件 Accessory	
MC-TF5.0AXXC-0001	2-24		

MC-TF5.0AXXC-0001

5.0mm间距 Pitch: 5.0mm

产品信息 Product Information		产品信息 Product Information	
IEC/UL数据 IEC/UL Data	IEC UL	锁线螺钉 Locking crew	M3
额定电流 Rated current [A]	24 15	扭矩 Torque [N·m]	0.5
额定电压 Rated voltage [V]	400 300	固定螺钉 Fixed screw	-
硬导线截面积 Solid [mm²][AWG]	0.2-2.5 24-12	扭矩 Torque [N·m]	-
柔性导线截面积 Flexible [mm²][AWG]	0.2-2.5 24-12	剥线长度 Strip length [mm]	7-8
额定冲击电压 Rated impulse voltage [KV]	4 -		
订货号/通道数 Order No./Poles No.		附件 Accessory	
MC-DTF5.0HXXC-0001	4-48		

MC-DTF5.0HXXC-0001

5.0mm间距 Pitch: 5.0mm

产品信息 Product Information		产品信息 Product Information	
IEC/UL数据 IEC/UL Data	IEC UL	锁线螺钉 Locking crew	-
额定电流 Rated current [A]	24 20	扭矩 Torque [N·m]	-
额定电压 Rated voltage [V]	320 300	固定螺钉 Fixed screw	-
硬导线截面积 Solid [mm²][AWG]	0.2-2.5 24-12	扭矩 Torque [N·m]	-
柔性导线截面积 Flexible [mm²][AWG]	0.2-1.5 24-12	剥线长度 Strip length [mm]	8-9
额定冲击电压 Rated impulse voltage [KV]	4 -		
订货号/通道数 Order No./Poles No.		附件 Accessory	
MC-TC5.0VXXP-N-GY-0001	1P-12P		

MC-TC5.0VXXP-N-GY-0001

5.0mm间距 Pitch: 5.0mm

产品信息Product Information		产品信息Product Information		订货号/通道数 Order No./Poles No.		附件Accessory	
IEC/UL数据 IEC/UL Data		锁线螺钉 Locking crew	-	MC-TC5.0VXXP-0001	1-12		
额定电流 Rated current [A]	24	扭矩 Torque [N·m]	-	MC-TC5.0HXXP-0001	1-12		
额定电压 Rated voltage [V]	320	固定螺钉 Fixed screw	-				
硬导线截面积 Solid [mm ²][AWG]	0.2-2.5	扭矩 Torque [N·m]	-				
柔性导线截面积 Flexible [mm ²][AWG]	0.2-1.5	剥线长度 Strip length [mm]	8-9				
额定冲击电压 Rated impulse voltage [KV]	4						

MC-TC5.0VXXP-0001

MC-TC5.0HXXP-0001

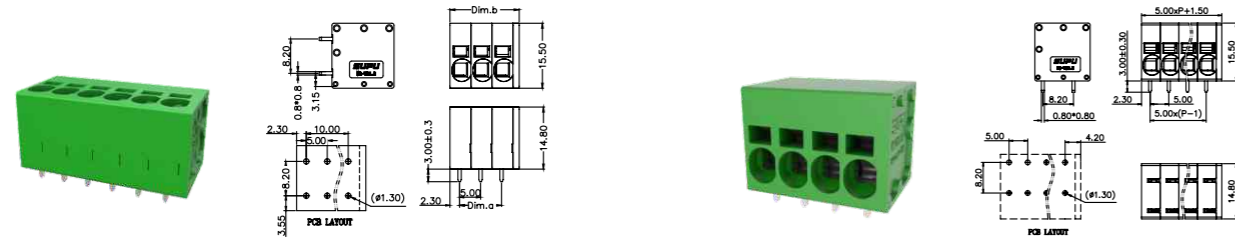

5.08mm间距 Pitch: 5.08mm

产品信息Product Information		产品信息Product Information		订货号/通道数 Order No./Poles No.		附件Accessory	
IEC/UL数据 IEC/UL Data		锁线螺钉 Locking crew	-	MC-TC5.08AXXP-0001	2-24		
额定电流 Rated current [A]	20	扭矩 Torque [N·m]	-				
额定电压 Rated voltage [V]	320	固定螺钉 Fixed screw	-				
硬导线截面积 Solid [mm ²][AWG]	0.2-2.5	扭矩 Torque [N·m]	-				
柔性导线截面积 Flexible [mm ²][AWG]	0.2-2.5	剥线长度 Strip length [mm]	10-11				
额定冲击电压 Rated impulse voltage [KV]	4						

MC-TC5.08AXXP-0001

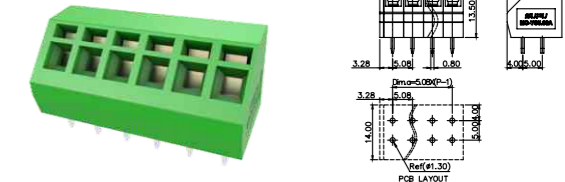

5.08mm间距 Pitch: 5.08mm

产品信息Product Information		产品信息Product Information		订货号/通道数 Order No./Poles No.		附件Accessory	
IEC/UL数据 IEC/UL Data		锁线螺钉 Locking crew	-	MC-DTC5.08AXXP-0001	4-48		
额定电流 Rated current [A]	20	扭矩 Torque [N·m]	-				
额定电压 Rated voltage [V]	320	固定螺钉 Fixed screw	-				
硬导线截面积 Solid [mm ²][AWG]	0.2-2.5	扭矩 Torque [N·m]	-				
柔性导线截面积 Flexible [mm ²][AWG]	0.2-2.5	剥线长度 Strip length [mm]	10-11				
额定冲击电压 Rated impulse voltage [KV]	4						

MC-DTC5.08AXXP-0001

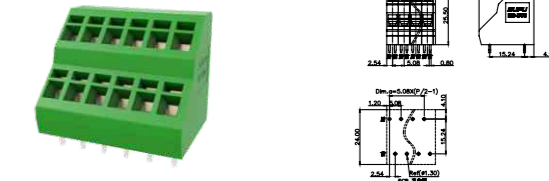

5.0mm间距 Pitch: 5.0mm

产品信息Product Information		产品信息Product Information		订货号/通道数 Order No./Poles No.		附件Accessory	
IEC/UL数据 IEC/UL Data		锁线螺钉 Locking crew	-	MC-TP/B5.0AXXP-BK-0001	2-24		
额定电流 Rated current [A]	17.5	扭矩 Torque [N·m]	-	MC-TP/F5.0AXXP-BK-0001	2-24		
额定电压 Rated voltage [V]	320	固定螺钉 Fixed screw	-	MC-DTP5.0AXXP-BK-0001	4-48		
硬导线截面积 Solid [mm ²][AWG]	0.2-1.5	扭矩 Torque [N·m]	-	MC-TTP5.0AXXP-BK-0001	6-72		
柔性导线截面积 Flexible [mm ²][AWG]	0.2-1.5	剥线长度 Strip length [mm]	9-10	MC-FTP5.0AXXP-BK-0001	8-96		
额定冲击电压 Rated impulse voltage [KV]	4						

MC-TP/B5.0AXXP-BK-0001

MC-TP/F5.0AXXP-BK-0001

MC-DTP5.0AXXP-BK-0001

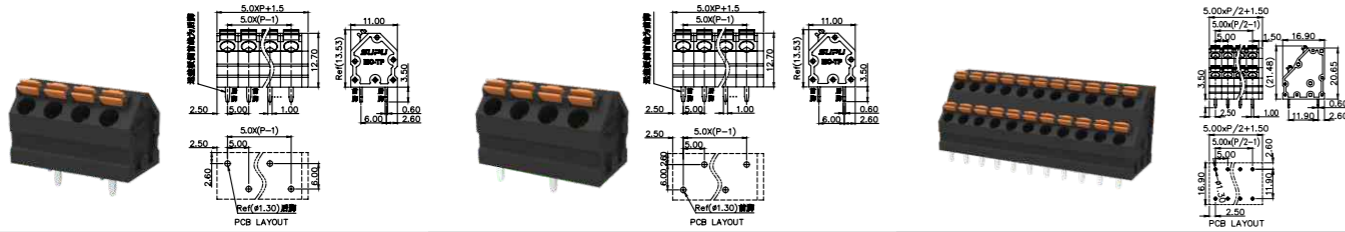

MC-TTP5.0AXXP-BK-0001

MC-FTP5.0AXXP-BK-0001

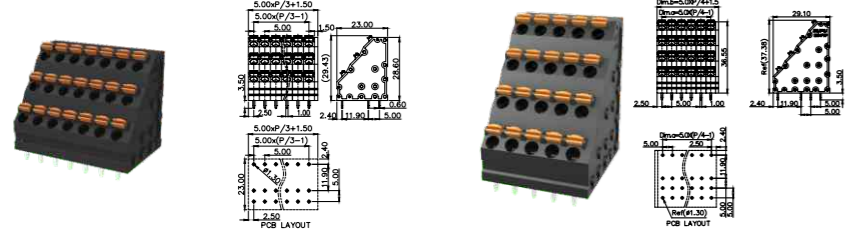

5.08mm间距 Pitch: 5.08mm

产品信息Product Information		产品信息Product Information		订货号/通道数 Order No./Poles No.		附件Accessory	
IEC/UL数据 IEC/UL Data		锁线螺钉 Locking crew	M3	MC-TE5.08HXXC-0001	2-24		
额定电流 Rated current [A]	14	扭矩 Torque [N·m]	0.5				
额定电压 Rated voltage [V]	320	固定螺钉 Fixed screw	-				
硬导线截面积 Solid [mm ²][AWG]	0.2-1.5	扭矩 Torque [N·m]	-				
柔性导线截面积 Flexible [mm ²][AWG]	0.2-1.5	剥线长度 Strip length [mm]	6-7				
额定冲击电压 Rated impulse voltage [KV]	4						

MC-TE5.08HXXC-0001

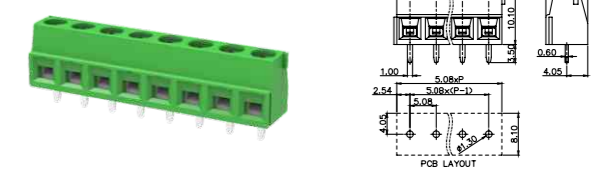

5.08mm间距 Pitch: 5.08mm

产品信息Product Information		产品信息Product Information		订货号/通道数 Order No./Poles No.		附件Accessory	
IEC/UL数据 IEC/UL Data		锁线螺钉 Locking crew	M3	MC-TEH5.08HXXC-0001	2-24		
额定电流 Rated current [A]	13.5	扭矩 Torque [N·m]	0.5				
额定电压 Rated voltage [V]	320	固定螺钉 Fixed screw	-				
硬导线截面积 Solid [mm ²][AWG]	0.2-1.5	扭矩 Torque [N·m]	-				
柔性导线截面积 Flexible [mm ²][AWG]	0.2-1.5	剥线长度 Strip length [mm]	6-7				
额定冲击电压 Rated impulse voltage [KV]	4						

MC-TEH5.08HXXC-0001

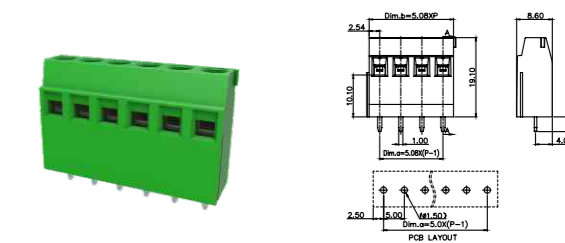

5.0mm间距 Pitch: 5.0mm

产品信息Product Information		产品信息Product Information		订货号/通道数 Order No./Poles No.		附件Accessory	
IEC/UL数据 IEC/UL Data		锁线螺钉 Locking crew	-	MC-TS5.0HXXP-0001	2-24		
额定电流 Rated current [A]	24	扭矩 Torque [N·m]	-				
额定电压 Rated voltage [V]	320	固定螺钉 Fixed screw	-				
硬导线截面积 Solid [mm ²][AWG]	0.2-2.5	扭矩 Torque [N·m]	-				
柔性导线截面积 Flexible [mm ²][AWG]	0.2-2.5	剥线长度 Strip length [mm]	12				
额定冲击电压 Rated impulse voltage [KV]	4						

MC-TS5.0HXXP-0001

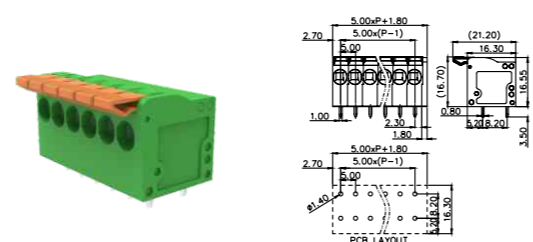

5.08mm间距 Pitch: 5.08mm

产品信息Product Information		产品信息Product Information		订货号/通道数 Order No./Poles No.		附件Accessory	
IEC/UL数据 IEC/UL Data		锁线螺钉 Locking crew	M3	MC-TE5.08AXXC-0001	2-24		
额定电流 Rated current [A]	17.5	扭矩 Torque [N·m]	0.5				
额定电压 Rated voltage [V]	320	固定螺钉 Fixed screw	-				
硬导线截面积 Solid [mm ²][AWG]	0.2-1.5	扭矩 Torque [N·m]	-				
柔性导线截面积 Flexible [mm ²][AWG]	0.2-1.5	剥线长度 Strip length [mm]	6-7				
额定冲击电压 Rated impulse voltage [KV]	4						

MC-TE5.08AXXC-0001

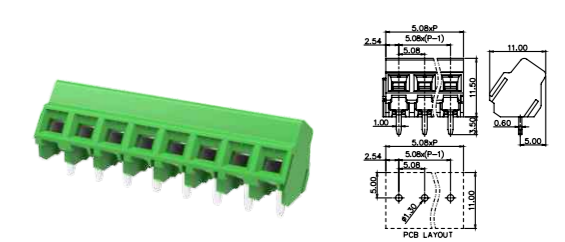

5.08mm间距 Pitch: 5.08mm

产品信息Product Information		产品信息Product Information	
IEC/UL数据 IEC/UL Data	IEC UL	锁线螺钉 Locking crew	M3
额定电流 Rated current [A]	13.5 10	扭矩 Torque [N·m]	0.5
额定电压 Rated voltage [V]	400 300	固定螺钉 Fixed screw	-
硬导线截面积 Solid [mm²][AWG]	0.2-1.5 24-12	扭矩 Torque [N·m]	-
柔性导线截面积 Flexible [mm²][AWG]	0.2-1.5 24-12	剥线长度 Strip length [mm]	5-6
额定冲击电压 Rated impulse voltage [KV]	4 -		
订货号/通道数 Order No./Poles No.		附件Accessory	
MC-TE5.08BXXC-0001		2P-24P	

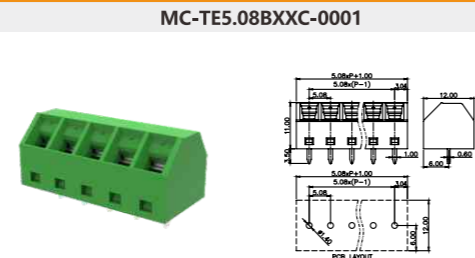

5.08mm间距 Pitch: 5.08mm

产品信息Product Information		产品信息Product Information	
IEC/UL数据 IEC/UL Data	IEC UL	锁线螺钉 Locking crew	M3
额定电流 Rated current [A]	24 15	扭矩 Torque [N·m]	0.5-0.6
额定电压 Rated voltage [V]	400 300	固定螺钉 Fixed screw	-
硬导线截面积 Solid [mm²][AWG]	0.2-2.5 24-12	扭矩 Torque [N·m]	-
柔性导线截面积 Flexible [mm²][AWG]	0.2-2.5 24-12	剥线长度 Strip length [mm]	7-8
额定冲击电压 Rated impulse voltage [KV]	4 -		
订货号/通道数 Order No./Poles No.		附件Accessory	
MC-TT5.08HXXC-0001		6-72	

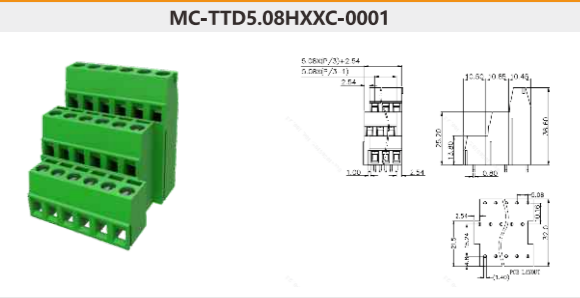

5.08mm间距 Pitch: 5.08mm

产品信息Product Information		产品信息Product Information	
IEC/UL数据 IEC/UL Data	IEC UL	锁线螺钉 Locking crew	M3
额定电流 Rated current [A]	14 13.5	扭矩 Torque [N·m]	0.5
额定电压 Rated voltage [V]	320 300	固定螺钉 Fixed screw	-
硬导线截面积 Solid [mm²][AWG]	0.2-1.5 24-16	扭矩 Torque [N·m]	-
柔性导线截面积 Flexible [mm²][AWG]	0.2-1.5 24-16	剥线长度 Strip length [mm]	6-7
额定冲击电压 Rated impulse voltage [KV]	4 -		
订货号/通道数 Order No./Poles No.		附件Accessory	
MC-DTE5.08HXXC-0001		2-24	

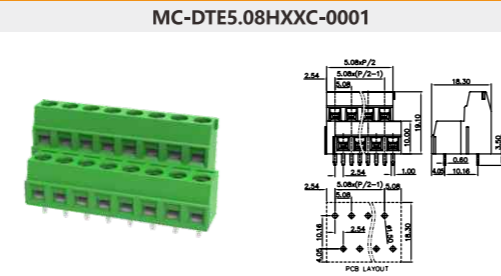

5.08mm间距 Pitch: 5.08mm

产品信息Product Information		产品信息Product Information	
IEC/UL数据 IEC/UL Data	IEC UL	锁线螺钉 Locking crew	M3
额定电流 Rated current [A]	24 15	扭矩 Torque [N·m]	0.5
额定电压 Rated voltage [V]	400 300	固定螺钉 Fixed screw	-
硬导线截面积 Solid [mm²][AWG]	0.2-2.5 24-12	扭矩 Torque [N·m]	-
柔性导线截面积 Flexible [mm²][AWG]	0.2-2.5 24-12	剥线长度 Strip length [mm]	7-8
额定冲击电压 Rated impulse voltage [KV]	4 -		
订货号/通道数 Order No./Poles No.		附件Accessory	
MC-TF5.08HXXC-0001		2-24	

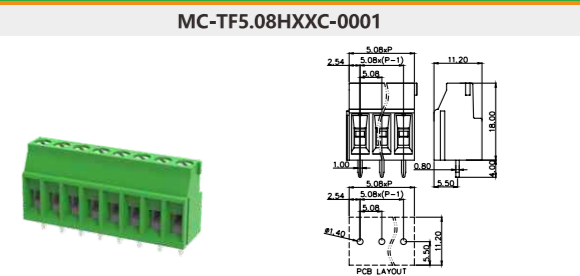

5.08mm间距 Pitch: 5.08mm

产品信息Product Information		产品信息Product Information	
IEC/UL数据 IEC/UL Data	IEC UL	锁线螺钉 Locking crew	M3
额定电流 Rated current [A]	24 15	扭矩 Torque [N·m]	0.5
额定电压 Rated voltage [V]	400 300	固定螺钉 Fixed screw	-
硬导线截面积 Solid [mm²][AWG]	0.2-2.5 24-16	扭矩 Torque [N·m]	-
柔性导线截面积 Flexible [mm²][AWG]	0.2-1.5 24-16	剥线长度 Strip length [mm]	7-8
额定冲击电压 Rated impulse voltage [KV]	4 -		
订货号/通道数 Order No./Poles No.		附件Accessory	
MC-TD5.08HXXC-0001		2-24	

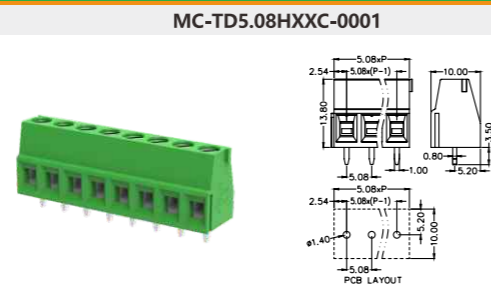

5.08mm间距 Pitch: 5.08mm

产品信息Product Information		产品信息Product Information	
IEC/UL数据 IEC/UL Data	IEC UL	锁线螺钉 Locking crew	M3
额定电流 Rated current [A]	24 20	扭矩 Torque [N·m]	0.5
额定电压 Rated voltage [V]	400 300	固定螺钉 Fixed screw	-
硬导线截面积 Solid [mm²][AWG]	0.2-2.5 24-12	扭矩 Torque [N·m]	-
柔性导线截面积 Flexible [mm²][AWG]	0.2-2.5 24-12	剥线长度 Strip length [mm]	7-8
额定冲击电压 Rated impulse voltage [KV]	4 -		
订货号/通道数 Order No./Poles No.		附件Accessory	
MC-TF5.08AXXC-0001		2-24	

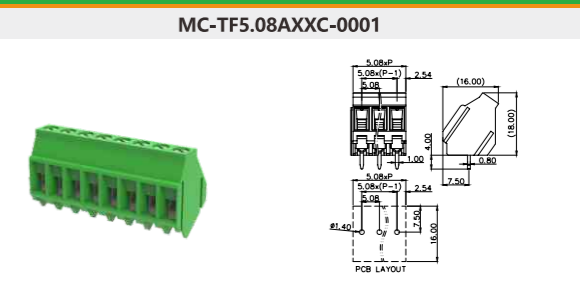

5.08mm间距 Pitch: 5.08mm

产品信息Product Information		产品信息Product Information	
IEC/UL数据 IEC/UL Data	IEC UL	锁线螺钉 Locking crew	M3
额定电流 Rated current [A]	24 15	扭矩 Torque [N·m]	0.5
额定电压 Rated voltage [V]	400 250	固定螺钉 Fixed screw	-
硬导线截面积 Solid [mm²][AWG]	0.2-2.5 24-12	扭矩 Torque [N·m]	-
柔性导线截面积 Flexible [mm²][AWG]	0.2-2.5 24-12	剥线长度 Strip length [mm]	7-8
额定冲击电压 Rated impulse voltage [KV]	4 -		
订货号/通道数 Order No./Poles No.		附件Accessory	
MC-TD5.08AXXC-0001		2-24	

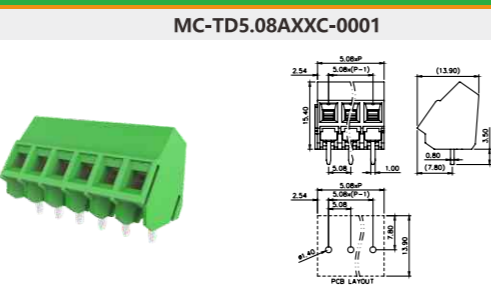

5.08mm间距 Pitch: 5.08mm

产品信息Product Information		产品信息Product Information	
IEC/UL数据 IEC/UL Data	IEC UL	锁线螺钉 Locking crew	M3
额定电流 Rated current [A]	20 10	扭矩 Torque [N·m]	0.5
额定电压 Rated voltage [V]	400 250	固定螺钉 Fixed screw	-
硬导线截面积 Solid [mm²][AWG]	0.2-2.5 24-12	扭矩 Torque [N·m]	-
柔性导线截面积 Flexible [mm²][AWG]	0.2-2.5 24-12	剥线长度 Strip length [mm]	10-11
额定冲击电压 Rated impulse voltage [KV]	4 -		
订货号/通道数 Order No./Poles No.		附件Accessory	
MC-TF5.08CXXC-0001		2-24	

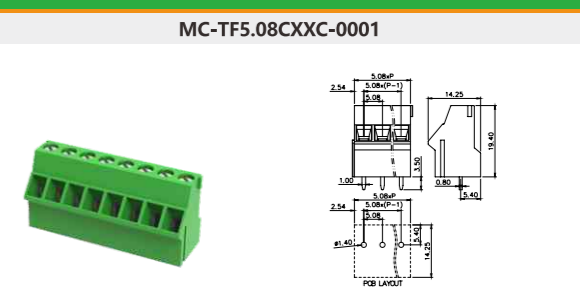

5.08mm间距 Pitch: 5.08mm

产品信息Product Information		产品信息Product Information	
IEC/UL数据 IEC/UL Data	IEC UL	锁线螺钉 Locking crew	M3
额定电流 Rated current [A]	24 15	扭矩 Torque [N·m]	0.5
额定电压 Rated voltage [V]	400 300	固定螺钉 Fixed screw	-
硬导线截面积 Solid [mm²][AWG]	0.2-2.5 24-12	扭矩 Torque [N·m]	-
柔性导线截面积 Flexible [mm²][AWG]	0.2-2.5 24-12	剥线长度 Strip length [mm]	7-8
额定冲击电压 Rated impulse voltage [KV]	4 -		
订货号/通道数 Order No./Poles No.		附件Accessory	
MC-DTD5.08HXXC-0001		2-24	

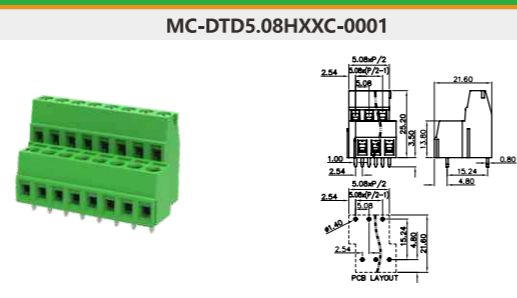

5.08mm间距 Pitch: 5.08mm

产品信息Product Information		产品信息Product Information	
IEC/UL数据 IEC/UL Data	IEC UL	锁线螺钉 Locking crew	M3
额定电流 Rated current [A]	24 15	扭矩 Torque [N·m]	0.5
额定电压 Rated voltage [V]	400 125	固定螺钉 Fixed screw	-
硬导线截面积 Solid [mm²][AWG]	0.2-2.5 24-12	扭矩 Torque [N·m]	-
柔性导线截面积 Flexible [mm²][AWG]	0.2-2.5 24-12	剥线长度 Strip length [mm]	7-8
额定冲击电压 Rated impulse voltage [KV]	4 -		
订货号/通道数 Order No./Poles No.		附件Accessory	
MC-DTF5.08HXXC-0001		2-24	

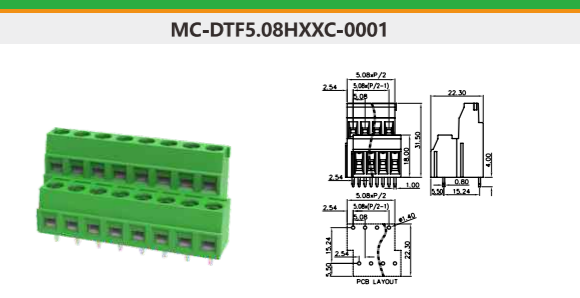

5.08mm间距 Pitch: 5.08mm

产品信息 Product Information		IEC		UL		产品信息 Product Information	
IEC/UL数据 IEC/UL Data		IEC	UL	锁线螺钉 Locking crew	-	扭距 Torque	[N·m]
额定电流 Rated current	[A]	24	10	固定螺钉 Fixed screw	-	扭距 Torque	[N·m]
额定电压 Rated voltage	[V]	400	300	固定螺钉 Fixed screw	-	扭距 Torque	[N·m]
硬导线截面积 Solid	[mm ²][AWG]	0.2-2.5	24-12	扭距 Torque	[N·m]	-	-
柔性导线截面积 Flexible	[mm ²][AWG]	0.2-2.5	24-12	剥线长度 Strip length	[mm]	7-8	-
额定冲击电压 Rated impulse voltage	[KV]	4	-				
订货号/通道数 Order No./Poles No.		附件 Accessory					
MC-TTF5.08HXXC-0001		6P-72P					

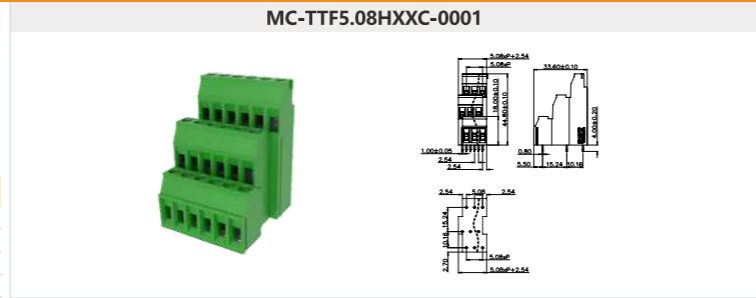

5.08mm间距 Pitch: 5.08mm

产品信息 Product Information		IEC		UL		产品信息 Product Information	
IEC/UL数据 IEC/UL Data		IEC	UL	锁线螺钉 Locking crew	-	扭距 Torque	[N·m]
额定电流 Rated current	[A]	15	10	固定螺钉 Fixed screw	-	扭距 Torque	[N·m]
额定电压 Rated voltage	[V]	400	300	固定螺钉 Fixed screw	-	扭距 Torque	[N·m]
硬导线截面积 Solid	[mm ²][AWG]	0.2-1.5	24-16	扭距 Torque	[N·m]	-	-
柔性导线截面积 Flexible	[mm ²][AWG]	0.2-1.5	24-16	剥线长度 Strip length	[mm]	10	-
额定冲击电压 Rated impulse voltage	[KV]	4	-				
订货号/通道数 Order No./Poles No.		附件 Accessory					
MC-TC5.08VXXP-N-0001		1P-54P					

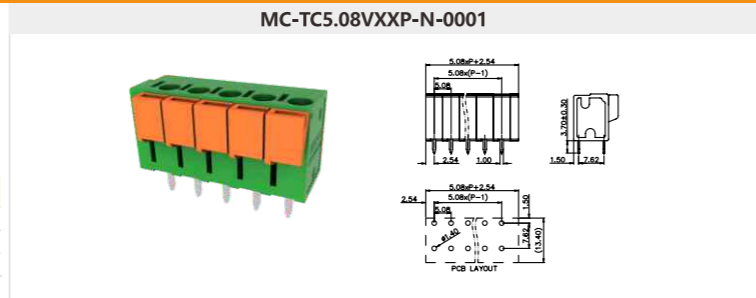

6.35mm间距 Pitch: 6.35mm

产品信息 Product Information		IEC		UL		产品信息 Product Information	
IEC/UL数据 IEC/UL Data		IEC	UL	锁线螺钉 Locking crew	M3	扭距 Torque	[N·m]
额定电流 Rated current	[A]	32	30	固定螺钉 Fixed screw	-	扭距 Torque	[N·m]
额定电压 Rated voltage	[V]	630	300	固定螺钉 Fixed screw	-	扭距 Torque	[N·m]
硬导线截面积 Solid	[mm ²][AWG]	0.2-6.0	24-10	扭距 Torque	[N·m]	-	-
柔性导线截面积 Flexible	[mm ²][AWG]	0.2-6.0	24-10	剥线长度 Strip length	[mm]	8-9	-
额定冲击电压 Rated impulse voltage	[KV]	6	-				
订货号/通道数 Order No./Poles No.		附件 Accessory					
MC-TG6.35HXXC-0001		2P-12P					

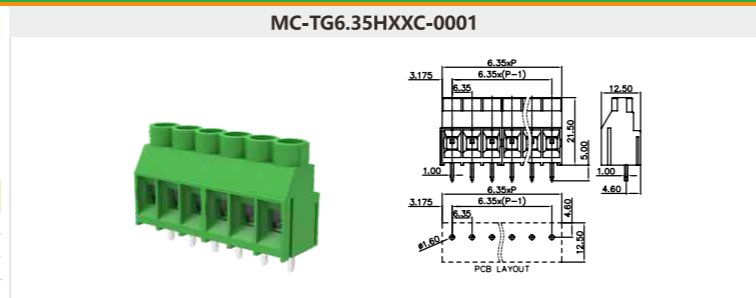

6.35mm间距 Pitch: 6.35mm

产品信息 Product Information		IEC		UL		产品信息 Product Information	
IEC/UL数据 IEC/UL Data		IEC	UL	锁线螺钉 Locking crew	M3	扭距 Torque	[N·m]
额定电流 Rated current	[A]	41	30	固定螺钉 Fixed screw	-	扭距 Torque	[N·m]
额定电压 Rated voltage	[V]	1000	600	固定螺钉 Fixed screw	-	扭距 Torque	[N·m]
硬导线截面积 Solid	[mm ²][AWG]	0.2-6.0	24-10	扭距 Torque	[N·m]	-	-
柔性导线截面积 Flexible	[mm ²][AWG]	0.2-6.0	24-10	剥线长度 Strip length	[mm]	8-9	-
额定冲击电压 Rated impulse voltage	[KV]	8	-				
订货号/通道数 Order No./Poles No.		附件 Accessory					
MC-TH/F6.35HXXC-0001		1P-12P					

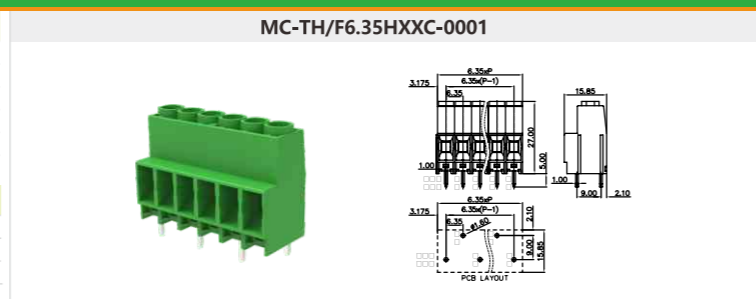

7.5mm间距 Pitch: 7.5mm

产品信息 Product Information		IEC		UL		产品信息 Product Information	
IEC/UL数据 IEC/UL Data		IEC	UL	锁线螺钉 Locking crew	M3	扭距 Torque	[N·m]
额定电流 Rated current	[A]	32	30	固定螺钉 Fixed screw	-	扭距 Torque	[N·m]
额定电压 Rated voltage	[V]	630	300	固定螺钉 Fixed screw	-	扭距 Torque	[N·m]
硬导线截面积 Solid	[mm ²][AWG]	0.2-4.0	24-10	扭距 Torque	[N·m]	-	-
柔性导线截面积 Flexible	[mm ²][AWG]	0.2-4.0	24-10	剥线长度 Strip length	[mm]	8-9	-
额定冲击电压 Rated impulse voltage	[KV]	6	-				
订货号/通道数 Order No./Poles No.		附件 Accessory					
MC-TH7.5HXXC-0001		2P-12P					

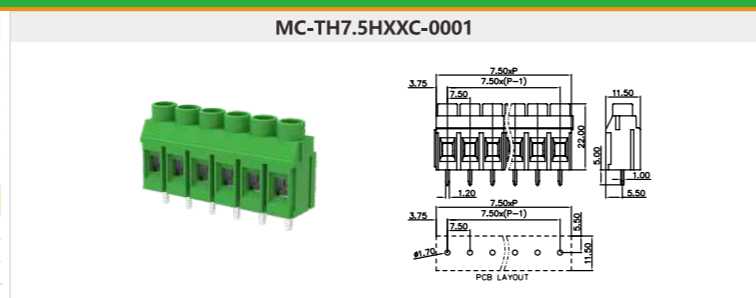

7.5mm间距 Pitch: 7.5mm

产品信息 Product Information		IEC		UL		产品信息 Product Information		订货号/通道数 Order No./Poles No.		附件 Accessory	
IEC/UL数据 IEC/UL Data		IEC	UL	锁线螺钉 Locking crew	-	扭距 Torque	[N·m]	MC-TC7.5HXXP-0001	1P-16		
额定电流 Rated current	[A]	41	36	固定螺钉 Fixed screw	-	扭距 Torque	[N·m]	MC-TC/B7.5HXXP-0001 (W针脚)	1P-16		
额定电压 Rated voltage	[V]	1000	600	固定螺钉 Fixed screw	-	扭距 Torque	[N·m]	TC/B7.5HXXP-0001 (M针脚)	1P-16		
硬导线截面积 Solid	[mm ²][AWG]	0.2-10	24-8	扭距 Torque	[N·m]	-	-	MC-TC7.5VXXP-0001	1P-16		
柔性导线截面积 Flexible	[mm ²][AWG]	0.2-6	24-8	剥线长度 Strip length	[mm]	13-15	-	MC-TC/F7.5VXXP-0001 (W针脚)	1P-16		
额定冲击电压 Rated impulse voltage	[KV]	8	-					MC-TC/F7.5VXXP-0001 (M针脚)	1P-16		

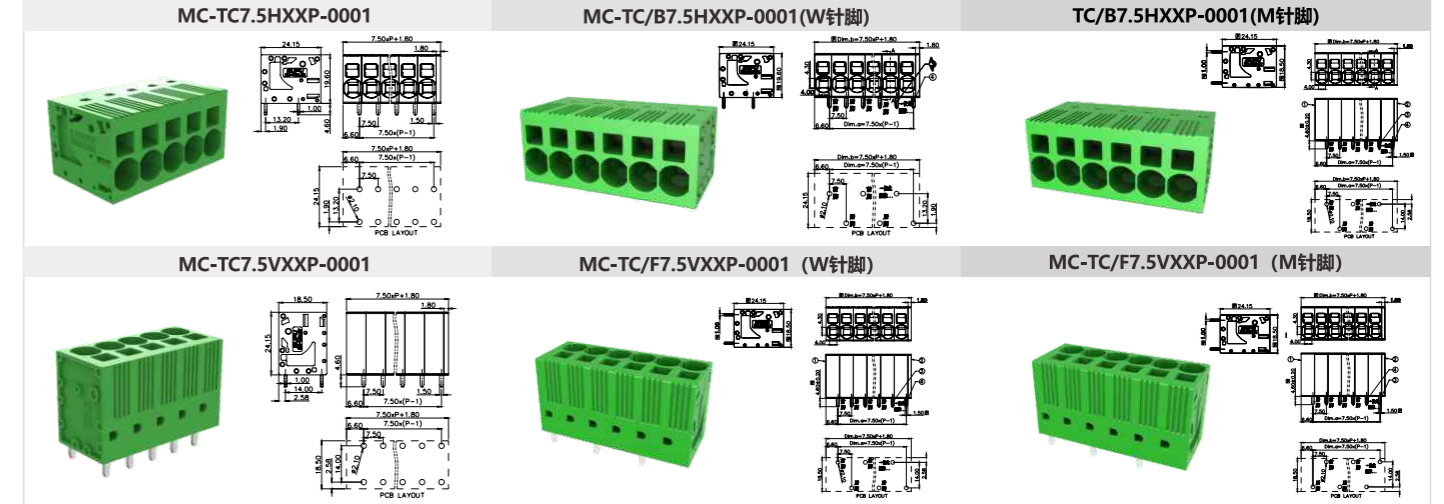

7.62mm间距 Pitch: 7.62mm

产品信息 Product Information		IEC		UL		产品信息 Product Information	
IEC/UL数据 IEC/UL Data		IEC	UL	锁线螺钉 Locking crew	-	扭距 Torque	[N·m]
额定电流 Rated current	[A]	15	10	固定螺钉 Fixed screw	-	扭距 Torque	[N·m]
额定电压 Rated voltage	[V]	630	300	固定螺钉 Fixed screw	-	扭距 Torque	[N·m]
硬导线截面积 Solid	[mm ²][AWG]	0.2-1.5	24-16	扭距 Torque	[N·m]	-	-
柔性导线截面积 Flexible	[mm ²][AWG]	0.2-1.5	24-16	剥线长度 Strip length	[mm]	10	-
额定冲击电压 Rated impulse voltage	[KV]	6	-				
订货号/通道数 Order No./Poles No.		附件 Accessory					
MC-TC7.62VXXP-N-0001		1P-24P					

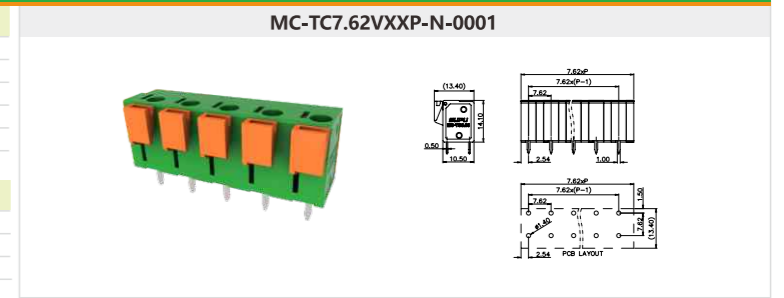

7.62mm间距 Pitch: 7.62mm

产品信息 Product Information		IEC		UL		产品信息 Product Information	
IEC/UL数据 IEC/UL Data		IEC	UL	锁线螺钉 Locking crew	M3	扭距 Torque	[N·m]
额定电流 Rated current	[A]	24	15	固定螺钉 Fixed screw	-	扭距 Torque	[N·m]
额定电压 Rated voltage	[V]	630	250	固定螺钉 Fixed screw	-	扭距 Torque	[N·m]
硬导线截面积 Solid	[mm ²][AWG]	0.2-2.5	24-12	扭距 Torque	[N·m]	-	-
柔性导线截面积 Flexible	[mm ²][AWG]	0.2-2.5	24-12	剥线长度 Strip length	[mm]	7-8	-
额定冲击电压 Rated impulse voltage	[KV]	6	-				
订货号/通道数 Order No./Poles No.		附件 Accessory					
MC-TD7.62HXXC-0001		2P-16P					

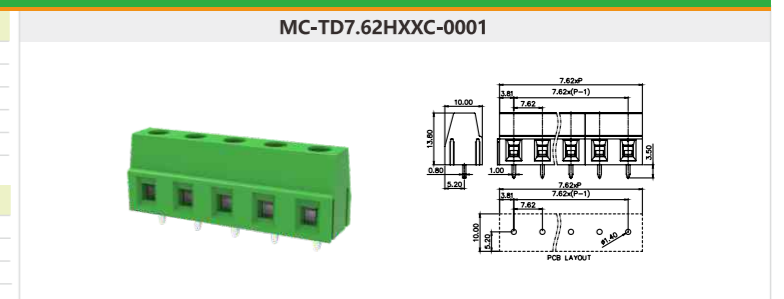

7.62mm间距 Pitch: 7.62mm

产品信息 Product Information		IEC		UL		产品信息 Product Information	
IEC/UL数据 IEC/UL Data		IEC	UL	锁线螺钉 Locking crew	M3	扭距 Torque	[N·m]
额定电流 Rated current	[A]	24	15	固定螺钉 Fixed screw	-	扭距 Torque	[N·m]
额定电压 Rated voltage	[V]	630	300	固定螺钉 Fixed screw	-	扭距 Torque	[N·m]
硬导线截面积 Solid	[mm ²][AWG]	0.2-2.5	24-12	扭距 Torque	[N·m]	-	-
柔性导线截面积 Flexible	[mm ²][AWG]	0.2-2.5	24-12	剥线长度 Strip length	[mm]	7-8	-
额定冲击电压 Rated impulse voltage	[KV]	6	-				
订货号/通道数 Order No./Poles No.		附件 Accessory					
MC-TF7.62HXXC-0001		2P-24P					

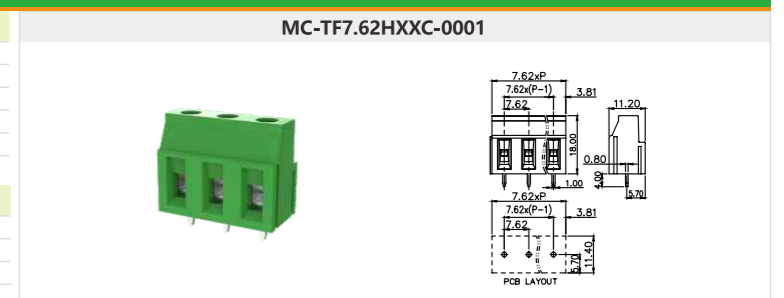

7.62mm间距 Pitch: 7.62mm

产品信息 Product Information		产品信息 Product Information	
IEC/UL数据 IEC/UL Data	IEC UL	锁线螺钉 Locking crew	M3
额定电流 Rated current [A]	32 30	扭矩 Torque [N·m]	0.5
额定电压 Rated voltage [V]	630 300	固定螺钉 Fixed screw	-
硬导线截面积 Solid [mm²][AWG]	0.2-6.0 24-10	扭矩 Torque [N·m]	-
柔性导线截面积 Flexible [mm²][AWG]	0.2-6.0 24-10	剥线长度 Strip length [mm]	8-9
额定冲击电压 Rated impulse voltage [KV]	6 -		
订货号/通道数 Order No./Poles No.		附件 Accessory	
MC-TG7.62HXXC-0001 2P-12P			

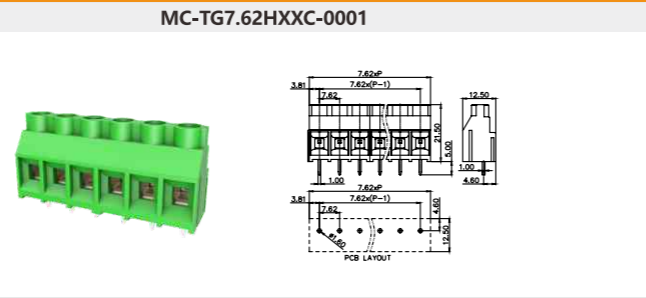

9.52mm间距 Pitch: 9.52mm

产品信息 Product Information		产品信息 Product Information	
IEC/UL数据 IEC/UL Data	IEC UL	锁线螺钉 Locking crew	M3
额定电流 Rated current [A]	32 30	扭矩 Torque [N·m]	0.5
额定电压 Rated voltage [V]	1000 300	固定螺钉 Fixed screw	-
硬导线截面积 Solid [mm²][AWG]	0.2-6.0 24-10	扭矩 Torque [N·m]	-
柔性导线截面积 Flexible [mm²][AWG]	0.2-6.0 24-10	剥线长度 Strip length [mm]	8-9
额定冲击电压 Rated impulse voltage [KV]	6 -		
订货号/通道数 Order No./Poles No.		附件 Accessory	
MC-TG9.52HXXC-0001 2P-12P			

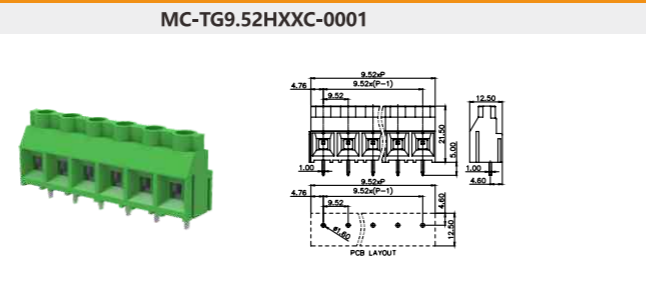

9.52mm间距 Pitch: 9.52mm

产品信息 Product Information		产品信息 Product Information	
IEC/UL数据 IEC/UL Data	IEC UL	锁线螺钉 Locking crew	M3
额定电流 Rated current [A]	32 30	扭矩 Torque [N·m]	0.5
额定电压 Rated voltage [V]	1000 300	固定螺钉 Fixed screw	-
硬导线截面积 Solid [mm²][AWG]	0.2-6.0 24-10	扭矩 Torque [N·m]	-
柔性导线截面积 Flexible [mm²][AWG]	0.2-6.0 24-10	剥线长度 Strip length [mm]	8-9
额定冲击电压 Rated impulse voltage [KV]	8 -		
订货号/通道数 Order No./Poles No.		附件 Accessory	
MC-TH9.52HXXC-0001 2P-12P			

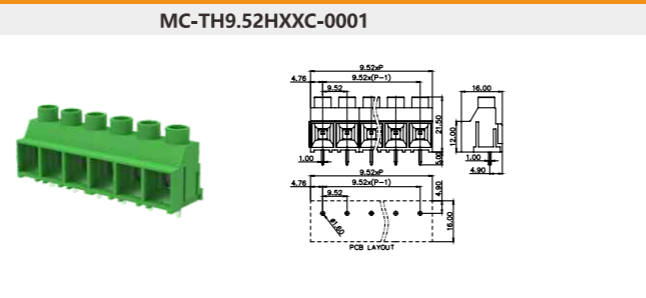

9.52mm间距 Pitch: 9.52mm

产品信息 Product Information		产品信息 Product Information	
IEC/UL数据 IEC/UL Data	IEC UL	锁线螺钉 Locking crew	M3
额定电流 Rated current [A]	32 30	扭矩 Torque [N·m]	0.5
额定电压 Rated voltage [V]	1000 600	固定螺钉 Fixed screw	-
硬导线截面积 Solid [mm²][AWG]	0.2-6.0 24-10	扭矩 Torque [N·m]	-
柔性导线截面积 Flexible [mm²][AWG]	0.2-6.0 24-10	剥线长度 Strip length [mm]	8-9
额定冲击电压 Rated impulse voltage [KV]	8 -		
订货号/通道数 Order No./Poles No.		附件 Accessory	
MC-TH/F9.52HXXC-0001 2P-12P			

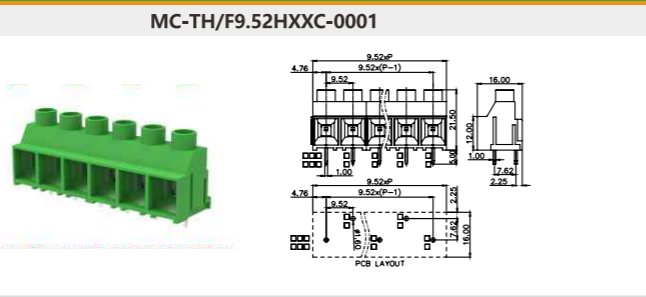

10.16mm间距 Pitch: 10.16mm

产品信息 Product Information		产品信息 Product Information	
IEC/UL数据 IEC/UL Data	IEC UL	锁线螺钉 Locking crew	M4
额定电流 Rated current [A]	57 65	扭矩 Torque [N·m]	1.2
额定电压 Rated voltage [V]	1000 300	固定螺钉 Fixed screw	-
硬导线截面积 Solid [mm²][AWG]	0.5-16 20-6	扭矩 Torque [N·m]	-
柔性导线截面积 Flexible [mm²][AWG]	0.5-16 20-6	剥线长度 Strip length [mm]	11-12
额定冲击电压 Rated impulse voltage [KV]	8 -		
订货号/通道数 Order No./Poles No.		附件 Accessory	
MC-TJ10.16HXXC-0001 2P-12P			

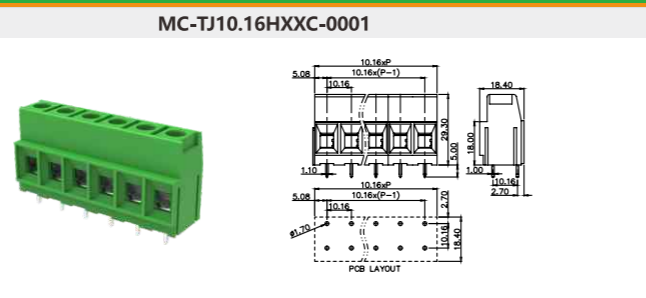

10.16mm间距 Pitch: 10.16mm

产品信息 Product Information		产品信息 Product Information		订货号/通道数 Order No./Poles No.	附件 Accessory
IEC/UL数据 IEC/UL Data	IEC UL	锁线螺钉 Locking crew	M4	MC-TH10.16HXXC-0001	2-12
额定电流 Rated current [A]	76 60	扭矩 Torque [N·m]	1.2	MC-TH/B10.16H01C-0001	1
额定电压 Rated voltage [V]	1000 600	固定螺钉 Fixed screw	-	MC-TH/F10.16H01C-0001	1
硬导线截面积 Solid [mm²][AWG]	0.5-16 20-6	扭矩 Torque [N·m]	-		
柔性导线截面积 Flexible [mm²][AWG]	0.5-16 20-6	剥线长度 Strip length [mm]	10-12		
额定冲击电压 Rated impulse voltage [KV]	8 -				

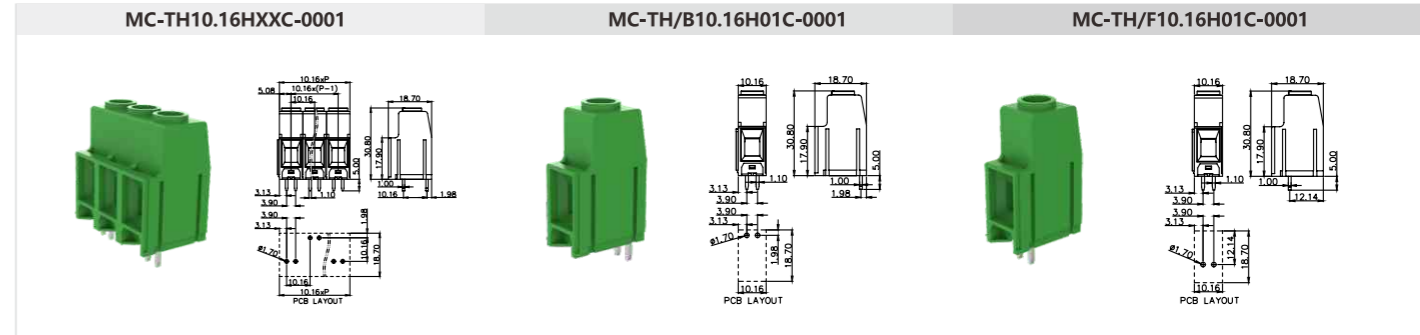

15.0mm间距 Pitch: 15.0mm

产品信息 Product Information		产品信息 Product Information		订货号/通道数 Order No./Poles No.	附件 Accessory
IEC/UL数据 IEC/UL Data	IEC UL	锁线螺钉 Locking crew	M5	MC-TK15HXXC-0001	2-9
额定电流 Rated current [A]	125 115	扭矩 Torque [N·m]	2.0	MC-TK15HXXC-B-0001	2-9
额定电压 Rated voltage [V]	1000 600	固定螺钉 Fixed screw	-	MC-TK15H01C-BL-0001	1
硬导线截面积 Solid [mm²][AWG]	0.5-35 20-2	扭矩 Torque [N·m]	-	MC-TK15H01C-BR-0001	1
柔性导线截面积 Flexible [mm²][AWG]	0.5-35 -	剥线长度 Strip length [mm]	18-19		
额定冲击电压 Rated impulse voltage [KV]	8 -				

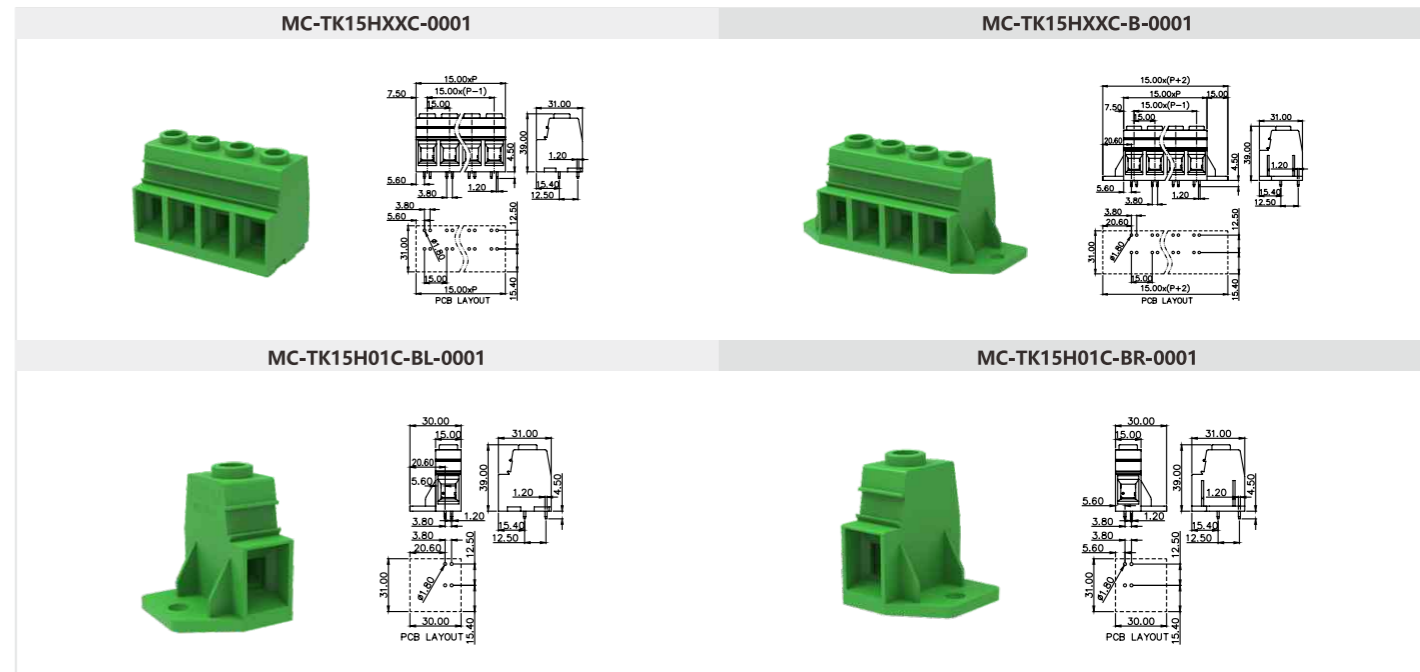

235系列单孔PCB端子排 235 Series single hole PCB terminal block 间距 Pitch: 5.0mm

产品信息Product Information			
IEC/UL数据 IEC/UL Data	IEC	UL	
额定电流 Rated current	[A] 17.5	10	
额定电压 Rated voltage	[V] 320	300	
硬导线截面积 Solid [mm ²][AWG]	0.2-2.5	24-16	
柔性导线截面积 Flexible [mm ²][AWG]	0.2-2.5	24-16	
额定冲击电压 Rated impulse voltage	[KV] 4.0	-	
锁线螺钉 Locking crew		-	
扭矩 Torque	[N-m] -	-	
固定螺钉 Fixed screw		-	
扭矩 Torque	[N-m] -	-	
剥线长度 Strip length	[mm] 9-10	-	

订货号/通道数 Order No./Poles No.			
2352XX/010	2-24	2352XX	2-24

235系列单孔PCB端子排 235 Series single hole PCB terminal block 间距 Pitch: 7.5mm

产品信息Product Information			
IEC/UL数据 IEC/UL Data	IEC	UL	
额定电流 Rated current	[A] 17.5	10	
额定电压 Rated voltage	[V] 630	300	
硬导线截面积 Solid [mm ²][AWG]	0.2-1.5	24-14	
柔性导线截面积 Flexible [mm ²][AWG]	0.2-1.5	24-14	
额定冲击电压 Rated impulse voltage	[KV] 6.0	-	
锁线螺钉 Locking crew		-	
扭矩 Torque	[N-m] -	-	
固定螺钉 Fixed screw		-	
扭矩 Torque	[N-m] -	-	
剥线长度 Strip length	[mm] 9-10	-	

订货号/通道数 Order No./Poles No.			
2353XX/010	2-24	2353XX	2-24

235系列单孔PCB端子排 235 Series single hole PCB terminal block 间距 Pitch: 10.0mm

产品信息Product Information			
IEC/UL数据 IEC/UL Data	IEC	UL	
额定电流 Rated current	[A] 17.5	10	
额定电压 Rated voltage	[V] 1000	300	
硬导线截面积 Solid [mm ²][AWG]	0.2-1.5	24-14	
柔性导线截面积 Flexible [mm ²][AWG]	0.2-1.5	24-14	
额定冲击电压 Rated impulse voltage	[KV] 8.0	-	
锁线螺钉 Locking crew		-	
扭矩 Torque	[N-m] -	-	
固定螺钉 Fixed screw		-	
扭矩 Torque	[N-m] -	-	
剥线长度 Strip length	[mm] 9-10	-	

订货号/通道数 Order No./Poles No.			
2354XX/010	2-24	2354XX	2-24

239系列单孔PCB端子排 239 Series single hole PCB terminal block 间距 Pitch: 3.5mm

产品信息Product Information			
IEC/UL数据 IEC/UL Data	IEC	UL	
额定电流 Rated current	[A] 17.5	6	
额定电压 Rated voltage	[V] 160	300	
硬导线截面积 Solid [mm ²][AWG]	0.2-1.5	28-14	
柔性导线截面积 Flexible [mm ²][AWG]	0.2-1.5	28-14	
额定冲击电压 Rated impulse voltage	[KV] 2.5	-	
锁线螺钉 Locking crew		-	
扭矩 Torque	[N-m] -	-	
固定螺钉 Fixed screw		-	
扭矩 Torque	[N-m] -	-	
剥线长度 Strip length	[mm] 5-6	-	

订货号/通道数 Order No./Poles No.			
2393XX/010	2-24	2393XX	2-24

239系列单孔PCB端子排 239 Series single hole PCB terminal block 间距 Pitch: 5.0mm

产品信息Product Information			
IEC/UL数据 IEC/UL Data	IEC	UL	
额定电流 Rated current	[A] 24	12	
额定电压 Rated voltage	[V] 320	300	
硬导线截面积 Solid [mm ²][AWG]	0.2-2.5	28-12	
柔性导线截面积 Flexible [mm ²][AWG]	0.2-2.5	28-12	
额定冲击电压 Rated impulse voltage	[KV] 4.0	-	
锁线螺钉 Locking crew		-	
扭矩 Torque	[N-m] -	-	
固定螺钉 Fixed screw		-	
扭矩 Torque	[N-m] -	-	
剥线长度 Strip length	[mm] 8-9	-	

订货号/通道数 Order No./Poles No.			
2391XX	2-24		

239系列单孔PCB端子排 239 Series single hole PCB terminal block 间距 Pitch: 7.5mm

产品信息Product Information			
IEC/UL数据 IEC/UL Data	IEC	UL	
额定电流 Rated current	[A] 24	12	
额定电压 Rated voltage	[V] 630	300	
硬导线截面积 Solid [mm ²][AWG]	0.2-2.5	28-12	
柔性导线截面积 Flexible [mm ²][AWG]	0.2-2.5	28-12	
额定冲击电压 Rated impulse voltage	[KV] 6.0	-	
锁线螺钉 Locking crew		-	
扭矩 Torque	[N-m] -	-	
固定螺钉 Fixed screw		-	
扭矩 Torque	[N-m] -	-	
剥线长度 Strip length	[mm] 8-9	-	

订货号/通道数 Order No./Poles No.			
2392XX	2-24		

239系列单孔PCB端子排 239 Series single hole PCB terminal block 间距 Pitch: 5.08mm

产品信息Product Information			
IEC/UL数据 IEC/UL Data	IEC	UL	
额定电流 Rated current	[A] 24	12	
额定电压 Rated voltage	[V] 320	300	
硬导线截面积 Solid [mm ²][AWG]	0.2-2.5	28-12	
柔性导线截面积 Flexible [mm ²][AWG]	0.2-2.5	28-12	
额定冲击电压 Rated impulse voltage	[KV] 4.0	-	
锁线螺钉 Locking crew		-	
扭矩 Torque	[N-m] -	-	
固定螺钉 Fixed screw		-	
扭矩 Torque	[N-m] -	-	
剥线长度 Strip length	[mm] 8-9	-	

订货号/通道数 Order No./Poles No.			
23915X	2-24		

239系列单孔PCB端子排 239 Series single hole PCB terminal block 间距 Pitch: 7.62mm

产品信息Product Information			
IEC/UL数据 IEC/UL Data	IEC	UL	
额定电流 Rated current	[A] 24	12	
额定电压 Rated voltage	[V] 630	300	
硬导线截面积 Solid [mm ²][AWG]	0.2-2.5	28-12	
柔性导线截面积 Flexible [mm ²][AWG]	0.2-2.5	28-12	
额定冲击电压 Rated impulse voltage	[KV] 6.0	-	
锁线螺钉 Locking crew		-	
扭矩 Torque	[N-m] -	-	
固定螺钉 Fixed screw		-	
扭矩 Torque	[N-m] -	-	
剥线长度 Strip length	[mm] 8-9	-	

订货号/通道数 Order No./Poles No.			
23925X	2-24		

245系列PCB端子排 245 Series PCB terminal block 间距 Pitch: 5.0mm

产品信息Product Information			
IEC/UL数据 IEC/UL Data	IEC	UL	
额定电流 Rated current	[A] 32	20	
额定电压 Rated voltage	[V] 320	300	
硬导线截面积 Solid [mm ²][AWG]	0.2-4.0	28-12	
柔性导线截面积 Flexible [mm ²][AWG]	0.2-4.0	28-12	
额定冲击电压 Rated impulse voltage	[KV] 4.0	-	
锁线螺钉 Locking crew		-	
扭矩 Torque	[N-m] -	-	
固定螺钉 Fixed screw		-	
扭矩 Torque	[N-m] -	-	
剥线长度 Strip length	[mm] 8-9	-	

订货号/通道数 Order /Poles No.			
2452XX/020	2-24	2452XX	2-24

245系列PCB端子排 245 Series PCB terminal block 间距 Pitch: 7.5mm

产品信息Product Information			
IEC/UL数据 IEC/UL Data	IEC	UL	
额定电流 Rated current	[A] 32	20	
额定电压 Rated voltage	[V] 630	300	
硬导线截面积 Solid [mm ²][AWG]	0.2-4.0	28-12	
柔性导线截面积 Flexible [mm ²][AWG]	0.2-4.0	28-12	
额定冲击电压 Rated impulse voltage	[KV] 6.0	-	
锁线螺钉 Locking crew		-	
扭矩 Torque	[N-m] -	-	
固定螺钉 Fixed screw		-	
扭矩 Torque	[N-m] -	-	
剥线长度 Strip length	[mm] 8-9	-	

订货号/通道数 Order No./Poles No.			
2453XX/020	2-24	2453XX	2-24

245系列PCB端子排 245 Series PCB terminal block 间距 Pitch: 10.0mm

产品信息 Product Information			
IEC/UL数据 IEC/UL Data	IEC	UL	
额定电流 Rated current	[A]	32	20
额定电压 Rated voltage	[V]	1000	300
硬导线截面积 Solid [mm ²][AWG]		0.2-4.0	28-12
柔性导线截面积 Flexible [mm ²][AWG]		0.2-4.0	28-12
额定冲击电压 Rated impulse voltage	[KV]	8.0	-
锁线螺钉 Locking crew		-	-
扭矩 Torque	[N-m]	-	-
固定螺钉 Fixed screw		-	-
扭矩 Torque	[N-m]	-	-
剥线长度 Strip length	[mm]	8-9	-



255系列PCB端子排 255 Series PCB terminal block 间距 Pitch: 5.0mm

产品信息 Product Information			
IEC/UL数据 IEC/UL Data	IEC	UL	
额定电流 Rated current	[A]	24	20
额定电压 Rated voltage	[V]	320	300
硬导线截面积 Solid [mm ²][AWG]		0.2-2.5	28-12
柔性导线截面积 Flexible [mm ²][AWG]		0.2-2.5	28-12
额定冲击电压 Rated impulse voltage	[KV]	4.0	-
锁线螺钉 Locking crew		-	-
扭矩 Torque	[N-m]	-	-
固定螺钉 Fixed screw		-	-
扭矩 Torque	[N-m]	-	-
剥线长度 Strip length	[mm]	5-6	-

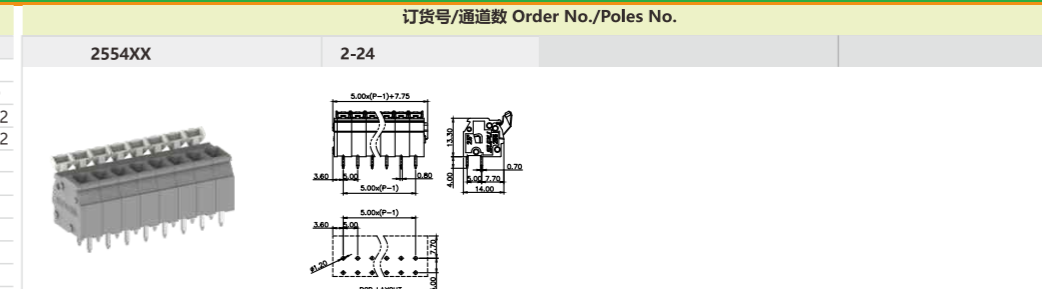

246系列PCB端子排 246 Series PCB terminal block 间距 Pitch: 7.5mm

产品信息 Product Information			
IEC/UL数据 IEC/UL Data	IEC	UL	
额定电流 Rated current	[A]	41	30
额定电压 Rated voltage	[V]	630	300
硬导线截面积 Solid [mm ²][AWG]		0.2-6.0	24-10
柔性导线截面积 Flexible [mm ²][AWG]		0.2-6.0	24-10
额定冲击电压 Rated impulse voltage	[KV]	6.0	-
锁线螺钉 Locking crew		-	-
扭矩 Torque	[N-m]	-	-
固定螺钉 Fixed screw		-	-
扭矩 Torque	[N-m]	-	-
剥线长度 Strip length	[mm]	11-12	-

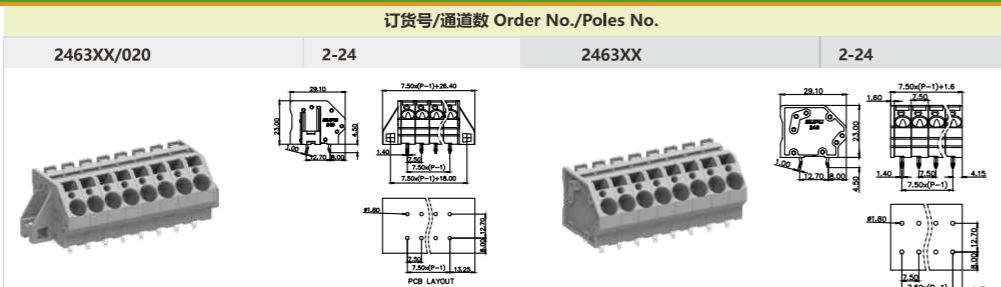

255系列PCB端子排 255 Series PCB terminal block 间距 Pitch: 7.5mm

产品信息 Product Information			
IEC/UL数据 IEC/UL Data	IEC	UL	
额定电流 Rated current	[A]	24	20
额定电压 Rated voltage	[V]	630	300
硬导线截面积 Solid [mm ²][AWG]		0.2-2.5	28-12
柔性导线截面积 Flexible [mm ²][AWG]		0.2-2.5	28-12
额定冲击电压 Rated impulse voltage	[KV]	6.0	-
锁线螺钉 Locking crew		-	-
扭矩 Torque	[N-m]	-	-
固定螺钉 Fixed screw		-	-
扭矩 Torque	[N-m]	-	-
剥线长度 Strip length	[mm]	5-6	-

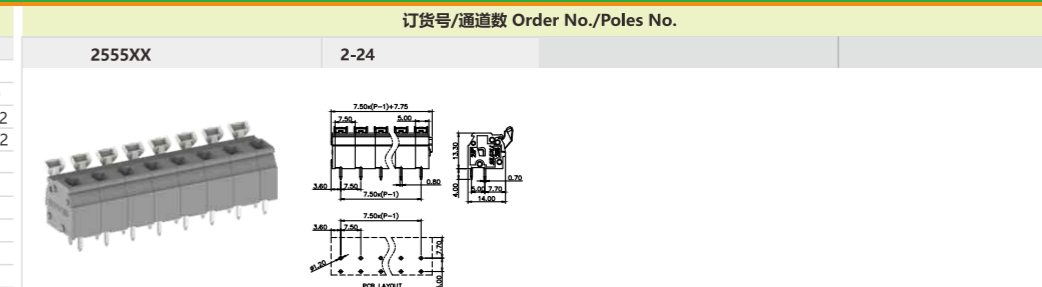

246系列PCB端子排 246 Series PCB terminal block 间距 Pitch: 10.0mm

产品信息 Product Information			
IEC/UL数据 IEC/UL Data	IEC	UL	
额定电流 Rated current	[A]	41	30
额定电压 Rated voltage	[V]	1000	300
硬导线截面积 Solid [mm ²][AWG]		0.2-6.0	24-10
柔性导线截面积 Flexible [mm ²][AWG]		0.2-6.0	24-10
额定冲击电压 Rated impulse voltage	[KV]	8.0	-
锁线螺钉 Locking crew		-	-
扭矩 Torque	[N-m]	-	-
固定螺钉 Fixed screw		-	-
扭矩 Torque	[N-m]	-	-
剥线长度 Strip length	[mm]	11-12	-

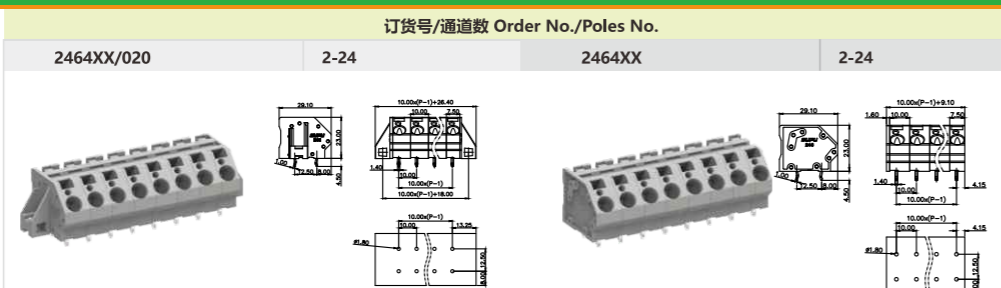

256系列PCB端子排 256 Series PCB terminal block 间距 Pitch: 5.0mm

产品信息 Product Information			
IEC/UL数据 IEC/UL Data	IEC	UL	
额定电流 Rated current	[A]	24	20
额定电压 Rated voltage	[V]	320	300
硬导线截面积 Solid [mm ²][AWG]		0.2-2.5	28-12
柔性导线截面积 Flexible [mm ²][AWG]		0.2-2.5	28-12
额定冲击电压 Rated impulse voltage	[KV]	4.0	-
锁线螺钉 Locking crew		-	-
扭矩 Torque	[N-m]	-	-
固定螺钉 Fixed screw		-	-
扭矩 Torque	[N-m]	-	-
剥线长度 Strip length	[mm]	5-6	-

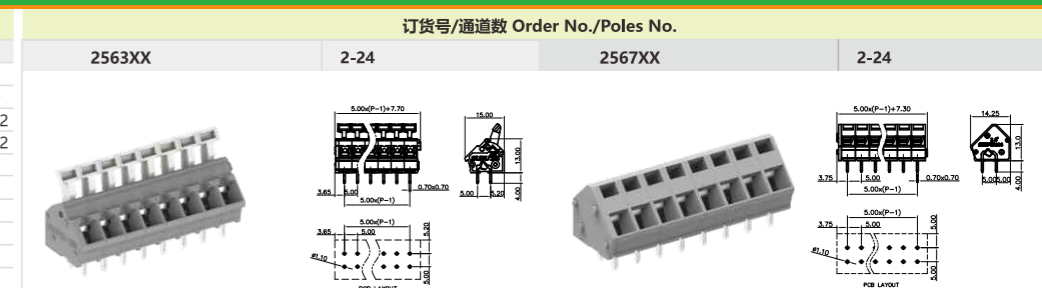

250系列PCB端子排 250 Series PCB terminal block 间距 Pitch: 3.5mm

产品信息 Product Information			
IEC/UL数据 IEC/UL Data	IEC	UL	
额定电流 Rated current	[A]	8	5
额定电压 Rated voltage	[V]	160	300
硬导线截面积 Solid [mm ²][AWG]		0.2-1.5	24-16
柔性导线截面积 Flexible [mm ²][AWG]		0.2-1.5	24-16
额定冲击电压 Rated impulse voltage	[KV]	2.5	-
锁线螺钉 Locking crew		-	-
扭矩 Torque	[N-m]	-	-
固定螺钉 Fixed screw		-	-
扭矩 Torque	[N-m]	-	-
剥线长度 Strip length	[mm]	8.5-9.5	-

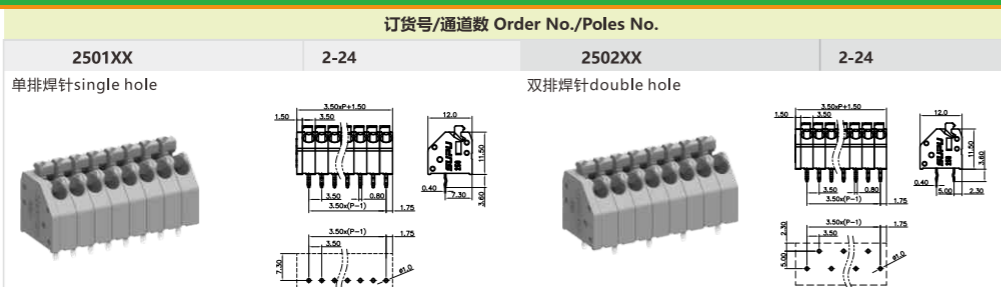

256系列PCB端子排 256 Series PCB terminal block 间距 Pitch: 7.5mm

产品信息 Product Information			
IEC/UL数据 IEC/UL Data	IEC	UL	
额定电流 Rated current	[A]	24	20
额定电压 Rated voltage	[V]	320	300
硬导线截面积 Solid [mm ²][AWG]		0.2-2.5	28-12
柔性导线截面积 Flexible [mm ²][AWG]		0.2-2.5	28-12
额定冲击电压 Rated impulse voltage	[KV]	4.0	-
锁线螺钉 Locking crew		-	-
扭矩 Torque	[N-m]	-	-
固定螺钉 Fixed screw		-	-
扭矩 Torque	[N-m]	-	-
剥线长度 Strip length	[mm]	5-6	-

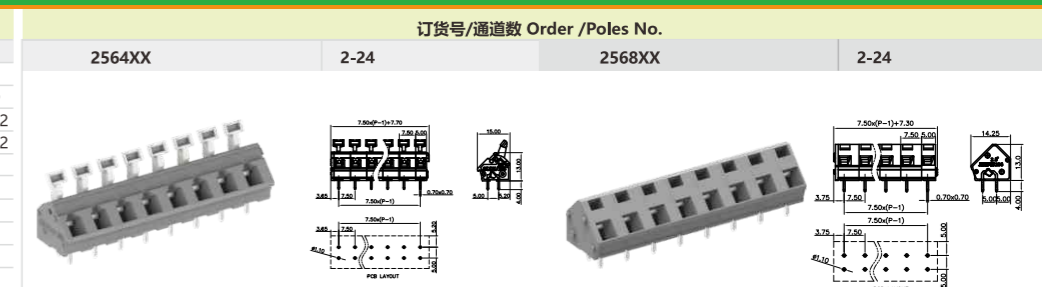

250系列PCB端子排 250 Series PCB terminal block 间距 Pitch: 5.0mm

产品信息 Product Information			
IEC/UL数据 IEC/UL Data	IEC	UL	
额定电流 Rated current	[A]	17.5	10
额定电压 Rated voltage	[V]	320	300
硬导线截面积 Solid [mm ²][AWG]		0.5-1.5	20-16
柔性导线截面积 Flexible [mm ²][AWG]		0.5-1.5	20-16
额定冲击电压 Rated impulse voltage	[KV]	4.0	-
锁线螺钉 Locking crew		-	-
扭矩 Torque	[N-m]	-	-
固定螺钉 Fixed screw		-	-
扭矩 Torque	[N-m]	-	-
剥线长度 Strip length	[mm]	9-10	-

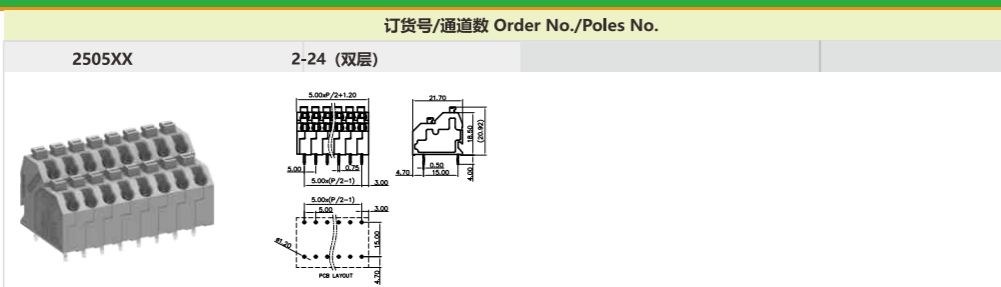

256系列PCB端子排 256 Series PCB terminal block 间距 Pitch: 10.0mm

产品信息 Product Information			
IEC/UL数据 IEC/UL Data	IEC	UL	
额定电流 Rated current	[A]	24	20
额定电压 Rated voltage	[V]	1000	300
硬导线截面积 Solid [mm ²][AWG]		0.2-2.5	28-12
柔性导线截面积 Flexible [mm ²][AWG]		0.2-2.5	28-12
额定冲击电压 Rated impulse voltage	[KV]	8.0	-
锁线螺钉 Locking crew		-	-
扭矩 Torque	[N-m]	-	-
固定螺钉 Fixed screw		-	-
扭矩 Torque	[N-m]	-	-
剥线长度 Strip length	[mm]	5-6	-

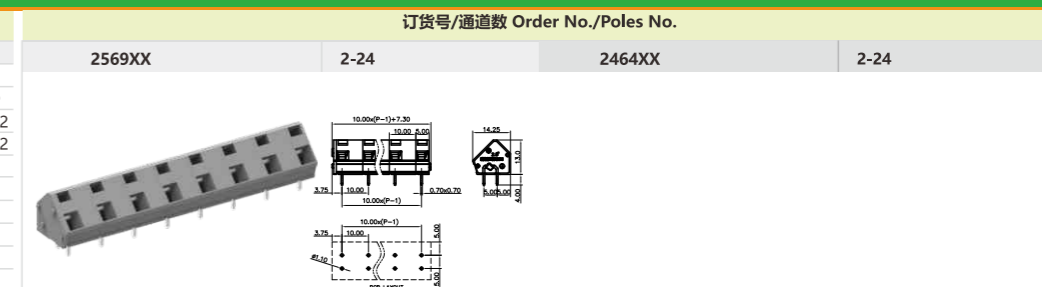

257系列PCB端子排 257 Series PCB terminal block 间距 Pitch: 5.0mm

产品信息 Product Information			
IEC/UL数据 IEC/UL Data	IEC	UL	
额定电流 Rated current	[A]	21	10
额定电压 Rated voltage	[V]	320	300
硬导线截面积 Solid [mm ²][AWG]	0.2-2.5	24-14	
柔性导线截面积 Flexible [mm ²][AWG]	0.2-2.5	24-14	
额定冲击电压 Rated impulse voltage	[KV]	4.0	-
锁线螺钉 Locking crew		-	
扭矩 Torque	[N-m]	-	
固定螺钉 Fixed screw		-	
扭矩 Torque	[N-m]	-	
剥线长度 Strip length	[mm]	5-6	

订货号/通道数 Order No./Poles No.	
2572XX	2-24 (双层)

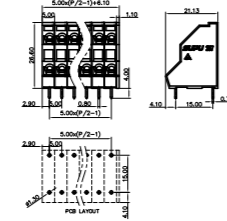
257系列PCB端子排 257 Series PCB terminal block 间距 Pitch: 7.5mm

产品信息 Product Information			
IEC/UL数据 IEC/UL Data	IEC	UL	
额定电流 Rated current	[A]	21	10
额定电压 Rated voltage	[V]	630	300
硬导线截面积 Solid [mm ²][AWG]	0.2-2.5	24-14	
柔性导线截面积 Flexible [mm ²][AWG]	0.2-2.5	24-14	
额定冲击电压 Rated impulse voltage	[KV]	6.0	-
锁线螺钉 Locking crew		-	
扭矩 Torque	[N-m]	-	
固定螺钉 Fixed screw		-	
扭矩 Torque	[N-m]	-	
剥线长度 Strip length	[mm]	5-6	

订货号/通道数 Order No./Poles No.	
2573XX	2-24 (双层)

246系列PCB端子排 246 Series PCB terminal block 间距 Pitch: 10.0mm

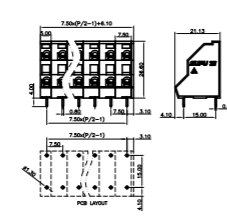
产品信息 Product Information			
IEC/UL数据 IEC/UL Data	IEC	UL	
额定电流 Rated current	[A]	21	10
额定电压 Rated voltage	[V]	1000	300
硬导线截面积 Solid [mm ²][AWG]	0.2-2.5	24-14	
柔性导线截面积 Flexible [mm ²][AWG]	0.2-2.5	24-14	
额定冲击电压 Rated impulse voltage	[KV]	8.0	-
锁线螺钉 Locking crew		-	
扭矩 Torque	[N-m]	-	
固定螺钉 Fixed screw		-	
扭矩 Torque	[N-m]	-	
剥线长度 Strip length	[mm]	5-6	

订货号/通道数 Order No./Poles No.	
2574XX	2-24 (双层)

258系列PCB端子排 258 Series PCB terminal block 间距 Pitch: 5.0mm

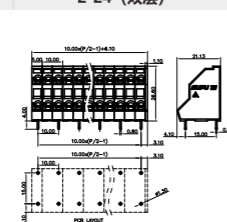
产品信息 Product Information			
IEC/UL数据 IEC/UL Data	IEC	UL	
额定电流 Rated current	[A]	21	10
额定电压 Rated voltage	[V]	320	300
硬导线截面积 Solid [mm ²][AWG]	0.2-2.5	26-12	
柔性导线截面积 Flexible [mm ²][AWG]	0.2-2.5	26-12	
额定冲击电压 Rated impulse voltage	[KV]	4.0	-
锁线螺钉 Locking crew		-	
扭矩 Torque	[N-m]	-	
固定螺钉 Fixed screw		-	
扭矩 Torque	[N-m]	-	
剥线长度 Strip length	[mm]	5-6	

订货号/通道数 Order No./Poles No.	
2582XX	2-24 (三层)

258系列PCB端子排 258 Series PCB terminal block 间距 Pitch: 7.5mm

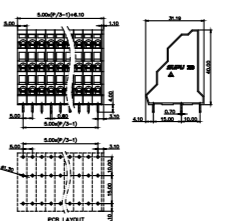
产品信息 Product Information			
IEC/UL数据 IEC/UL Data	IEC	UL	
额定电流 Rated current	[A]	16	10
额定电压 Rated voltage	[V]	630	300
硬导线截面积 Solid [mm ²][AWG]	0.2-2.5	26-12	
柔性导线截面积 Flexible [mm ²][AWG]	0.2-2.5	26-12	
额定冲击电压 Rated impulse voltage	[KV]	6.0	-
锁线螺钉 Locking crew		-	
扭矩 Torque	[N-m]	-	
固定螺钉 Fixed screw		-	
扭矩 Torque	[N-m]	-	
剥线长度 Strip length	[mm]	5-6	

订货号/通道数 Order No./Poles No.	
2583XX	2-24 (三层)

MCS连接器选型配比表
MCS connector selection ratio table

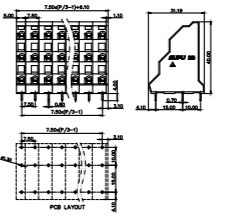
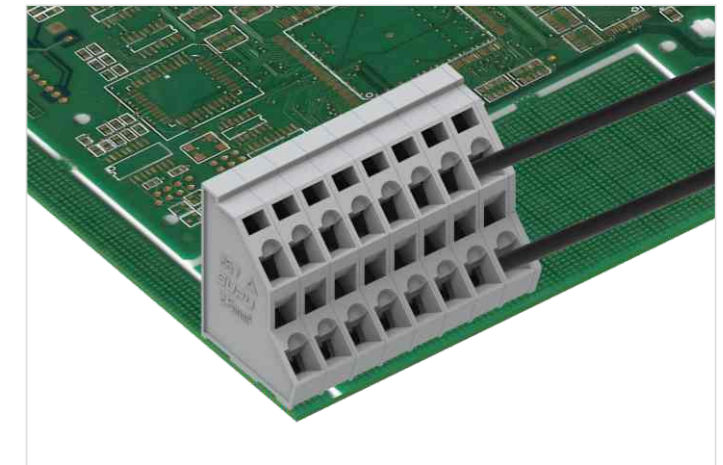
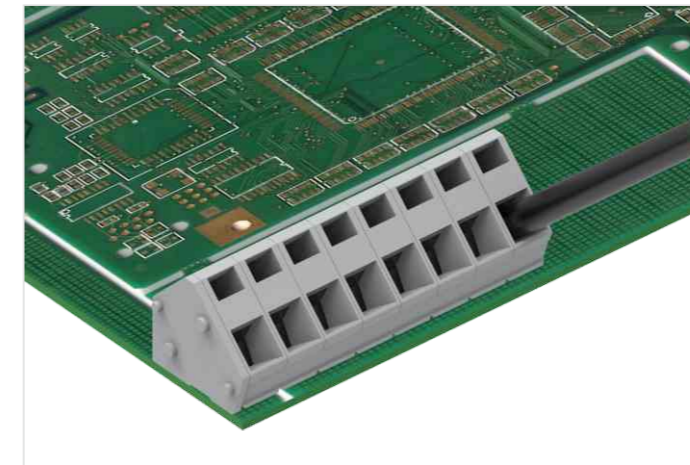
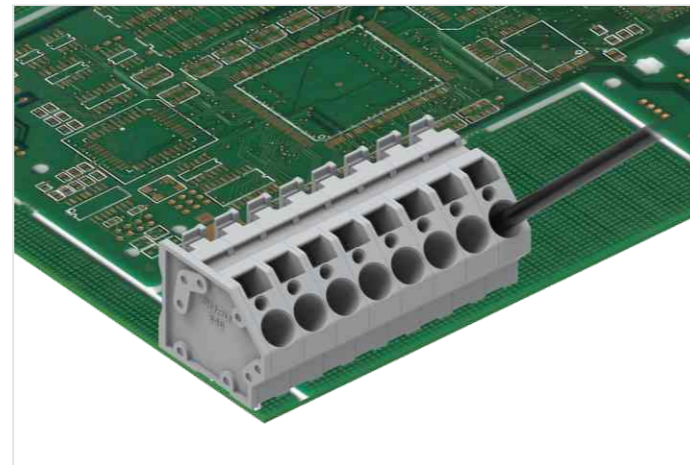
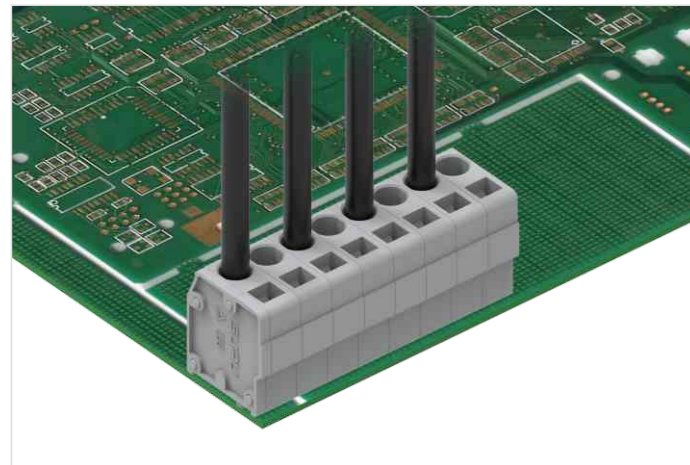
Pin间距	订货号 Order No.	4251XX	4351XX 4351XX/050	4355XX 4355XX/030	4381XX 4381XX/050	4501XX 4501XX/010 4501XX/030 4501XX/050	45015X 45015X/010 45015X/030	45025X 45025X/110	45035X	4506XX 4506XX/010 4506XX/030 4506XX/050
		2.5	4252XX	●						
2.5	4253XX	●								
2.5	4254XX	●								
3.5	4352XX		●							
3.5	4353XX		●							
3.5	4354XX 4354XX/010		●	●						
3.5	4355XX 4355XX/030		●	●						
3.5	4358XX		●							
3.81	4382XX				●					
3.81	4383XX				●					
3.81	4384XX 4384XX/010				●					
5.0	4502XX-XXD 4502XX/110					●				
5.0	4503XX-XXD					●	●			
5.0	4504XX 4504XX/010 4504XX/030					●	●	●	●	
5.0	4504XX/060					●				
5.0	4507XX-XXD 4507XX/110									●
5.0	4508XX									●
5.0	4509XX 4509XX/010 4509XX/030									●
5.0	4509XX/060									●
5.08	4582XX-XXD									
5.08	4583XX-XXD									
5.08	4584XX 4584XX/010 4584XX/030									●
5.08	4584XX/060									●
7.5	4752XX-XXD									●
7.5	4753XX-XXD									●

45065X 45065X/010 45065X/030	45075X 45075X/110	45085X	4581XX 4581XX/010 4581XX/030 4581XX/050	4751XX 4751XX/010 4751XX/030 4751XX/050	47525X	47535X	4756XX 4756XX/010 4756XX/030 4756XX/050	47575X	47585X	4781XX 4781XX/010 4781XX/030 4781XX/050
5.0	5.0	5.0	5.08	7.5	7.5	7.5	7.5	7.5	7.5	7.62
●										
●	●	●								
			●							
			●							
			●							
			●							
				●						
				●						

MCS连接器选型配比表
MCS connector selection ratio table

订货号 Order No.	Pin 间距	4251XX	4351XX 4351XX/050	4355XX 4355XX/030	4381XX 4381XX/050	4501XX 4501XX/010 4501XX/030 4501XX/050	45015X 45015X/010 45015X/030	45025X 45025X/110	45035X	4506XX 4506XX/010 4506XX/030 4506XX/050
4754XX 4754XX/010 4754XX/030	7.5									
4754XX/060	7.5									
4757XX-XXD	7.5									
4758XX-XXD	7.5									
4759XX 4759XX/010 4759XX/030	7.5									
4759XX/060	7.5									
4782XX-XXD	7.62									
4783XX-XXD	7.62									
4784XX 4784XX/010 4784XX/030	7.62									
4784XX/060	7.62									

45065X 45065X/010 45065X/030	45075X 45075X/110	45085X	4581XX 4581XX/010 4581XX/030 4581XX/050	4751XX 4751XX/010 4751XX/030 4751XX/050	47525X	47535X	4756XX 4756XX/010 4756XX/030 4756XX/050	47575X	47585X	4781XX 4781XX/010 4781XX/030 4781XX/050
5.0	5.0	5.0	5.08	7.5	7.5	7.5	7.5	7.5	7.5	7.62

				●	●	●				
				●						
							●			
							●			
							●	●	●	
							●			
										●
										●
										●
										●

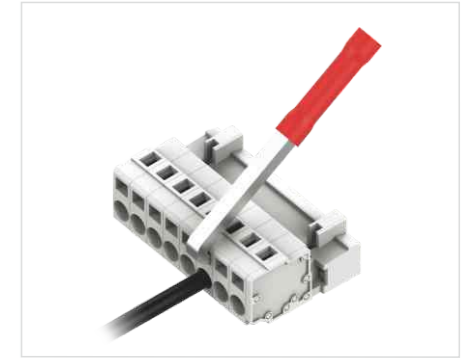
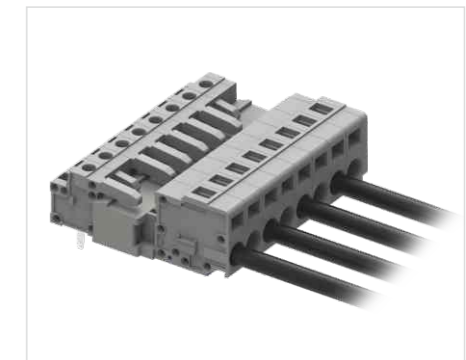
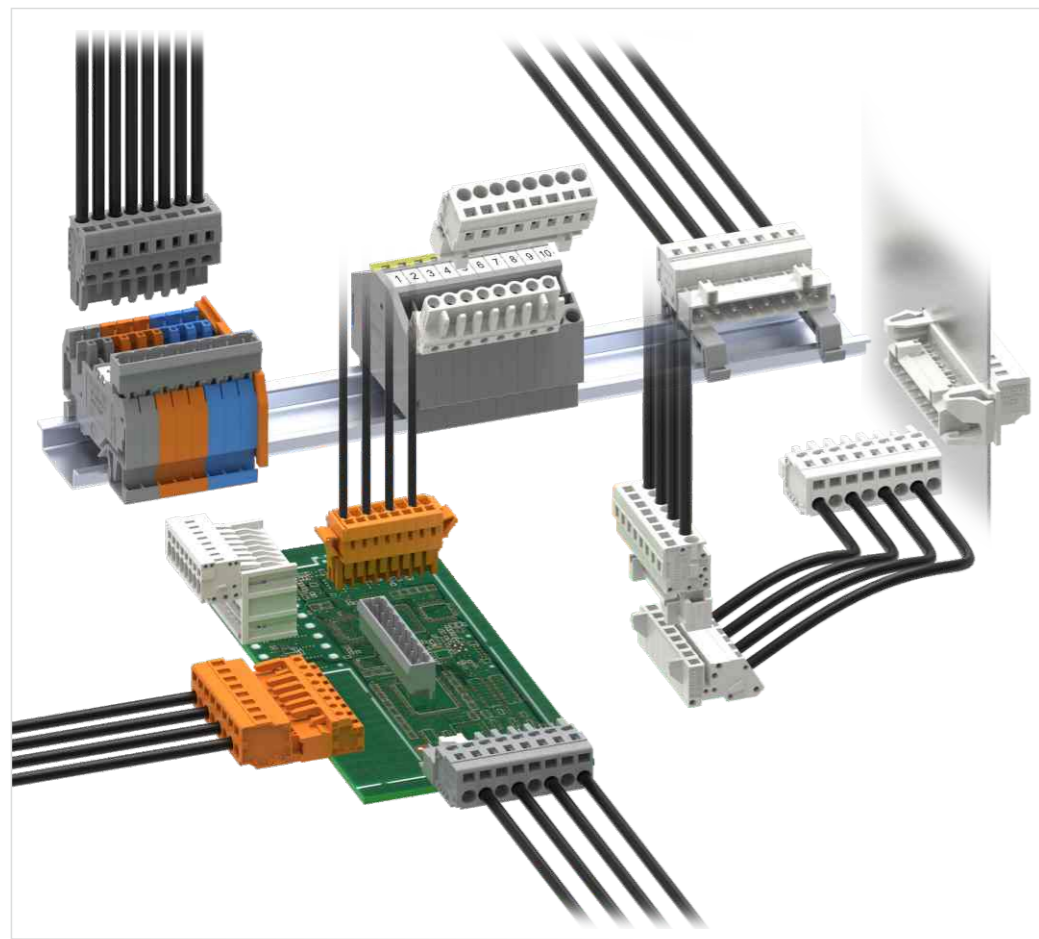

5.0mm间距焊针插座 5.0mm Solder pin

产品信息Product Information		IEC		UL		产品信息Product Information		订货号/通道数 Order No./Poles No.		订货号/通道数 Order No./Poles No.	
IEC/UL数据 IEC/UL Data						锁线螺钉 Locking crew	-	4502XX	2-24	4502XX-04D	2-24
额定电流 Rated current	[A]	12	15	扭矩 Torque	[N·m]	-	4502XX/110	2-24	4502XX-05D	2-24	
额定电压 Rated voltage	[V]	320	300	固定螺钉 Fixed screw	-	4502XX-01D	2-24	4502XX-06D	2-24		
硬导线截面积 Solid	[mm ²][AWG]	-	-	扭矩 Torque	[N·m]	-	4502XX-03D	2-24	4503XX	2-24	
柔性导线截面积 Flexible	[mm ²][AWG]	-	-	剥线长度 Strip length	[mm]	-					
额定冲击电压 Rated impulse voltage	[KV]	4.0	-								

5.0mm间距焊针插座 5.0mm Solder pin

产品信息Product Information		IEC		UL		产品信息Product Information		订货号/通道数 Order No./Poles No.		附件Accessory	
IEC/UL数据 IEC/UL Data						锁线螺钉 Locking crew	-	45015X	2-24	450012	
额定电流 Rated current	[A]	12	15	扭矩 Torque	[N·m]	-	45015X/010	2-24	450023		
额定电压 Rated voltage	[V]	320	300	固定螺钉 Fixed screw	-	45015X/030	2-24	450014			
硬导线截面积 Solid	[mm ²][AWG]	0.2-2.5	28-12	扭矩 Torque	[N·m]	-		450012			
柔性导线截面积 Flexible	[mm ²][AWG]	0.2-2.5	28-12	剥线长度 Strip length	[mm]	8-9		22533X			
额定冲击电压 Rated impulse voltage	[KV]	4.0	-								

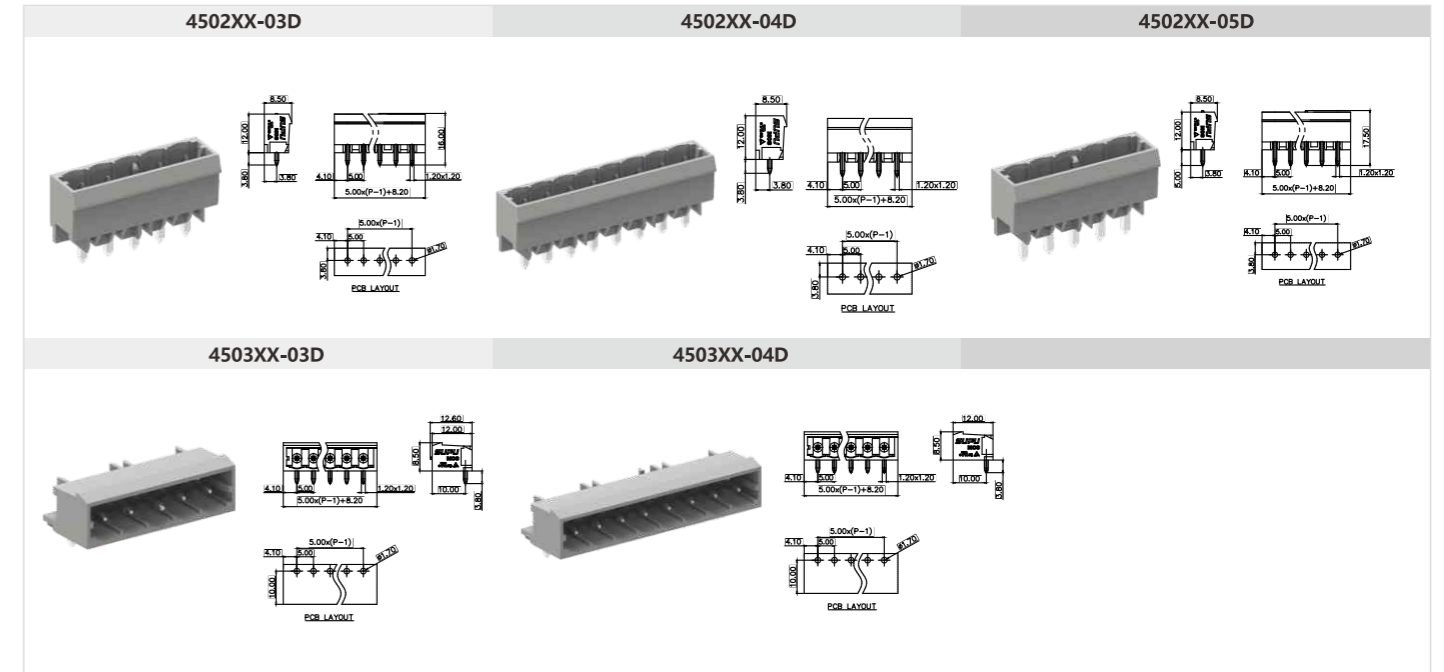
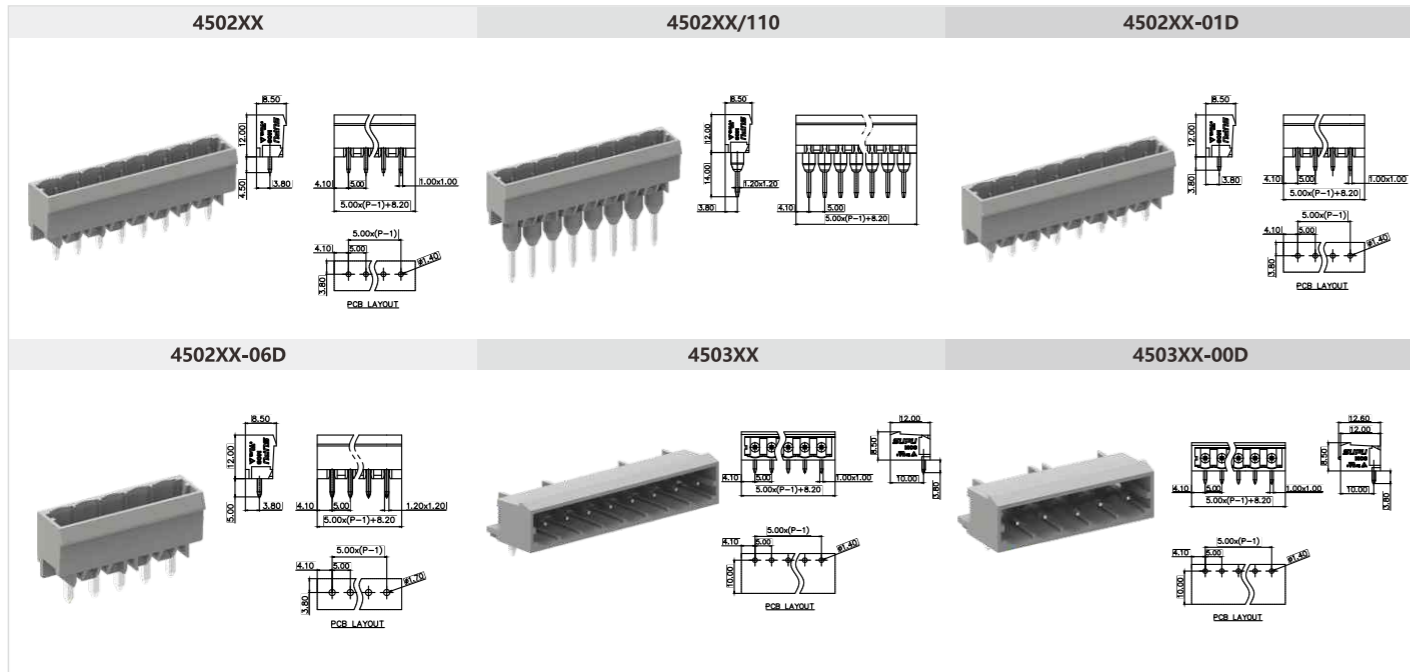

5.0mm间距针型连接器 5.0mm Male connector with spring-cage clamp

产品信息Product Information		IEC		UL		产品信息Product Information		订货号/通道数 Order No./Poles No.		附件Accessory	
IEC/UL数据 IEC/UL Data						锁线螺钉 Locking crew	-	4504XX	2-24	45097X	450012
额定电流 Rated current	[A]	12	15	扭矩 Torque	[N·m]	-	4504XX/010	2-24	4505XX	22533X	
额定电压 Rated voltage	[V]	320	300	固定螺钉 Fixed screw	-	4504XX/030	2-24	450021			
硬导线截面积 Solid	[mm ²][AWG]	0.2-2.5	28-12	扭矩 Torque	[N·m]	-	4504XX/060	2-24	450023		
柔性导线截面积 Flexible	[mm ²][AWG]	0.2-2.5	28-12	剥线长度 Strip length	[mm]	8-9		450014			
额定冲击电压 Rated impulse voltage	[KV]	4.0	-								

5.0mm间距孔型弯头连接器 5.0mm Female right head connector with spring-cage clamp

产品信息Product Information		IEC		UL		产品信息Product Information		订货号/通道数 Order No./Poles No.		附件Accessory	
IEC/UL数据 IEC/UL Data						锁线螺钉 Locking crew	-	45015X	2-24	450021	
额定电流 Rated current	[A]	12	15	扭矩 Torque	[N·m]	-	45015X/010	2-24	450023		
额定电压 Rated voltage	[V]	320	300	固定螺钉 Fixed screw	-	45015X/030	2-24	450014			
硬导线截面积 Solid	[mm ²][AWG]	0.2-2.5	28-12	扭矩 Torque	[N·m]	-		450012			
柔性导线截面积 Flexible	[mm ²][AWG]	0.2-2.5	28-12	剥线长度 Strip length	[mm]	8-9		22533X			
额定冲击电压 Rated impulse voltage	[KV]	4.0	-								

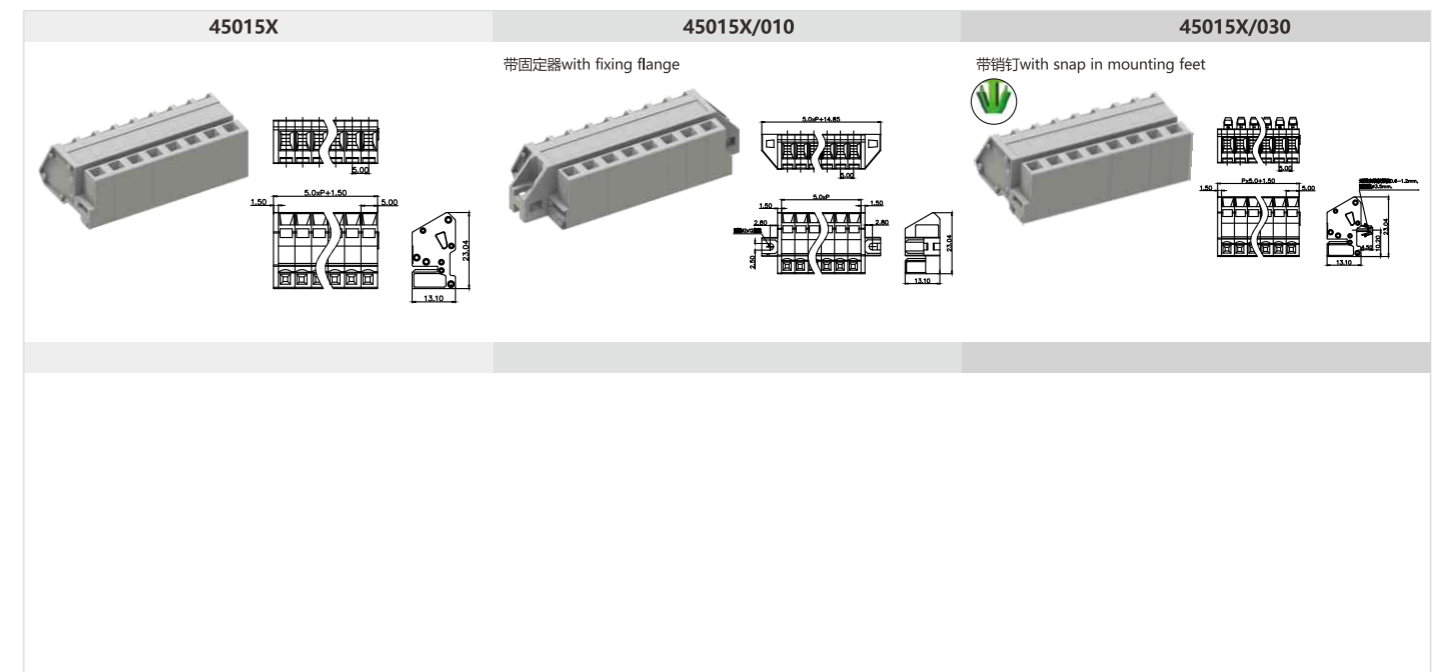
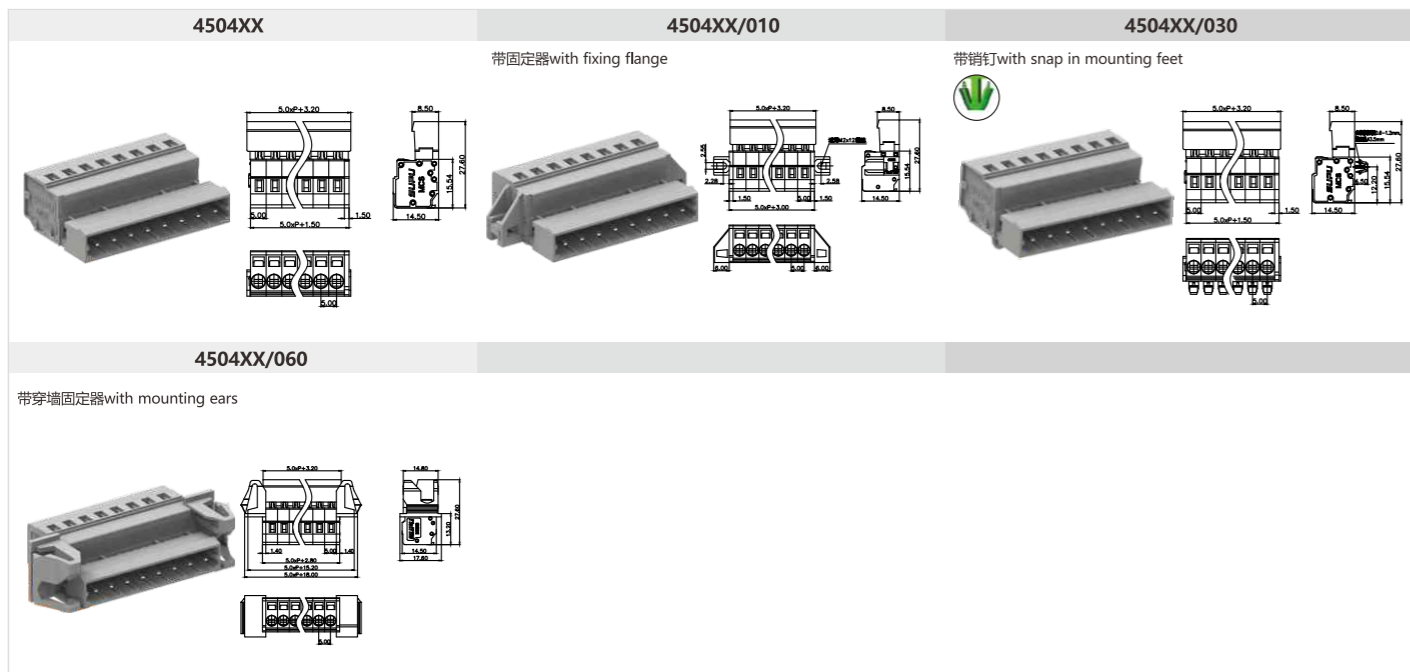

5.0mm间距孔型插头带焊针 5.0mm Female connector with spring-cage clamp with solder pin

产品信息Product Information				锁线螺钉 Locking crew		订货号/通道数 Order No./Poles No.		附件Accessory	
IEC/UL数据 IEC/UL Data	IEC	UL		-	45025X	2-24			
额定电流 Rated current [A]	12	15		-	45025X/110	2-24			
额定电压 Rated voltage [V]	320	300		-	45035X	2-24			
硬导线截面积 Solid [mm ²][AWG]	-	-		-					
柔性导线截面积 Flexible [mm ²][AWG]	-	-		-					
额定冲击电压 Rated impulse voltage [KV]	4.0	-		-					

45025X	45025X/110	45035X
直针型vertical solder pin	长直针型long solder pin	弯针型right angle solder pin

5.0mm间距穿墙式连接器 5.0mm Through-wall connector

产品信息Product Information				锁线螺钉 Locking crew		订货号/通道数 Order No./Poles No.		附件Accessory	
IEC/UL数据 IEC/UL Data	IEC	UL		-	45046X	2-24	45097X	450012	
额定电流 Rated current [A]	12	15		-	45046X/010	2-24	4505XX	22533X	
额定电压 Rated voltage [V]	320	300		-	45043X	2-24	450021		
硬导线截面积 Solid [mm ²][AWG]	0.2-2.5	28-12		-	45043X/010	2-24	450023		
柔性导线截面积 Flexible [mm ²][AWG]	0.2-2.5	28-12		-			450014		
额定冲击电压 Rated impulse voltage [KV]	4.0	-		-					

45046X	45046X/010
直针型vertical solder pin	直针型带固定器 vertical solder pin with fixing flange
45043X	45043X/010
弯针型with fixing flange	弯针型带固定器 right angle solder pin with fixing flange

5.0mm间距孔型连接器(防错) 5.0mm Female connectors(protected against mismatching)

产品信息Product Information				锁线螺钉 Locking crew		订货号/通道数 Order No./Poles No.		附件Accessory	
IEC/UL数据 IEC/UL Data	IEC	UL		-	4506XX	2-24	45097X	450012	
额定电流 Rated current [A]	12	15		-	4506XX/010	2-24	4505XX	22533X	
额定电压 Rated voltage [V]	320	300		-	4506XX/030	2-24	450021		
硬导线截面积 Solid [mm ²][AWG]	0.2-2.5	28-12		-	4506XX/050	2-24	450023		
柔性导线截面积 Flexible [mm ²][AWG]	0.2-2.5	28-12		-			450014		
额定冲击电压 Rated impulse voltage [KV]	4.0	-		-					

4506XX	4506XX/010	4506XX/030
	带固定器with fixing flange	带销钉with snap in mounting feet
4506XX/050		
带卡接钩with locking device		

5.0mm间距针型连接器(防错) 5.0mm Male connector with spring-cage clamp (protected against mismatching)

产品信息Product Information				锁线螺钉 Locking crew		订货号/通道数 Order No./Poles No.		附件Accessory	
IEC/UL数据 IEC/UL Data	IEC	UL		-	4509XX	2-24	45097X	450012	
额定电流 Rated current [A]	12	15		-	4509XX/010	2-24	4505XX	22533X	
额定电压 Rated voltage [V]	320	300		-	4509XX/030	2-24	450021		
硬导线截面积 Solid [mm ²][AWG]	0.2-2.5	28-12		-	45043X/010	2-24	450023		
柔性导线截面积 Flexible [mm ²][AWG]	0.2-2.5	28-12		-			450014		
额定冲击电压 Rated impulse voltage [KV]	4.0	-		-					

4509XX	4509XX/010	4509XX/030
	带固定器with fixing flange	带销钉with snap in mounting feet
4509XX/060		
带穿墙固定器with mounting ears		

5.0mm间距焊针插座(防错) 5.0mm Solder pin(protected against mismatching)

产品信息Product Information			产品信息Product Information			订货号/通道数 Order No./Poles No.		订货号/通道数 Order No./Poles No.	
IEC/UL数据 IEC/UL Data	IEC	UL	锁线螺钉 Locking crew	-	4507XX	2-24	4507XX-03D	2-24	
额定电流 Rated current	[A]	12 15	扭矩 Torque	[N·m]	4507XX/110	2-24	4507XX-04D	2-24	
额定电压 Rated voltage	[V]	320 300	固定螺钉 Fixed screw	-	4507XX-00D	2-24	4507XX-05D	2-24	
硬导线截面积 Solid	[mm ²][AWG]	-	扭矩 Torque	[N·m]	4507XX-01D	2-24	4507XX-06D	2-24	
柔性导线截面积 Flexible	[mm ²][AWG]	-	剥线长度 Strip length	[mm]					
额定冲击电压 Rated impulse voltage	[KV]	4.0							

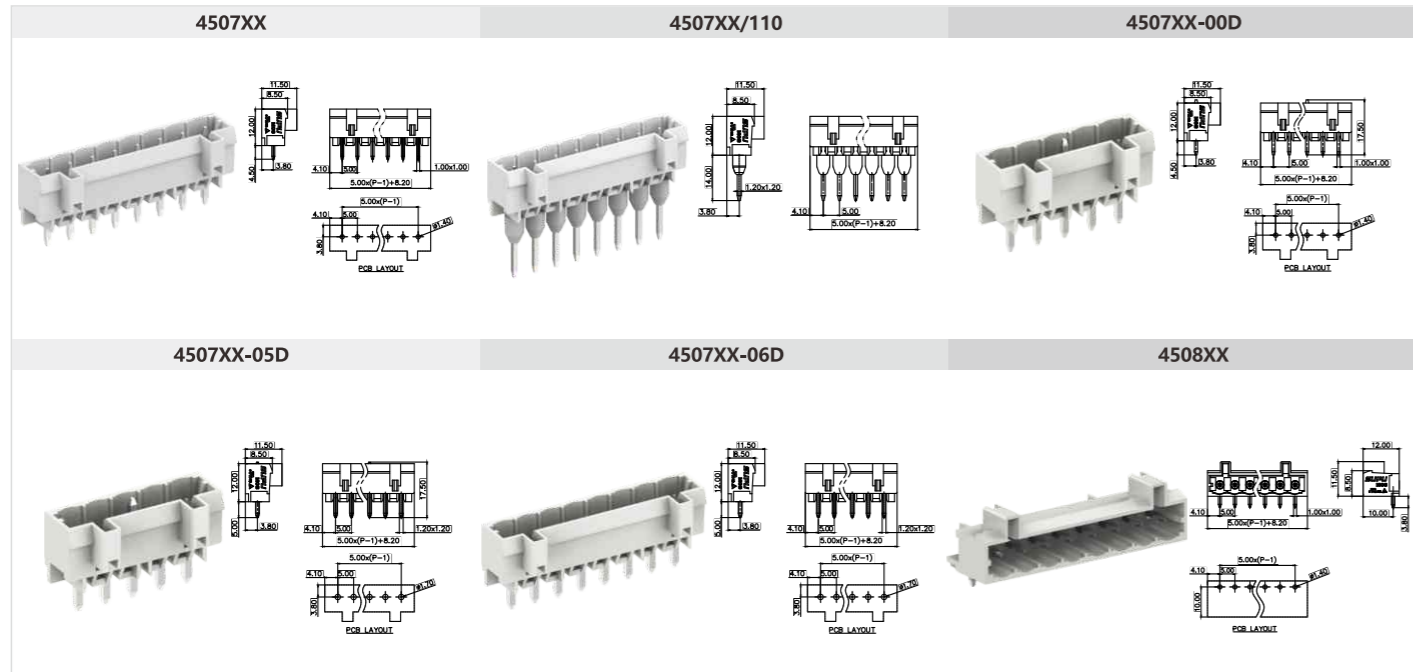

5.0mm间距焊针插座(防错) 5.0mm Solder pin(protected against mismatching)

订货号/通道数 Order No./Poles No.		附件Accessory	
4508XX	2-24	450015	

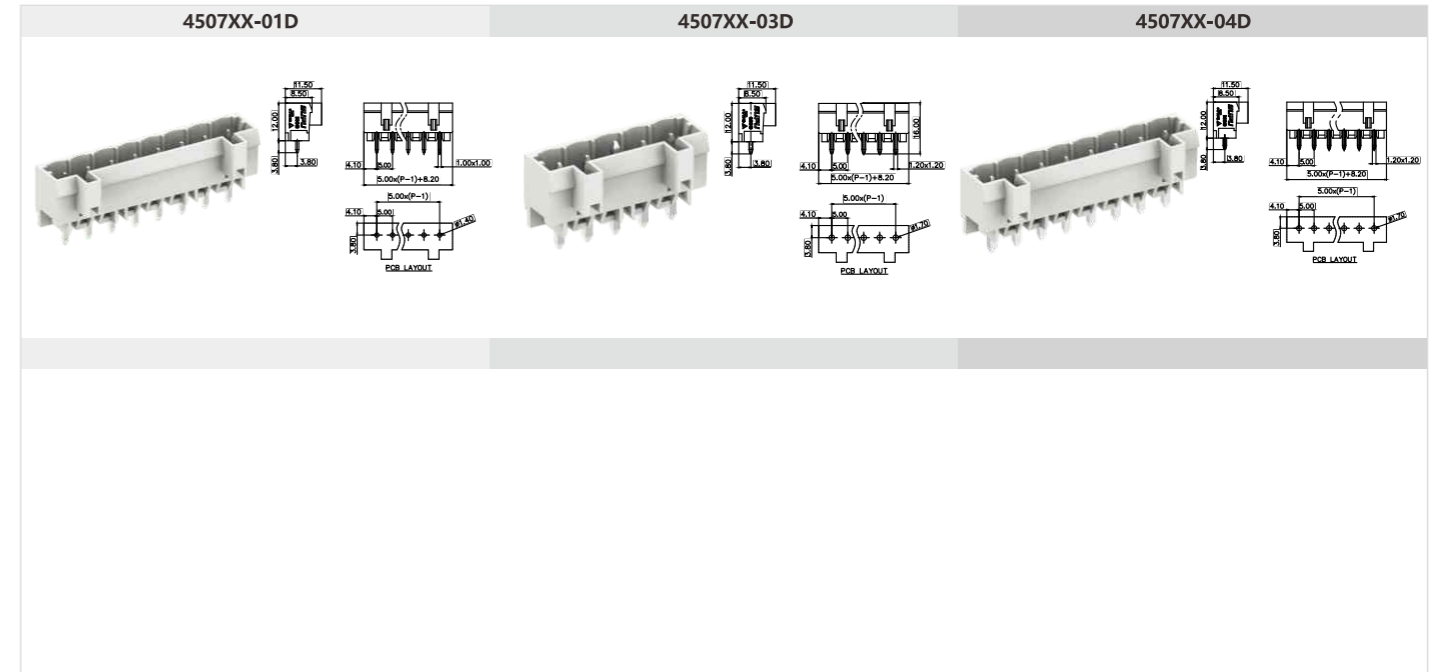

5.0mm间距孔型弯头连接器(防错) 5.0mm Female right head connector with spring-cage clamp (protected against mismatching)

产品信息Product Information			产品信息Product Information			订货号/通道数 Order No./Poles No.		附件Accessory	
IEC/UL数据 IEC/UL Data	IEC	UL	锁线螺钉 Locking crew	-	45065X	2-24	450021		
额定电流 Rated current	[A]	12 15	扭矩 Torque	[N·m]	45065X/010	2-24	450023		
额定电压 Rated voltage	[V]	320 300	固定螺钉 Fixed screw	-	45065X/030	2-24	450014		
硬导线截面积 Solid	[mm ²][AWG]	0.2-2.5 28-12	扭矩 Torque	[N·m]			450012		
柔性导线截面积 Flexible	[mm ²][AWG]	0.2-2.5 28-12	剥线长度 Strip length	[mm]			22533X		
额定冲击电压 Rated impulse voltage	[KV]	4.0							

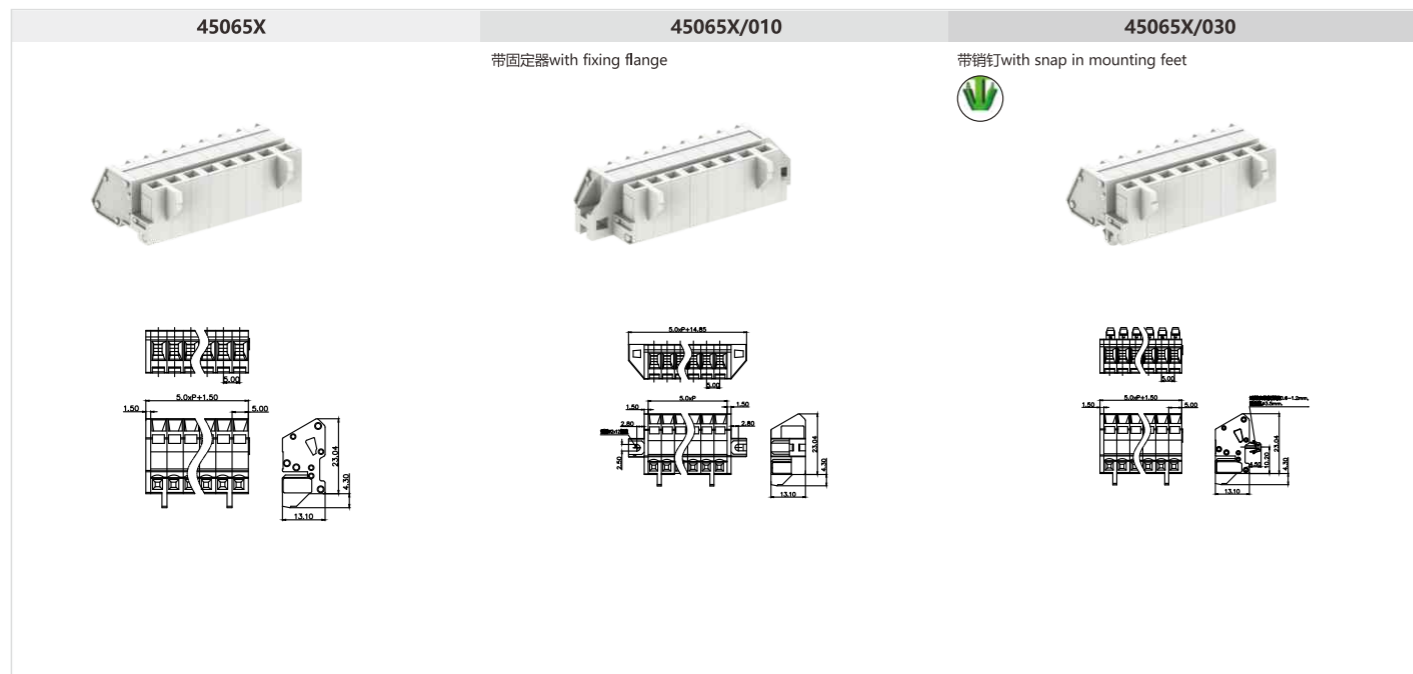

5.0mm间距孔型插头带焊针(防错) 5.0mm Female connector with spring-cage clamp with solder pin(protected against mismatching)

产品信息Product Information			产品信息Product Information			订货号/通道数 Order No./Poles No.		附件Accessory	
IEC/UL数据 IEC/UL Data	IEC	UL	锁线螺钉 Locking crew	-	45075X	2-24	45075X		
额定电流 Rated current	[A]	12 15	扭矩 Torque	[N·m]	45075X/110	2-24	45075X/110		
额定电压 Rated voltage	[V]	320 300	固定螺钉 Fixed screw	-	45085X	2-24	45085X		
硬导线截面积 Solid	[mm ²][AWG]	-	扭矩 Torque	[N·m]					
柔性导线截面积 Flexible	[mm ²][AWG]	-	剥线长度 Strip length	[mm]					
额定冲击电压 Rated impulse voltage	[KV]	4.0							

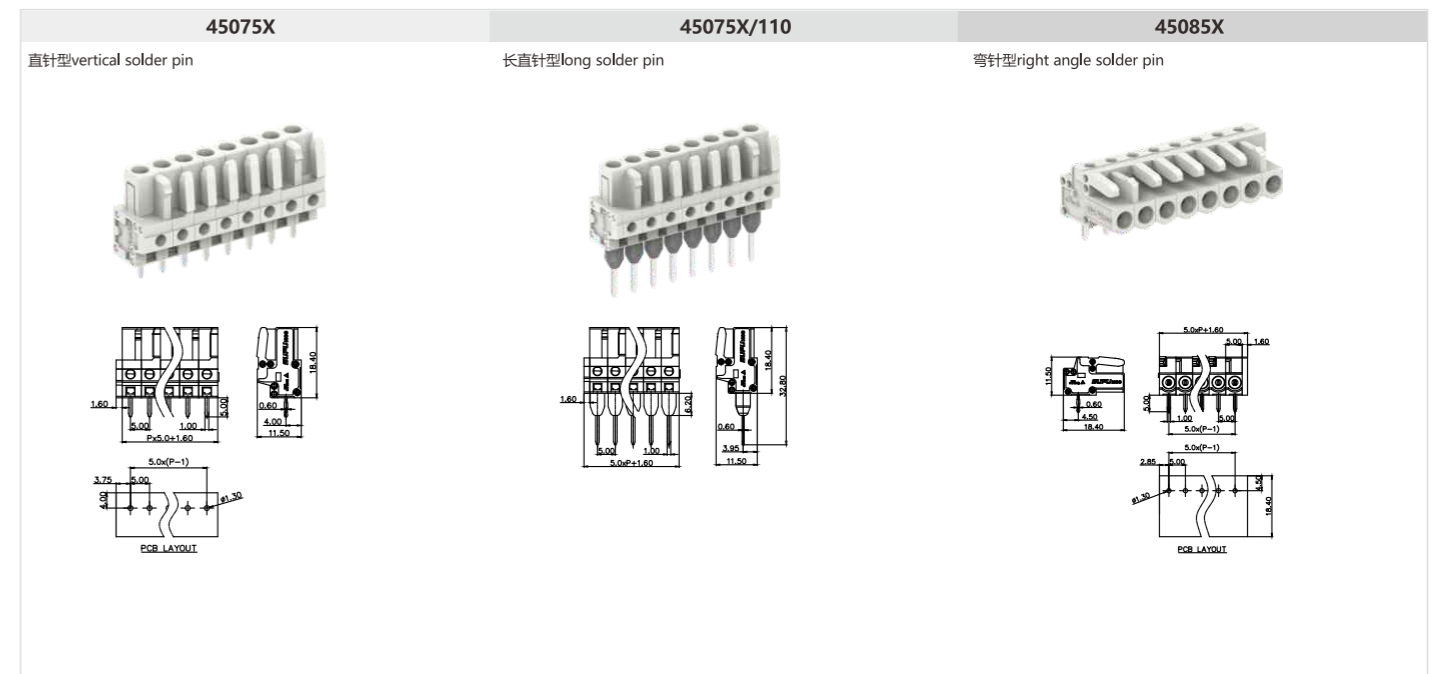

5.08mm间距孔型连接器 5.08mm Female connectors

产品信息Product Information				锁线螺钉 Locking crew		订货号/通道数 Order No./Poles No.		附件Accessory	
IEC/UL数据 IEC/UL Data	IEC	UL		-	4581XX	2-24	45897X		
额定电流 Rated current	[A]	12	15	扭矩 Torque [N·m]	-	4581XX/010	2-24	4585XX	
额定电压 Rated voltage	[V]	320	300	固定螺钉 Fixed screw	-	4506XX/030	2-24	450021	
硬导线截面积 Solid [mm ²][AWG]	0.2-2.5	28-12		扭矩 Torque [N·m]	-	4506XX/050	2-24	450023	
柔性导线截面积 Flexible [mm ²][AWG]	0.2-2.5	28-12		剥线长度 Strip length [mm]	8-9			450014	
额定冲击电压 Rated impulse voltage	[KV]	4.0	-						

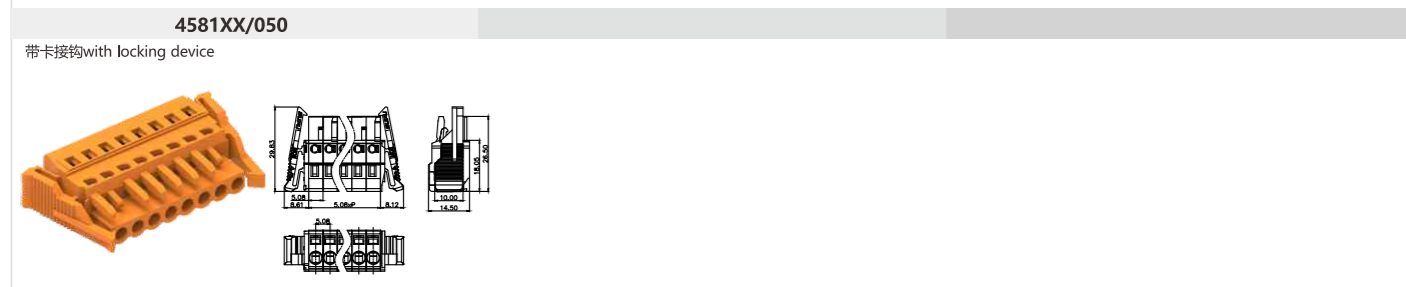
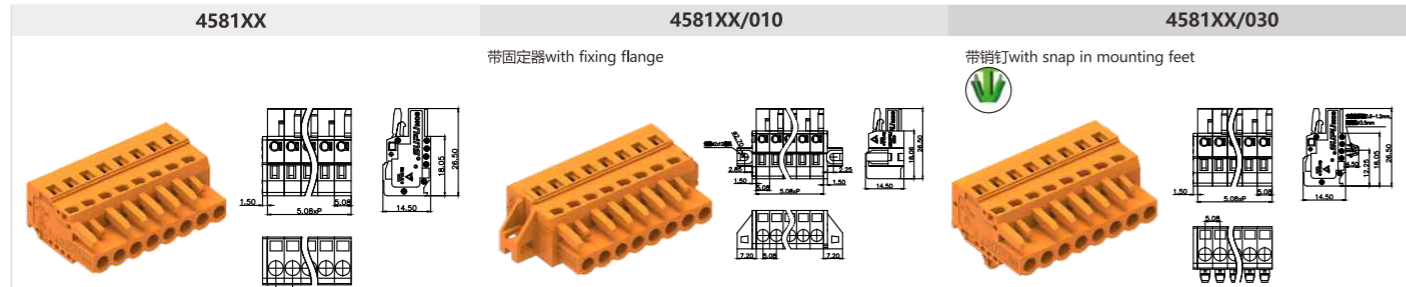

5.08mm间距针型连接器 5.08mm Male connector with spring-cage clamp

产品信息Product Information				锁线螺钉 Locking crew		订货号/通道数 Order No./Poles No.		附件Accessory	
IEC/UL数据 IEC/UL Data	IEC	UL		-	4584XX	2-24	45897X		
额定电流 Rated current	[A]	12	15	扭矩 Torque [N·m]	-	4584XX/010	2-24	4585XX	
额定电压 Rated voltage	[V]	320	300	固定螺钉 Fixed screw	-	4584XX/030	2-24	450021	
硬导线截面积 Solid [mm ²][AWG]	0.2-2.5	28-12		扭矩 Torque [N·m]	-	4584XX/060	2-24	450023	
柔性导线截面积 Flexible [mm ²][AWG]	0.2-2.5	28-12		剥线长度 Strip length [mm]	8-9			450014	
额定冲击电压 Rated impulse voltage	[KV]	4.0	-						

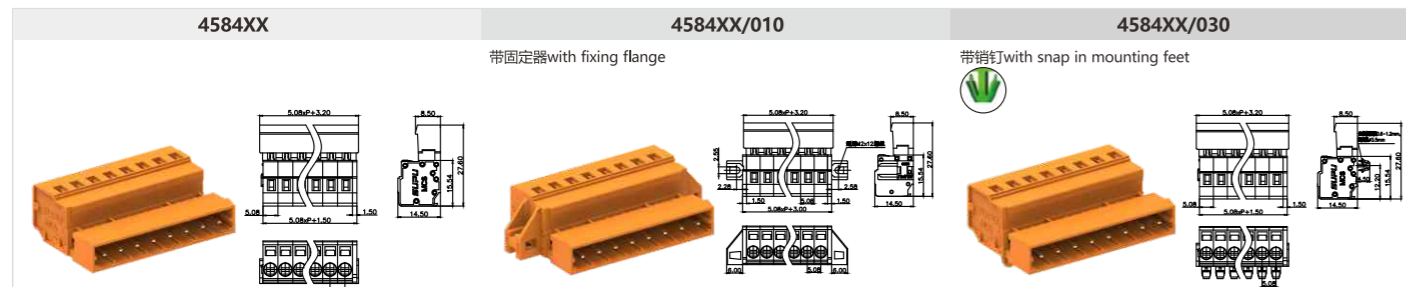

5.08mm间距焊针插座 5.08mm Solder pin

产品信息Product Information				锁线螺钉 Locking crew		订货号/通道数 Order No./Poles No.		附件Accessory	
IEC/UL数据 IEC/UL Data	IEC	UL		-	4582XX	2-24	450015		
额定电流 Rated current	[A]	12	15	扭矩 Torque [N·m]	-	4582XX-01D	2-24		
额定电压 Rated voltage	[V]	320	300	固定螺钉 Fixed screw	-	4583XX	2-24		
硬导线截面积 Solid [mm ²][AWG]	-	-	-	扭矩 Torque [N·m]	-	4583XX-00D	2-24		
柔性导线截面积 Flexible [mm ²][AWG]	-	-	-	剥线长度 Strip length [mm]	-				
额定冲击电压 Rated impulse voltage	[KV]	4.0	-						

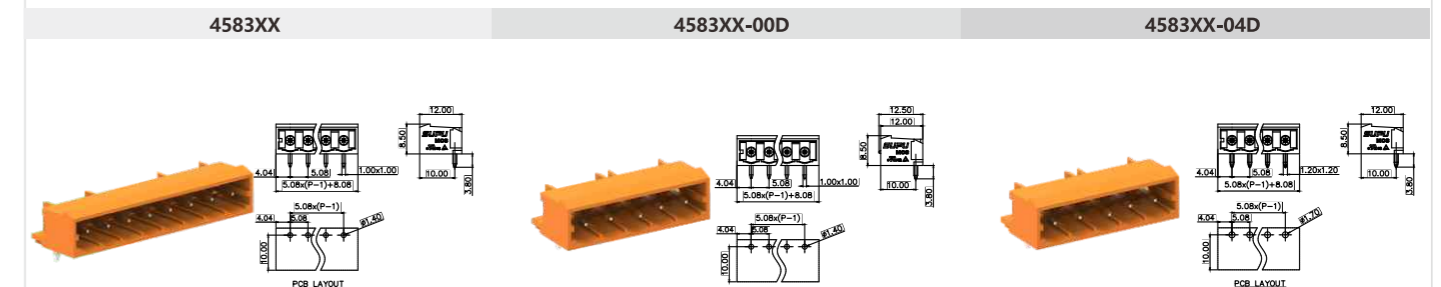
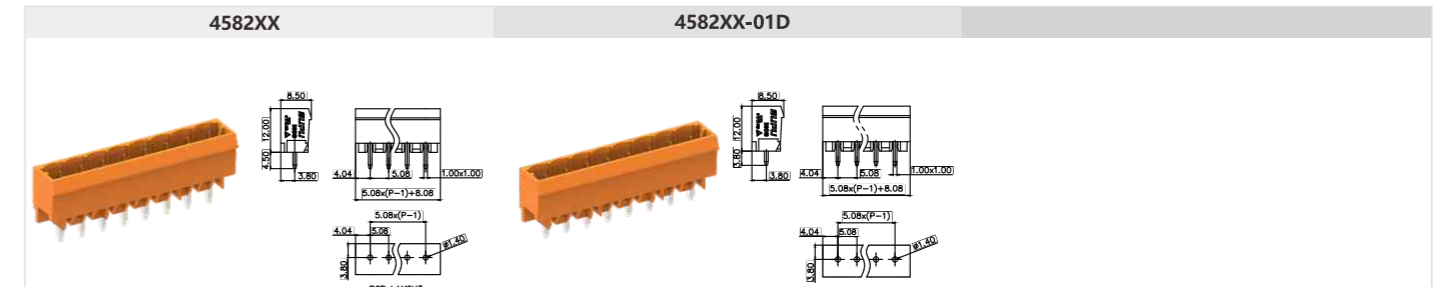

5.08mm间距孔型插头带焊针 5.08mm Female connector with spring-cage clamp with solder pin

产品信息Product Information				锁线螺钉 Locking crew		订货号/通道数 Order No./Poles No.		附件Accessory	
IEC/UL数据 IEC/UL Data	IEC	UL		-	45825X	2-24			
额定电流 Rated current	[A]	12	15	扭矩 Torque [N·m]	-	45835X	2-24		
额定电压 Rated voltage	[V]	320	300	固定螺钉 Fixed screw	-				
硬导线截面积 Solid [mm ²][AWG]	-	-	-	扭矩 Torque [N·m]	-				
柔性导线截面积 Flexible [mm ²][AWG]	-	-	-	剥线长度 Strip length [mm]	-				
额定冲击电压 Rated impulse voltage	[KV]	4.0	-						

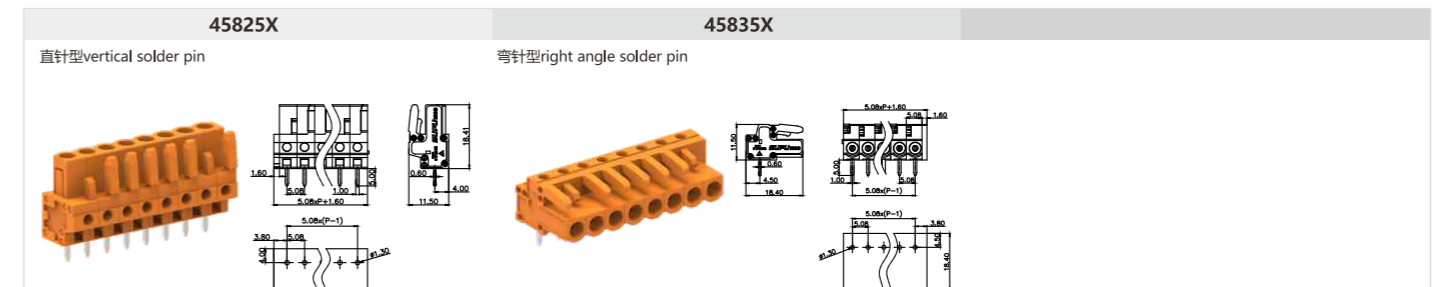

5.08mm间距穿墙式连接器 5.08mm Through-wall connector

产品信息Product Information				产品信息Product Information				附件Accessory			
IEC/UL数据 IEC/UL Data		IEC	UL	锁线螺钉 Locking crew	-	45846X	2-24	45897X			
额定电流 Rated current	[A]	12	15	扭矩 Torque	[N·m]	45846X/010	2-24	4585XX			
额定电压 Rated voltage	[V]	320	300	固定螺钉 Fixed screw	-	45843X	2-24	450021			
硬导线截面积 Solid	[mm ²][AWG]	0.2-2.5	28-12	扭矩 Torque	[N·m]	45843X/010	2-24	450023			
柔性导线截面积 Flexible	[mm ²][AWG]	0.2-2.5	28-12	剥线长度 Strip length	[mm]			450014			
额定冲击电压 Rated impulse voltage	[KV]	4.0	-								

45846X	45846X/010
直针型vertical solder pin 	直针型带固定器 vertical solder pin with fixing flange
45843X	45843X/010
弯针型right angle solder pin 	弯针型带固定器 right angle solder pin with fixing flange

7.5mm间距孔型连接器 7.5mm Female connectors

产品信息Product Information				产品信息Product Information				附件Accessory			
IEC/UL数据 IEC/UL Data		IEC	UL	锁线螺钉 Locking crew	-	4751XX	2-24	45097X			
额定电流 Rated current	[A]	16	15	扭矩 Torque	[N·m]	4751XX/010	2-24	4755XX			
额定电压 Rated voltage	[V]	500	300	固定螺钉 Fixed screw	-	4751XX/030	2-24	450021			
硬导线截面积 Solid	[mm ²][AWG]	0.2-2.5	28-14	扭矩 Torque	[N·m]	4751XX/050	2-24	450023			
柔性导线截面积 Flexible	[mm ²][AWG]	0.2-2.5	28-14	剥线长度 Strip length	[mm]	8-9		450014			
额定冲击电压 Rated impulse voltage	[KV]	6.0	-								

4751XX	4751XX/010	4751XX/030
	带固定器with fixing flange 	带螺钉with snap in mounting feet
4751XX/050		
带卡接钩with locking device 		

7.5mm间距焊针插座 7.5mm Solder pin

产品信息Product Information				产品信息Product Information				附件Accessory			
IEC/UL数据 IEC/UL Data		IEC	UL	锁线螺钉 Locking crew	-	4752XX	2-24	4752XX-06D	2-24		
额定电流 Rated current	[A]	12	15	扭矩 Torque	[N·m]	4752XX-03D	2-24	4753XX	2-24		
额定电压 Rated voltage	[V]	500	300	固定螺钉 Fixed screw	-	4752XX-04D	2-24	4753XX-03D	2-24		
硬导线截面积 Solid	[mm ²][AWG]	-	-	扭矩 Torque	[N·m]	4752XX-05D	2-24	4753XX-04D	2-24		
柔性导线截面积 Flexible	[mm ²][AWG]	-	-	剥线长度 Strip length	[mm]	-					
额定冲击电压 Rated impulse voltage	[KV]	6.0	-								

4752XX	4507XX-03D	4752XX-04D
4753XX	4753XX-03D	4753XX-04D

附件Accessory			
475015			

4752XX-05D	4752XX-06D

7.5mm间距针型连接器 7.5mm Male connector with spring-cage clamp

产品信息Product Information				锁线螺钉 Locking crew		订货号/通道数 Order No./Poles No.		附件Accessory	
IEC/UL数据 IEC/UL Data	IEC	UL		-	4754XX	2-24	45097X		
额定电流 Rated current	[A]	16	15	扭矩 Torque	[N·m]	-	4754XX/010	2-24	4755XX
额定电压 Rated voltage	[V]	500	300	固定螺钉 Fixed screw	-	4754XX/030	2-24	450021	
硬导线截面积 Solid	[mm ²][AWG]	0.2-2.5	28-14	扭矩 Torque	[N·m]	-	4754XX/060	2-24	450023
柔性导线截面积 Flexible	[mm ²][AWG]	0.2-2.5	28-14	剥线长度 Strip length	[mm]	8-9			450014
额定冲击电压 Rated impulse voltage	[KV]	6.0	-						

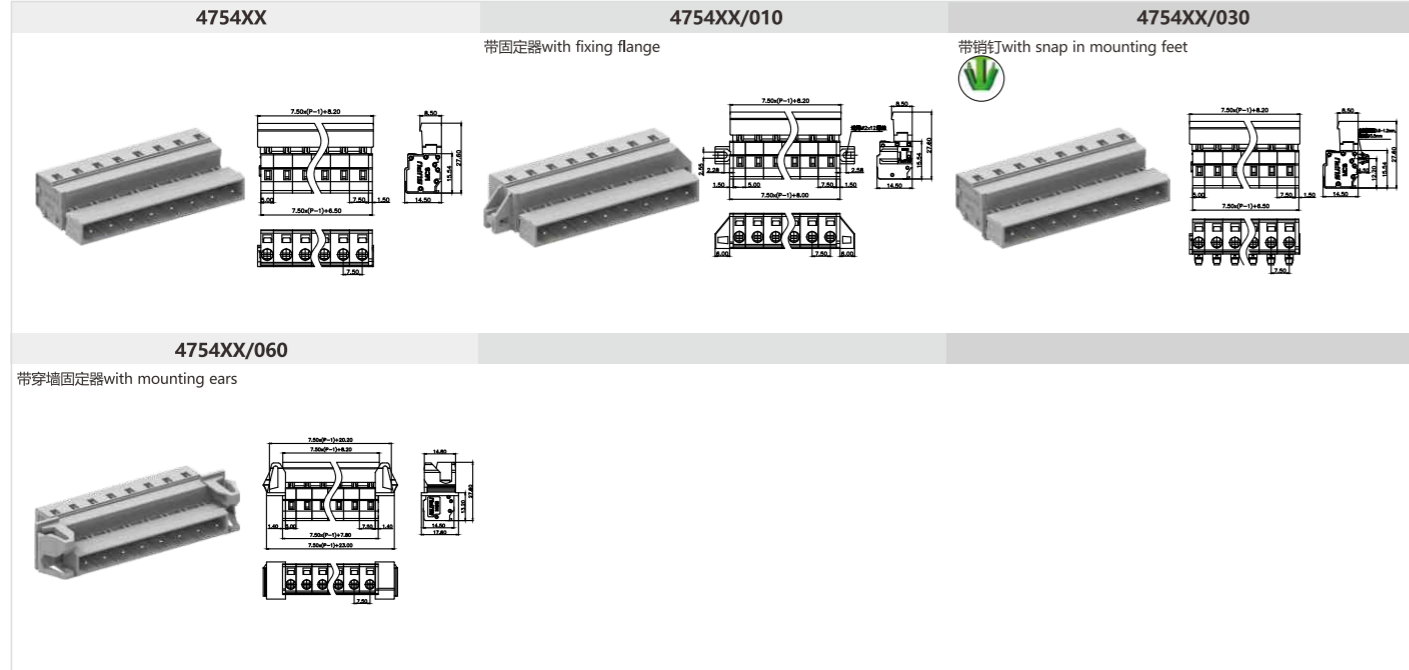

7.5mm间距孔型插头带焊针 7.5mm Female connector with spring-cage clamp with solder pin

产品信息Product Information				锁线螺钉 Locking crew		订货号/通道数 Order No./Poles No.		附件Accessory	
IEC/UL数据 IEC/UL Data	IEC	UL		-	47525X	2-24	45097X		
额定电流 Rated current	[A]	16	15	扭矩 Torque	[N·m]	-	47535X	2-24	
额定电压 Rated voltage	[V]	500	300	固定螺钉 Fixed screw	-				
硬导线截面积 Solid	[mm ²][AWG]	-	-	扭矩 Torque	[N·m]	-			
柔性导线截面积 Flexible	[mm ²][AWG]	-	-	剥线长度 Strip length	[mm]	-			
额定冲击电压 Rated impulse voltage	[KV]	6.0	-						

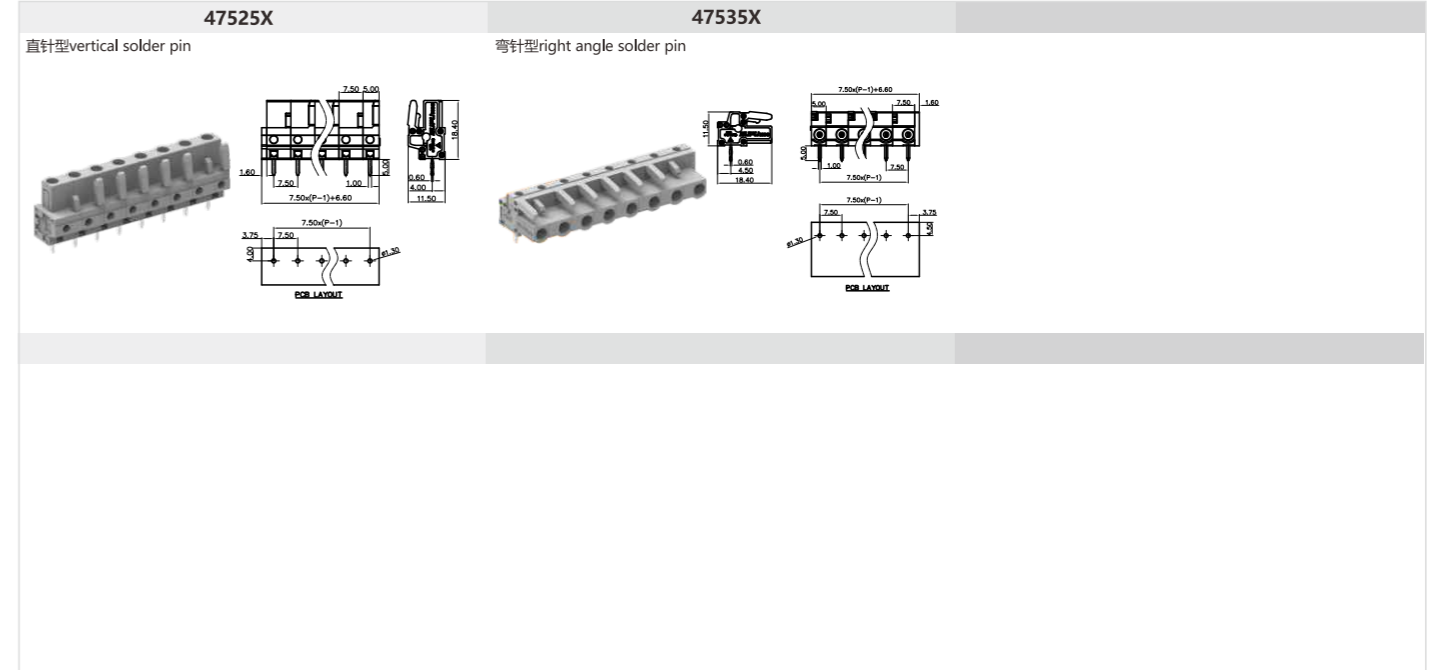

7.5mm间距穿墙式连接器 5mm Through-wall connector

产品信息Product Information				锁线螺钉 Locking crew		订货号/通道数 Order No./Poles No.		附件Accessory	
IEC/UL数据 IEC/UL Data	IEC	UL		-	47546X	2-24	45097X		
额定电流 Rated current	[A]	16	15	扭矩 Torque	[N·m]	-	47546X/010	2-24	4755XX
额定电压 Rated voltage	[V]	500	300	固定螺钉 Fixed screw	-	47543X	2-24	450021	
硬导线截面积 Solid	[mm ²][AWG]	0.2-2.5	28-14	扭矩 Torque	[N·m]	-	47543X/010	2-24	450023
柔性导线截面积 Flexible	[mm ²][AWG]	0.2-2.5	28-14	剥线长度 Strip length	[mm]	8-9			450014
额定冲击电压 Rated impulse voltage	[KV]	6.0	-						

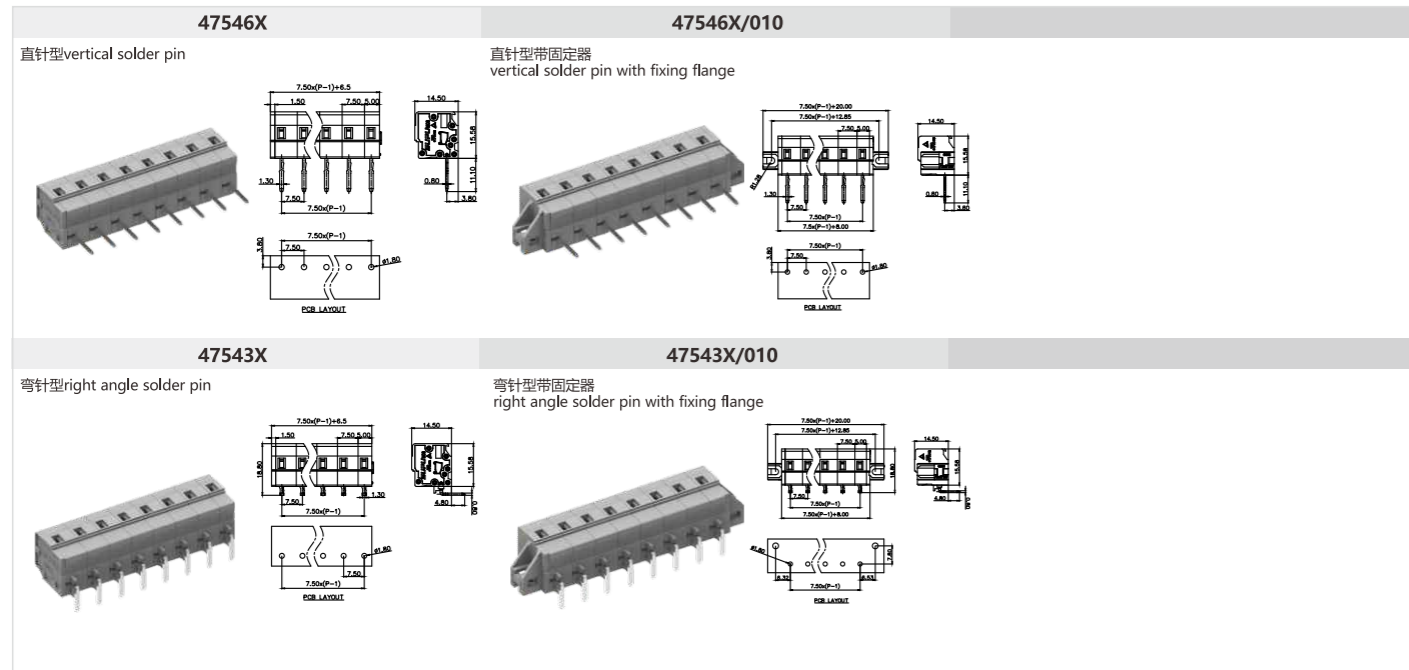

7.5mm间距孔型连接器(防错) 7.5mm Female connectors(protected against mismatching)

产品信息Product Information				锁线螺钉 Locking crew		订货号/通道数 Order No./Poles No.		附件Accessory	
IEC/UL数据 IEC/UL Data	IEC	UL		-	4756XX	2-24	45097X		
额定电流 Rated current	[A]	16	15	扭矩 Torque	[N·m]	-	4756XX/010	2-24	4755XX
额定电压 Rated voltage	[V]	500	300	固定螺钉 Fixed screw	-	4756XX/030	2-24	450021	
硬导线截面积 Solid	[mm ²][AWG]	0.2-2.5	28-14	扭矩 Torque	[N·m]	-	4756XX/050	2-24	450023
柔性导线截面积 Flexible	[mm ²][AWG]	0.2-2.5	28-14	剥线长度 Strip length	[mm]	8-9			450014
额定冲击电压 Rated impulse voltage	[KV]	6.0	-						

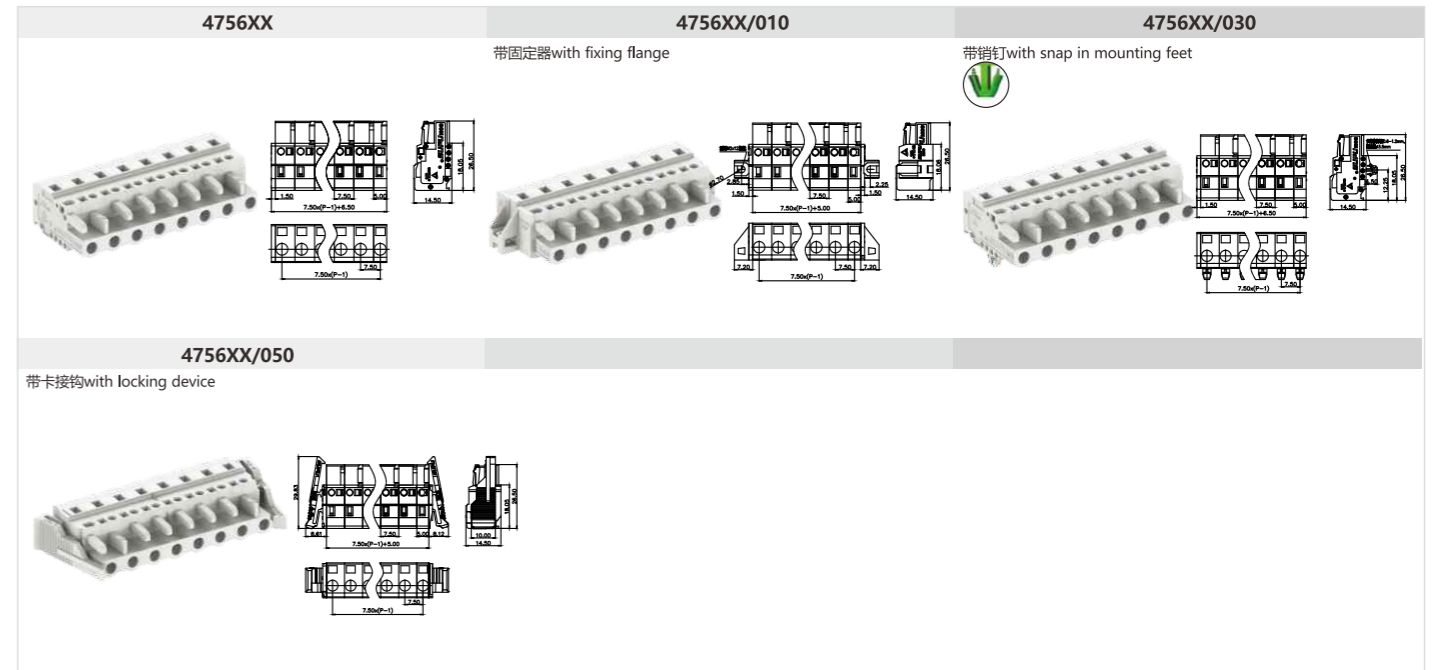

7.5mm间距焊针插座(防错) 7.5mm Solder pin(protected against mismatching)

产品信息Product Information				锁线螺钉 Locking crew		订货号/通道数 Order No./Poles No.		订货号/通道数 Order No./Poles No.	
IEC/UL数据 IEC/UL Data	IEC	UL		-	4757XX	2-24	4757XX-04D	2-24	
额定电流 Rated current	[A]	12	15	扭矩 Torque	[N-m]	-	4757XX-00D	2-24	4757XX-06D
额定电压 Rated voltage	[V]	500	300	固定螺钉 Fixed screw	-	4757XX-02D	2-24	4758XX-06D	2-24
硬导线截面积 Solid	[mm ²][AWG]	-	-	扭矩 Torque	[N-m]	-	4757XX-03D	2-24	
柔性导线截面积 Flexible	[mm ²][AWG]	-	-	剥线长度 Strip length	[mm]	-			
额定冲击电压 Rated impulse voltage	[KV]	6.0	-						

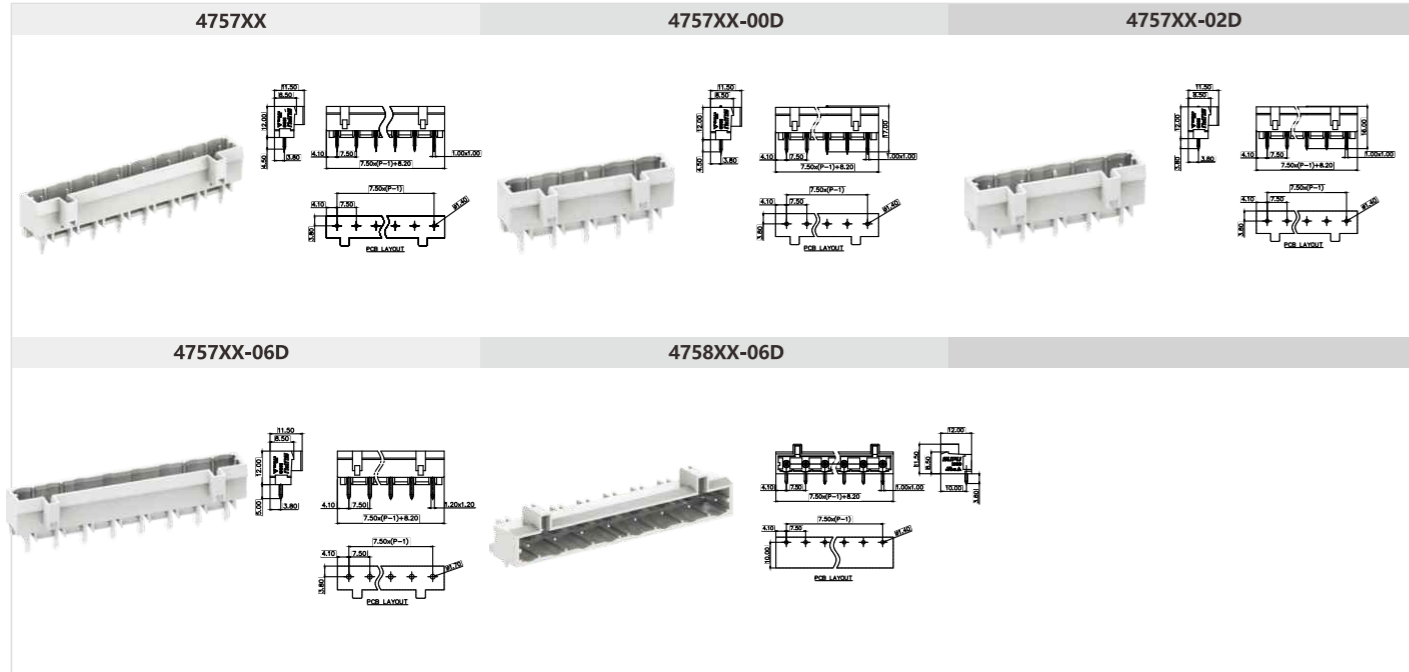

7.5mm间距焊针插座(防错) 7.5mm Solder pin(protected against mismatching)

附件Accessory	
475015	

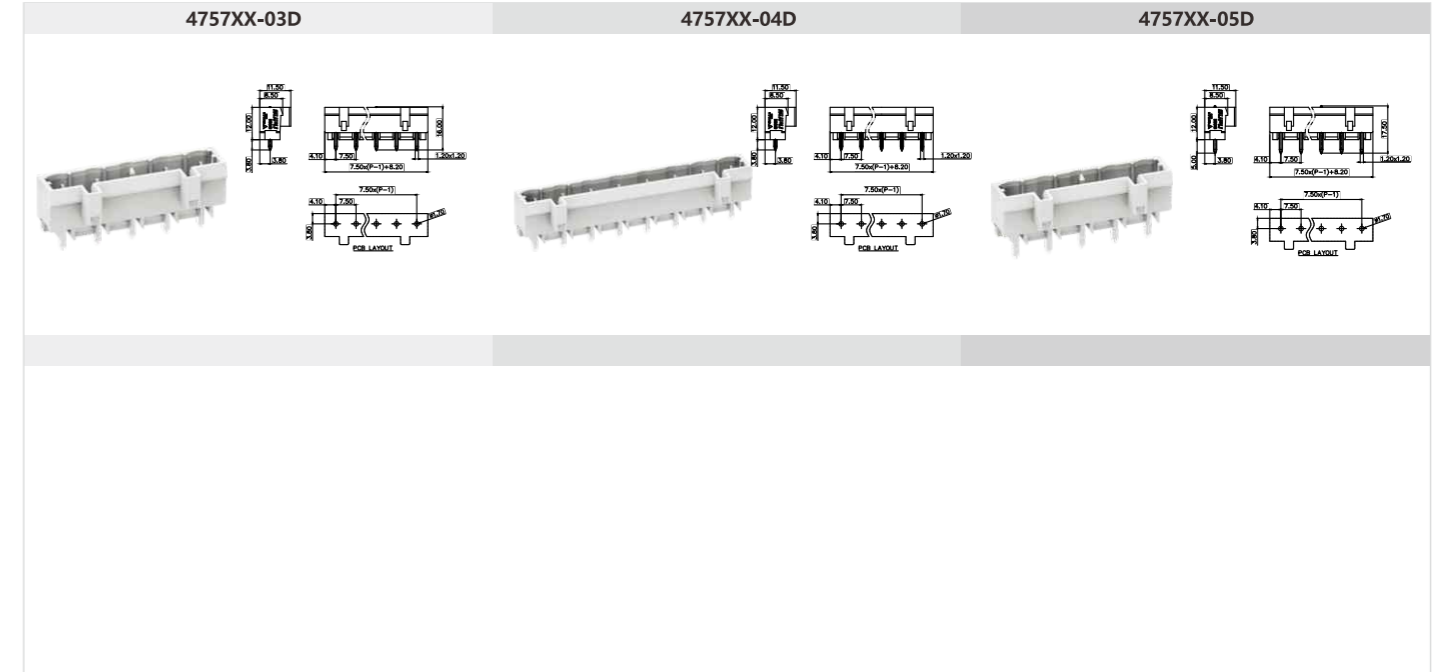

7.5mm间距孔型连接器(防错) 7.5mm Male connector with spring-cage clamp(protected against mismatching)

产品信息Product Information				锁线螺钉 Locking crew		订货号/通道数 Order No./Poles No.		附件Accessory	
IEC/UL数据 IEC/UL Data	IEC	UL		-	4759XX	2-24	45097X		
额定电流 Rated current	[A]	16	15	扭矩 Torque	[N-m]	-	4759XX/010	2-24	4755XX
额定电压 Rated voltage	[V]	500	300	固定螺钉 Fixed screw	-	4759XX/030	2-24	450021	
硬导线截面积 Solid	[mm ²][AWG]	0.2-2.5	28-14	扭矩 Torque	[N-m]	-	4759XX/060	2-24	450023
柔性导线截面积 Flexible	[mm ²][AWG]	0.2-2.5	28-14	剥线长度 Strip length	[mm]	8-9			450014
额定冲击电压 Rated impulse voltage	[KV]	6.0	-						

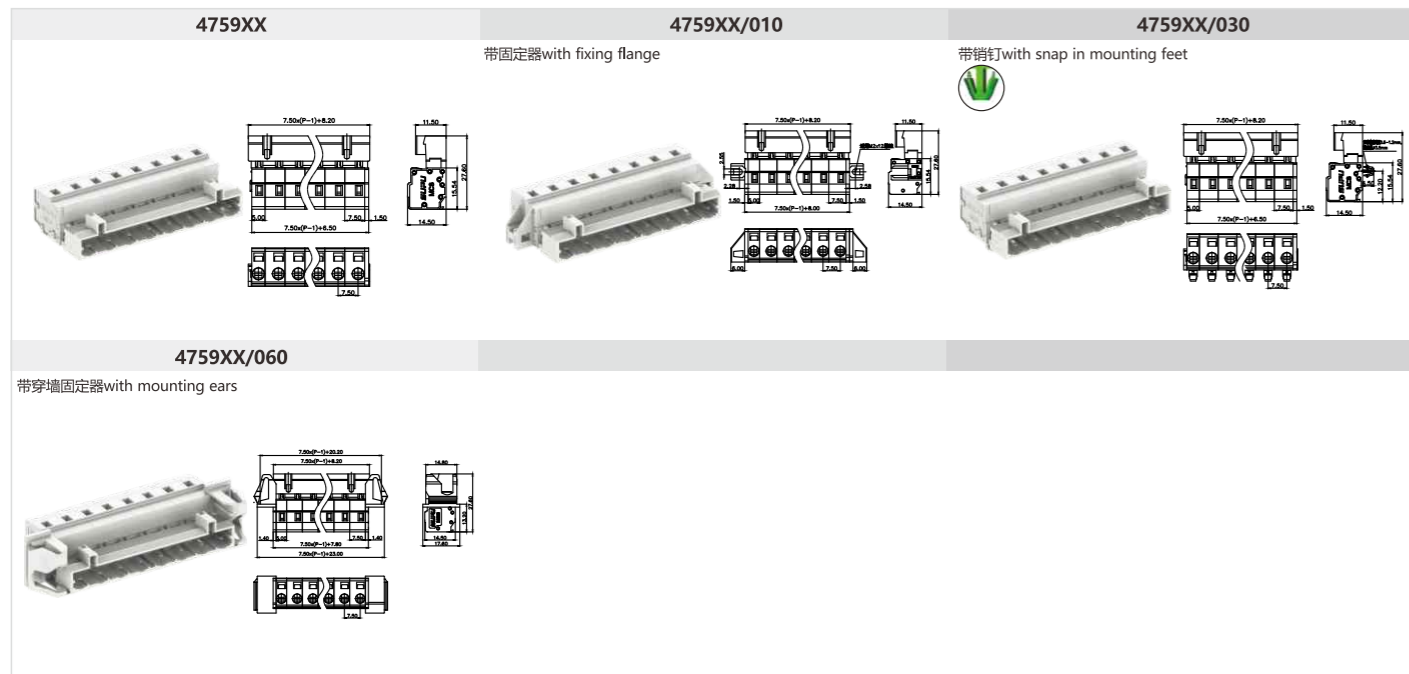

7.5mm间距孔型插头带焊针(防错) 7.5mm Female connector with spring-cage clamp with solder pin(protected against mismatching)

产品信息Product Information				锁线螺钉 Locking crew		订货号/通道数 Order No./Poles No.		附件Accessory	
IEC/UL数据 IEC/UL Data	IEC	UL		-	47575X	2-24			
额定电流 Rated current	[A]	16	15	扭矩 Torque	[N-m]	-	47585X	2-24	
额定电压 Rated voltage	[V]	500	300	固定螺钉 Fixed screw	-				
硬导线截面积 Solid	[mm ²][AWG]	-	-	扭矩 Torque	[N-m]	-			
柔性导线截面积 Flexible	[mm ²][AWG]	-	-	剥线长度 Strip length	[mm]	-			
额定冲击电压 Rated impulse voltage	[KV]	6.0	-						

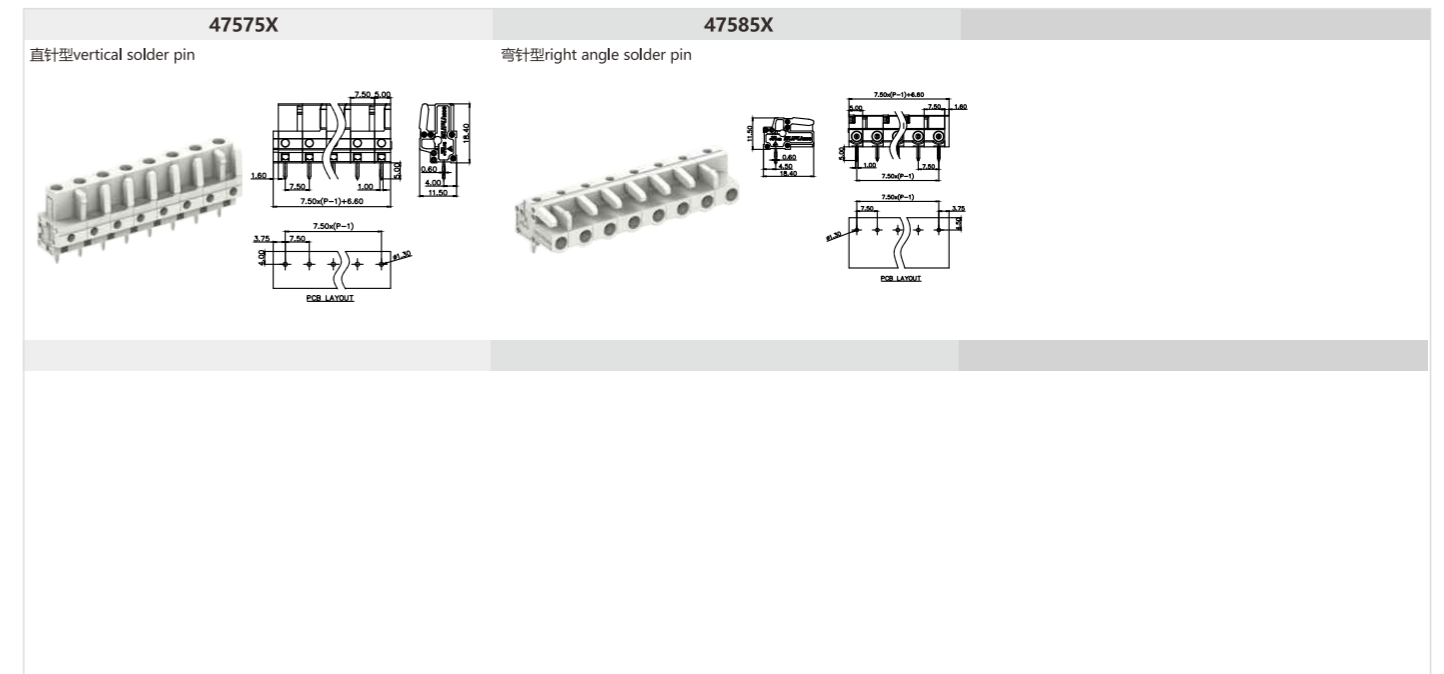

7.62mm间距孔型连接器 7.62mm Female connectors

产品信息Product Information				产品信息Product Information				订货号/通道数 Order No./Poles No.		附件Accessory	
IEC/UL数据 IEC/UL Data	IEC	UL		锁线螺钉 Locking crew	-	4781XX	2-24	45897X			
额定电流 Rated current	[A]	16	15	扭矩 Torque	[N·m]	4781XX/010	2-24	450021			
额定电压 Rated voltage	[V]	500	300	固定螺钉 Fixed screw	-	4781XX/030	2-24	450023			
硬导线截面积 Solid	[mm ²][AWG]	0.2-2.5	28-14	扭矩 Torque	[N·m]	4781XX/050	2-24	450014			
柔性导线截面积 Flexible	[mm ²][AWG]	0.2-2.5	28-14	剥线长度 Strip length	[mm]						
额定冲击电压 Rated impulse voltage	[KV]	6.0	-								

4781XX	4781XX/010	4781XX/030
带固定器 with fixing flange	带固定器 with fixing flange	带销钉 with snap in mounting feet
4781XX/050		
带卡接钩 with locking device		

7.62mm间距针型连接器 7.62mm Male connector with spring-cage clamp

产品信息Product Information				产品信息Product Information				订货号/通道数 Order No./Poles No.		附件Accessory	
IEC/UL数据 IEC/UL Data	IEC	UL		锁线螺钉 Locking crew	-	4784XX	2-24	45897X			
额定电流 Rated current	[A]	16	15	扭矩 Torque	[N·m]	4784XX/010	2-24	450021			
额定电压 Rated voltage	[V]	500	300	固定螺钉 Fixed screw	-	4784XX/030	2-24	450023			
硬导线截面积 Solid	[mm ²][AWG]	0.2-2.5	28-14	扭矩 Torque	[N·m]	4784XX/060	2-24	450014			
柔性导线截面积 Flexible	[mm ²][AWG]	0.2-2.5	28-14	剥线长度 Strip length	[mm]						
额定冲击电压 Rated impulse voltage	[KV]	6.0	-								

4784XX	4784XX/010	4784XX/030
带固定器 with fixing flange	带固定器 with fixing flange	带销钉 with snap in mounting feet
4784XX/060		
带穿墙固定器 with mounting ears		

7.62mm间距焊针插座 7.62mm Solder pin

产品信息Product Information				产品信息Product Information				订货号/通道数 Order No./Poles No.		附件Accessory	
IEC/UL数据 IEC/UL Data	IEC	UL		锁线螺钉 Locking crew	-	4782XX	2-24	475015			
额定电流 Rated current	[A]	16	15	扭矩 Torque	[N·m]	4782XX-04D	2-24				
额定电压 Rated voltage	[V]	500	300	固定螺钉 Fixed screw	-	4782XX-06D	2-24				
硬导线截面积 Solid	[mm ²][AWG]	-	28-14	扭矩 Torque	[N·m]	4783XX	2-24				
柔性导线截面积 Flexible	[mm ²][AWG]	-	28-14	剥线长度 Strip length	[mm]	4783XX-04D	2-24				
额定冲击电压 Rated impulse voltage	[KV]	6.0	-								

4782XX	4782XX-04D	4782XX-06D
4783XX	4783XX-04D	

7.62mm间距穿墙式连接器 7.62mm Through-wall connector

产品信息Product Information				产品信息Product Information				订货号/通道数 Order No./Poles No.		附件Accessory	
IEC/UL数据 IEC/UL Data	IEC	UL		锁线螺钉 Locking crew	-	47846X	2-24	45897X			
额定电流 Rated current	[A]	16	15	扭矩 Torque	[N·m]	47846X/010	2-24	450021			
额定电压 Rated voltage	[V]	500	300	固定螺钉 Fixed screw	-	47843X	2-24	450023			
硬导线截面积 Solid	[mm ²][AWG]	0.2-2.5	28-14	扭矩 Torque	[N·m]	47843X/010	2-24	450014			
柔性导线截面积 Flexible	[mm ²][AWG]	0.2-2.5	28-14	剥线长度 Strip length	[mm]						
额定冲击电压 Rated impulse voltage	[KV]	6.0	-								

47846X	47846X/010
直针型 vertical solder pin	直针型带固定器 vertical solder pin with fixing flange
47843X	47843X/010
弯针型 right angle solder pin	弯针型带固定器 right angle solder pin with fixing flange

冷压式连接器 Connectors with male/female ferrule

产品信息Product Information				产品信息Product Information				订货号/通道数 Order No./Poles No.		附件Accessory	
IEC/UL数据 IEC/UL Data	IEC	UL	锁线螺钉 Locking crew	-	BL635VXXF-WT-0000	2-5	B05010001				
额定电流 Rated current [A]	-	-	扭矩 Torque [N·m]	-	BL635VXXF-WT-0000	6-15					
额定电压 Rated voltage [V]	600	-	固定螺钉 Fixed screw	-	BL635VXXM-WT-0000	2-5					
硬导线截面积 Solid [mm ²][AWG]	-	-	扭矩 Torque [N·m]	-	BL635VXXM-WT-0000	6-15					
柔性导线截面积 Flexible [mm ²][AWG]	-	-	剥线长度 Strip length [mm]	-							
额定冲击电压 Rated impulse voltage [KV]	4.0	-									

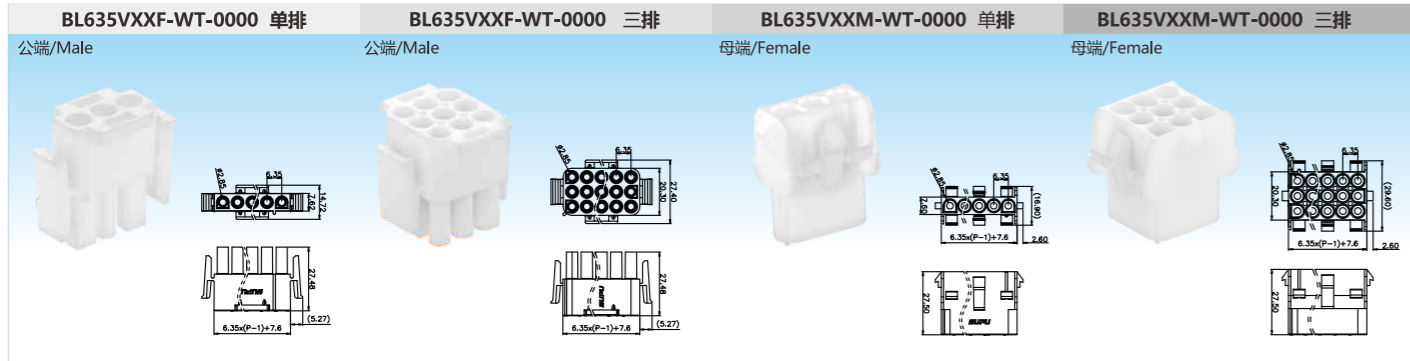

PCB焊板式连接器 Connector PCB type

产品信息Product Information				产品信息Product Information				订货号/通道数 Order No./Poles No.		附件Accessory	
IEC/UL数据 IEC/UL Data	IEC	UL	锁线螺钉 Locking crew	-	BP635VXXM-WT-0000	2-5	B05010002				
额定电流 Rated current [A]	12	-	扭矩 Torque [N·m]	-	BP635VXXM-WT-0000	6-15					
额定电压 Rated voltage [V]	600	-	固定螺钉 Fixed screw	-	BP635VXXF-WT-0000	2-5					
硬导线截面积 Solid [mm ²][AWG]	-	-	扭矩 Torque [N·m]	-	BP635VXXF-WT-0000	6-15					
柔性导线截面积 Flexible [mm ²][AWG]	-	-	剥线长度 Strip length [mm]	-							
额定冲击电压 Rated impulse voltage [KV]	4.0	-									

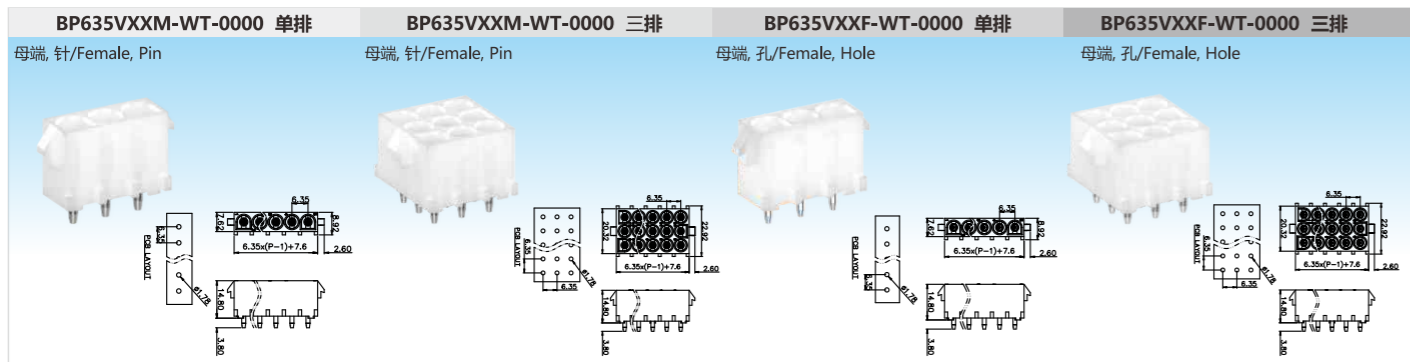

冷压式金属件 Cold pressed metal parts

产品信息Product Information				产品信息Product Information			
IEC/UL数据 IEC/UL Data	IEC	UL	IEC/UL数据 IEC/UL Data	IEC	UL		
额定电流 Rated current [A]	12	-	额定电流 Rated current [A]	12	-		
额定电压 Rated voltage [V]	600	-	额定电压 Rated voltage [V]	600	-		
硬导线截面积 Solid [mm ²][AWG]	-	-	硬导线截面积 Solid [mm ²][AWG]	-	-		
柔性导线截面积 Flexible [mm ²][AWG]	0.5-2.0	-	柔性导线截面积 Flexible [mm ²][AWG]	0.2-0.8	-		
额定冲击电压 Rated impulse voltage [KV]	4.0	-	额定冲击电压 Rated impulse voltage [KV]	4.0	-		

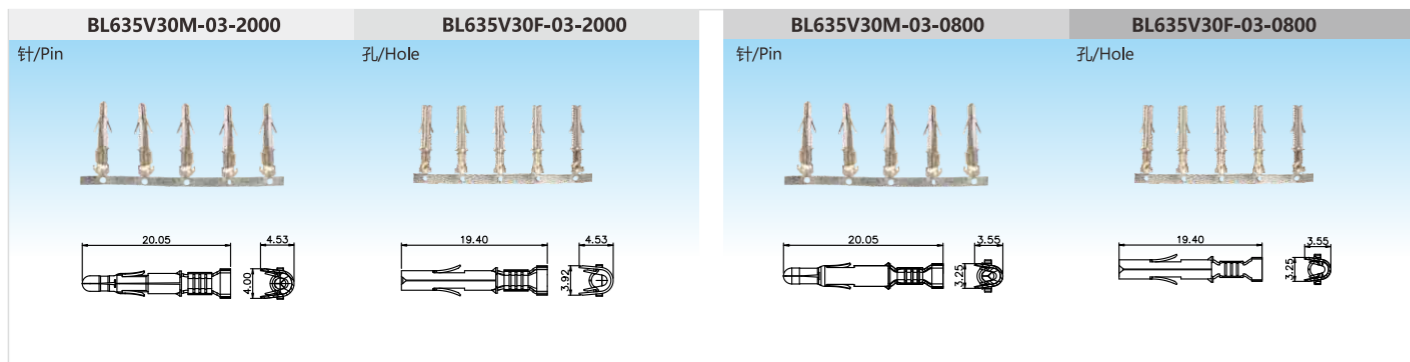

冷压式安全回路防错连接器 Connectors with circuit protected against mismatching

产品信息Product Information				订货号/通道数 Order No./Poles No.			
IEC/UL数据 IEC/UL Data	IEC	UL	BL635V34F-WT-0000-XX	12	BL635V34M-WT-0000-XX	12	
额定电流 Rated current [A]	-	-	公端/Male		母端/Female		
额定电压 Rated voltage [V]	600	-					
硬导线截面积 Solid [mm ²][AWG]	-	-					
柔性导线截面积 Flexible [mm ²][AWG]	-	-					
额定冲击电压 Rated impulse voltage [KV]	4.0	-					
锁线螺钉 Locking crew	-	-					
扭矩 Torque [N·m]	-	-					
固定螺钉 Fixed screw	-	-					
扭矩 Torque [N·m]	-	-					
剥线长度 Strip length [mm]	-	-					
附件Accessory							
B05010001							

B系列冷压式安全回路防错孔型连接器 (含11种防错)
11 Poles products (protected against mismatching)structure diagram

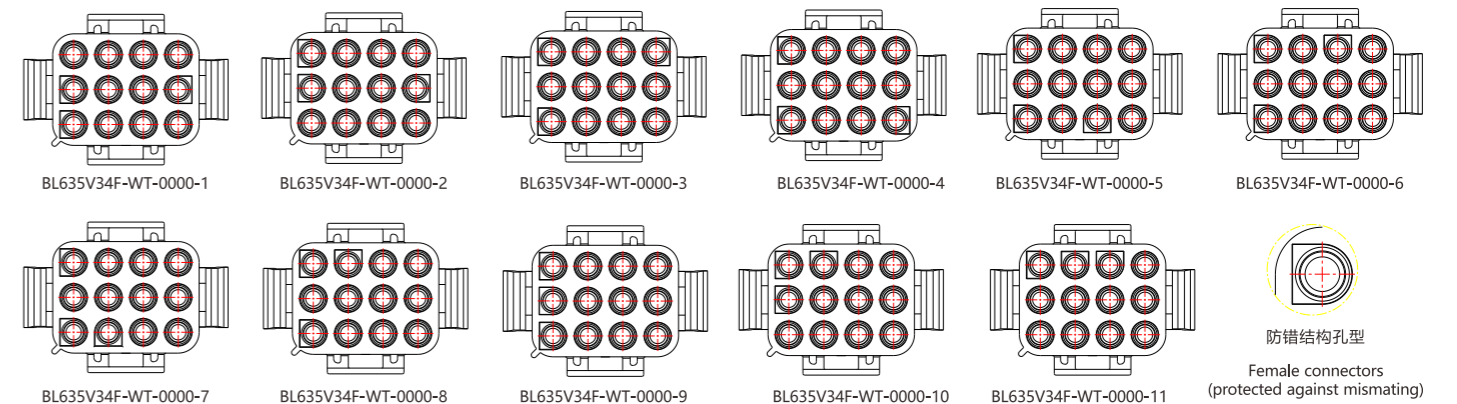

B系列冷压式安全回路防错针型连接器 (含11种防错)
11 Poles products (protected against mismatching)structure diagram

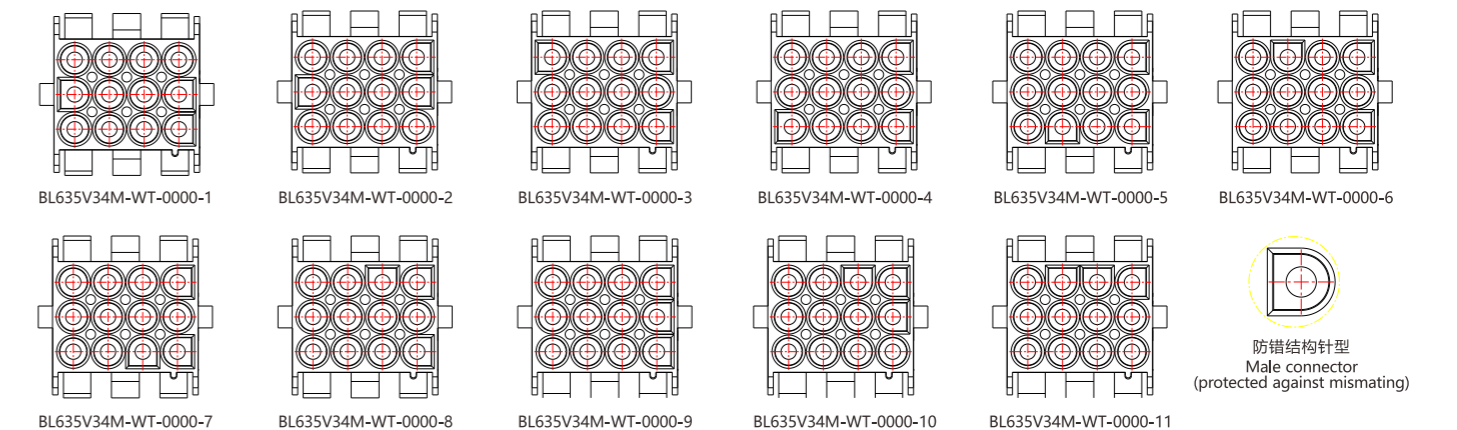

SUP系列变压器专用端子 SUP series transformer terminal block

产品信息 Product Information		IEC	UL
额定电流 Rated current	[A]	32	20
额定电压 Rated voltage	[V]	600	600
硬导线截面积 Solid	[mm²][AWG]	0.5-4.0	24-12
柔性导线截面积 Flexible	[mm²][AWG]	0.5-4.0	24-12
额定冲击电压 Rated impulse voltage	[KV]	3.0	-
锁线螺钉 Locking crew		M4	
扭矩 Torque	[N-m]	1.2	
固定螺钉 Fixed screw		-	
扭矩 Torque	[N-m]	-	
剥线长度 Strip length	[mm]	8-9	

订货号/颜色/通道数 Order No. /Colour/Poles No.
620111 ○ 灰色 Gray 1
620112 ● 橙色 Orange 1

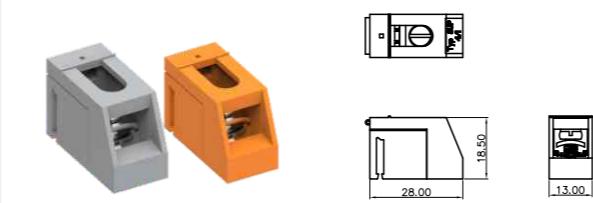

产品信息 Product Information		IEC	UL
额定电流 Rated current	[A]	24	20
额定电压 Rated voltage	[V]	600	600
硬导线截面积 Solid	[mm²][AWG]	0.5-2.5	24-14
柔性导线截面积 Flexible	[mm²][AWG]	0.5-2.5	24-14
额定冲击电压 Rated impulse voltage	[KV]	3.0	-
锁线螺钉 Locking crew		M3.5	
扭矩 Torque	[N-m]	0.8	
固定螺钉 Fixed screw		-	
扭矩 Torque	[N-m]	-	
剥线长度 Strip length	[mm]	8-9	

订货号/颜色/通道数 Order No. /Colour/Poles No.
620121 ○ 灰色 Gray 2
620122 ● 橙色 Orange 2

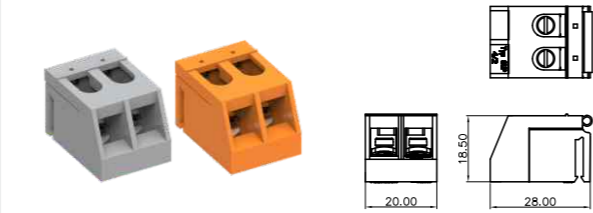

产品信息 Product Information		IEC	UL
额定电流 Rated current	[A]	10	10
额定电压 Rated voltage	[V]	600	600
硬导线截面积 Solid	[mm²][AWG]	0.5-2.5	24-12
柔性导线截面积 Flexible	[mm²][AWG]	0.5-2.5	24-12
额定冲击电压 Rated impulse voltage	[KV]	3.0	-
锁线螺钉 Locking crew		M3.5	
扭矩 Torque	[N-m]	0.8	
固定螺钉 Fixed screw		-	
扭矩 Torque	[N-m]	-	
剥线长度 Strip length	[mm]	8-9	

订货号/颜色/通道数 Order No. /Colour/Poles No.
620151 ○ 灰色 Gray 1
620152 ● 橙色 Orange 1

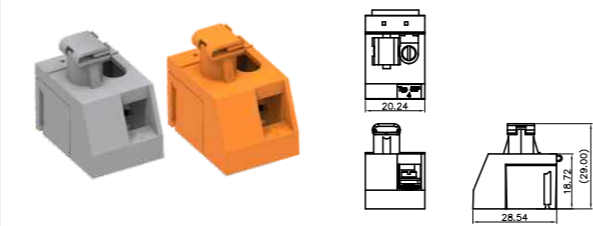

产品信息 Product Information		IEC	UL
额定电流 Rated current	[A]	32	20
额定电压 Rated voltage	[V]	600	600
硬导线截面积 Solid	[mm²][AWG]	0.5-4.0	24-12
柔性导线截面积 Flexible	[mm²][AWG]	0.5-4.0	24-12
额定冲击电压 Rated impulse voltage	[KV]	3.0	-
锁线螺钉 Locking crew		M4	
扭矩 Torque	[N-m]	1.2	
固定螺钉 Fixed screw		-	
扭矩 Torque	[N-m]	-	
剥线长度 Strip length	[mm]	8-9	

订货号/颜色/通道数 Order No. /Colour/Poles No.
620171 ○ 灰色 Gray 1
620172 ● 橙色 Orange 1

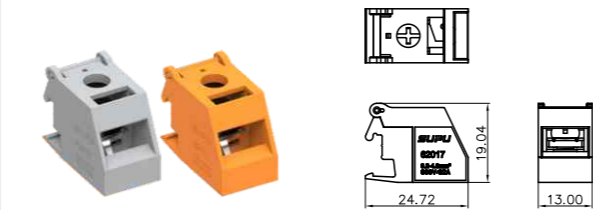

产品信息 Product Information		IEC	UL
额定电流 Rated current	[A]	32	20
额定电压 Rated voltage	[V]	600	600
硬导线截面积 Solid	[mm²][AWG]	0.5-2.5	24-14
柔性导线截面积 Flexible	[mm²][AWG]	0.5-2.5	24-14
额定冲击电压 Rated impulse voltage	[KV]	3.0	-
锁线螺钉 Locking crew		M3	
扭矩 Torque	[N-m]	0.5	
固定螺钉 Fixed screw		-	
扭矩 Torque	[N-m]	-	
剥线长度 Strip length	[mm]	8-9	

订货号/颜色/通道数 Order No. /Colour/Poles No.
620181 ○ 灰色 Gray 2
620182 ● 橙色 Orange 2

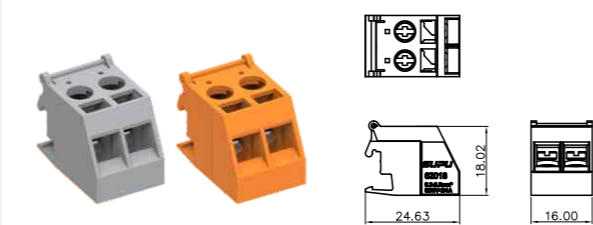

产品信息 Product Information		IEC	UL
额定电流 Rated current	[A]	10	10
额定电压 Rated voltage	[V]	600	600
硬导线截面积 Solid	[mm²][AWG]	0.5-2.5	24-12
柔性导线截面积 Flexible	[mm²][AWG]	0.5-2.5	24-12
额定冲击电压 Rated impulse voltage	[KV]	3.0	-
锁线螺钉 Locking crew		M3.5	
扭矩 Torque	[N-m]	0.8	
固定螺钉 Fixed screw		-	
扭矩 Torque	[N-m]	-	
剥线长度 Strip length	[mm]	8-9	

订货号/颜色/通道数 Order No. /Colour/Poles No.
620161 ○ 灰色 Gray 1
620162 ● 橙色 Orange 1

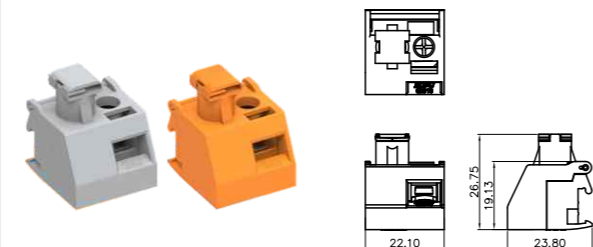

TRS系列变压器专用端子 TRS series transformer terminal block

产品信息 Product Information		IEC	UL
额定电流 Rated current	[A]	32	20
额定电压 Rated voltage	[V]	600	300
硬导线截面积 Solid	[mm²][AWG]	0.2-4.0	24-12
柔性导线截面积 Flexible	[mm²][AWG]	0.2-4.0	24-12
额定冲击电压 Rated impulse voltage	[KV]	3.0	-
锁线螺钉 Locking crew		M3	
扭矩 Torque	[N-m]	0.5	
固定螺钉 Fixed screw		-	
扭矩 Torque	[N-m]	-	
剥线长度 Strip length	[mm]	8-9	

订货号/颜色/通道数 Order No. /Colour/Poles No.
620211 ○ 灰色 Gray 1
620212 ● 橙色 Orange 1
620213 ● 绿色 Green 1
620217 ● 黄绿色 Yellow green 1

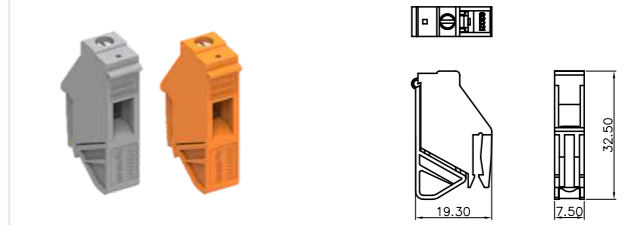

产品信息 Product Information		IEC	UL
额定电流 Rated current	[A]	32	20
额定电压 Rated voltage	[V]	600	300
硬导线截面积 Solid	[mm²][AWG]	0.2-4.0	24-12
柔性导线截面积 Flexible	[mm²][AWG]	0.2-4.0	24-12
额定冲击电压 Rated impulse voltage	[KV]	3.0	-
锁线螺钉 Locking crew		M3	
扭矩 Torque	[N-m]	0.5	
固定螺钉 Fixed screw		-	
扭矩 Torque	[N-m]	-	
剥线长度 Strip length	[mm]	8-9	

订货号/颜色/通道数 Order No. /Colour/Poles No.
620221 ○ 灰色 Gray 2
620222 ● 橙色 Orange 2
620223 ● 绿色 Green 2
620227 ● 黄绿色 Yellow green 2

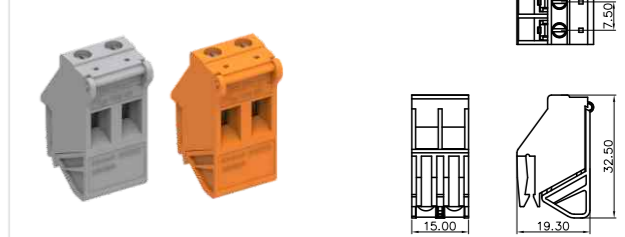

产品信息 Product Information		IEC	UL
额定电流 Rated current	[A]	32	20
额定电压 Rated voltage	[V]	600	300
硬导线截面积 Solid	[mm²][AWG]	0.2-4.0	24-12
柔性导线截面积 Flexible	[mm²][AWG]	0.2-4.0	24-12
额定冲击电压 Rated impulse voltage	[KV]	3.0	-
锁线螺钉 Locking crew		M3	
扭矩 Torque	[N-m]	0.5	
固定螺钉 Fixed screw		-	
扭矩 Torque	[N-m]	-	
剥线长度 Strip length	[mm]	8-9	

订货号/颜色/通道数 Order No. /Colour/Poles No.
620231 ○ 灰色 Gray 3
620232 ● 橙色 Orange 3
620233 ● 绿色 Green 3
620237 ● 黄绿色 Yellow green 3

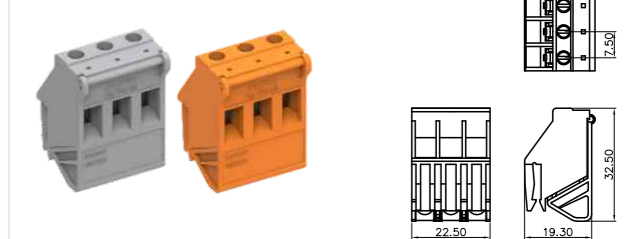

产品信息 Product Information		IEC	UL
额定电流 Rated current	[A]	10	10
额定电压 Rated voltage	[V]	600	300
硬导线截面积 Solid	[mm²][AWG]	0.2-4.0	24-12
柔性导线截面积 Flexible	[mm²][AWG]	0.2-4.0	24-12
额定冲击电压 Rated impulse voltage	[KV]	3.0	-
锁线螺钉 Locking crew		M3	
扭矩 Torque	[N-m]	0.5	
固定螺钉 Fixed screw		-	
扭矩 Torque	[N-m]	-	
剥线长度 Strip length	[mm]	8-9	

订货号/颜色/通道数 Order No. /Colour/Poles No.
620251 ○ 灰色 Gray 1
620252 ● 橙色 Orange 1
620253 ● 绿色 Green 1
620257 ● 黄绿色 Yellow green 1

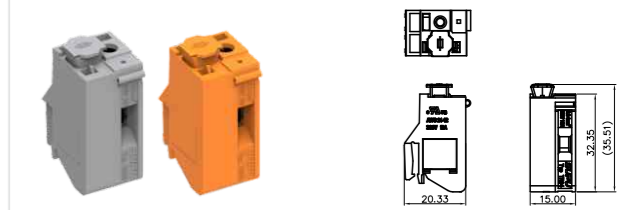

产品信息 Product Information		IEC	UL
额定电流 Rated current	[A]	57	65
额定电压 Rated voltage	[V]	750	300
硬导线截面积 Solid	[mm²][AWG]	4.0-10.0	12-6
柔性导线截面积 Flexible	[mm²][AWG]	4.0-10.0	12-6
额定冲击电压 Rated impulse voltage	[KV]	3.0	-
锁线螺钉 Locking crew		M4	
扭矩 Torque	[N-m]	1.2	
固定螺钉 Fixed screw		-	
扭矩 Torque	[N-m]	-	
剥线长度 Strip length	[mm]	8-9	

订货号/颜色/通道数 Order No. /Colour/Poles No.
620521 ○ 灰色 Gray 2
620522 ● 橙色 Orange 2

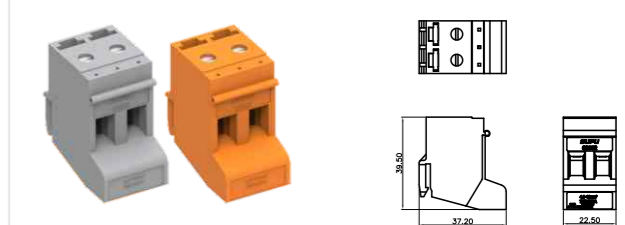

产品信息 Product Information		IEC	UL
额定电流 Rated current	[A]	57	65
额定电压 Rated voltage	[V]	750	300
硬导线截面积 Solid	[mm²][AWG]	4.0-10.0	12-6
柔性导线截面积 Flexible	[mm²][AWG]	4.0-10.0	12-6
额定冲击电压 Rated impulse voltage	[KV]	3.0	-
锁线螺钉 Locking crew		M4	
扭矩 Torque	[N-m]	1.2	
固定螺钉 Fixed screw		-	
扭矩 Torque	[N-m]	-	
剥线长度 Strip length	[mm]	8-9	

订货号/颜色/通道数 Order No. /Colour/Poles No.
620531 ○ 灰色 Gray 3
620532 ● 橙色 Orange 3

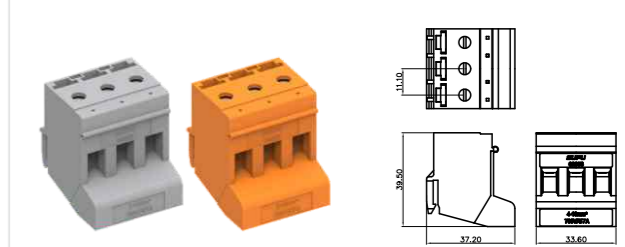

TRS系列变压器专用端子 TRS series transformer terminal block

产品信息 Product Information		IEC	UL
IEC/UL数据 IEC/UL Data			
额定电流 Rated current [A]	10	10	
额定电压 Rated voltage [V]	600	600	
硬导线截面积 Solid [mm ²][AWG]	0.2-4.0	24-12	
柔性导线截面积 Flexible [mm ²][AWG]	0.2-4.0	24-12	
额定冲击电压 Rated impulse voltage [KV]	3.0	-	
锁线螺钉 Locking crew		M3	
扭矩 Torque [N-m]	0.6-0.8		
固定螺钉 Fixed screw	-		
扭矩 Torque [N-m]	-		
剥线长度 Strip length [mm]	8-9		

订货号/颜色/通道数 Order No. /Colour/Poles No.		
620261	灰色 Gray	1
620262	橙色 Orange	1

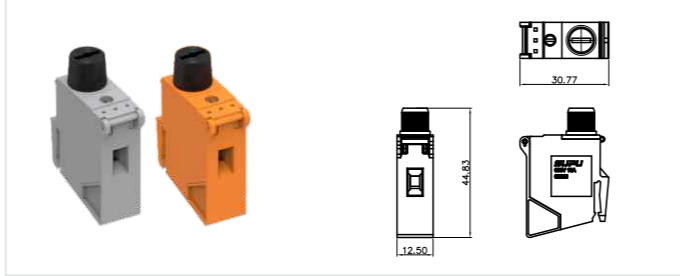

TRST系列变压器专用端子 TRST series transformer terminal block

产品信息 Product Information		IEC	UL
IEC/UL数据 IEC/UL Data			
额定电流 Rated current [A]	32	20	
额定电压 Rated voltage [V]	600	300	
硬导线截面积 Solid [mm ²][AWG]	0.5-4.0	20-12	
柔性导线截面积 Flexible [mm ²][AWG]	0.5-4.0	20-12	
额定冲击电压 Rated impulse voltage [KV]	3.0	-	
锁线螺钉 Locking crew		M3.5	
扭矩 Torque [N-m]	0.8		
固定螺钉 Fixed screw	-		
扭矩 Torque [N-m]	-		
剥线长度 Strip length [mm]	8-9		

订货号/颜色/通道数 Order No. /Colour/Poles No.		
620411	灰色 Gray	1
620412	橙色 Orange	1

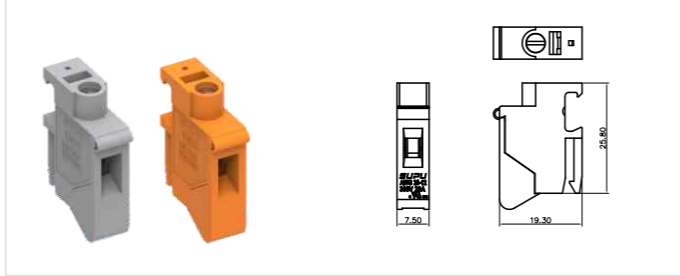

产品信息 Product Information		IEC	UL
IEC/UL数据 IEC/UL Data			
额定电流 Rated current [A]	32	20	
额定电压 Rated voltage [V]	600	300	
硬导线截面积 Solid [mm ²][AWG]	0.5-4.0	20-12	
柔性导线截面积 Flexible [mm ²][AWG]	0.5-4.0	20-12	
额定冲击电压 Rated impulse voltage [KV]	3.0	-	
锁线螺钉 Locking crew		M3.5	
扭矩 Torque [N-m]	0.8		
固定螺钉 Fixed screw	-		
扭矩 Torque [N-m]	-		
剥线长度 Strip length [mm]	8-9		

订货号/颜色/通道数 Order No. /Colour/Poles No.		
620421	灰色 Gray	2
620422	橙色 Orange	2

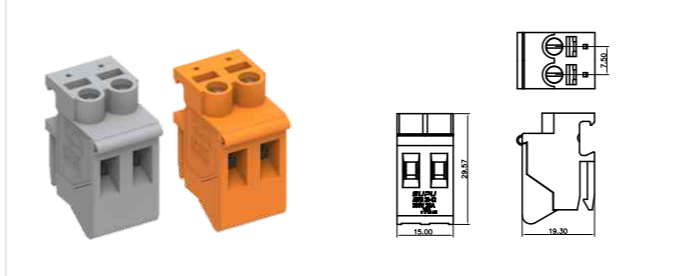

产品信息 Product Information		IEC	UL
IEC/UL数据 IEC/UL Data			
额定电流 Rated current [A]	32	20	
额定电压 Rated voltage [V]	600	300	
硬导线截面积 Solid [mm ²][AWG]	0.5-4.0	20-12	
柔性导线截面积 Flexible [mm ²][AWG]	0.5-4.0	20-12	
额定冲击电压 Rated impulse voltage [KV]	3.0	-	
锁线螺钉 Locking crew		M3.5	
扭矩 Torque [N-m]	0.8		
固定螺钉 Fixed screw	-		
扭矩 Torque [N-m]	-		
剥线长度 Strip length [mm]	8-9		

订货号/颜色/通道数 Order No. /Colour/Poles No.		
620611	灰色 Gray	1
620612	橙色 Orange	1

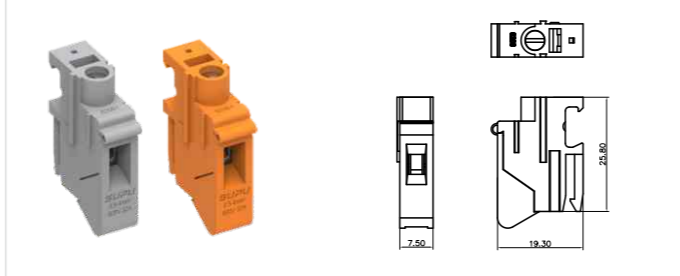

导线截面积和直径之间对应关系表 The corresponding relation between mm² and AWG

导线截面积 Wire area mm ²	最大导体的理论直径 Theoretical diameter						
	公制 Metric			AWG/kcmil			
	硬线 Solid		软线 Flexible wire mm	硬线 Solid		软线 Flexible wire mm	
	实心线 Solid wire mm	多股线 Stranded wire mm		规格 specification	实心线 Solid wire mm		多股线 Stranded wire mm
0.2	0.51	0.53	0.61	24	0.54	0.61	0.64
0.34	0.63	0.66	0.8	22	0.68	0.71	0.80
0.5	0.9	1.1	1.1	20	0.85	0.97	1.02
0.75	1	1.2	1.3	18	1.07	1.23	1.28
1.0	1.2	1.4	1.5	-	-	-	-
1.5	1.5	1.7	1.8	16	1.35	1.55	1.6
2.5	1.9	2.2	2.3	14	1.71	1.95	2.08
4	2.4	2.7	2.9	12	2.15	2.45	2.7
6	2.9	3.3	3.9	10	2.72	3.09	3.36
10	3.7	4.2	5.1	8	3.43	3.89	4.32
16	4.6	5.3	6.3	6	4.32	4.91	5.73
25	-	6.6	7.8	4	5.45	6.18	7.26
35	-	7.9	9.2	2	6.87	7.78	9.02

导线类型 Wire Type

- s: 实心线/Solid wire
- f: 柔性线/Flexible wire
- s+f-st: 实心线和柔性线/Solid wire and flexible wire
- sol: 实心线/Solid wire
- f-st: 柔性线/Flexible wire

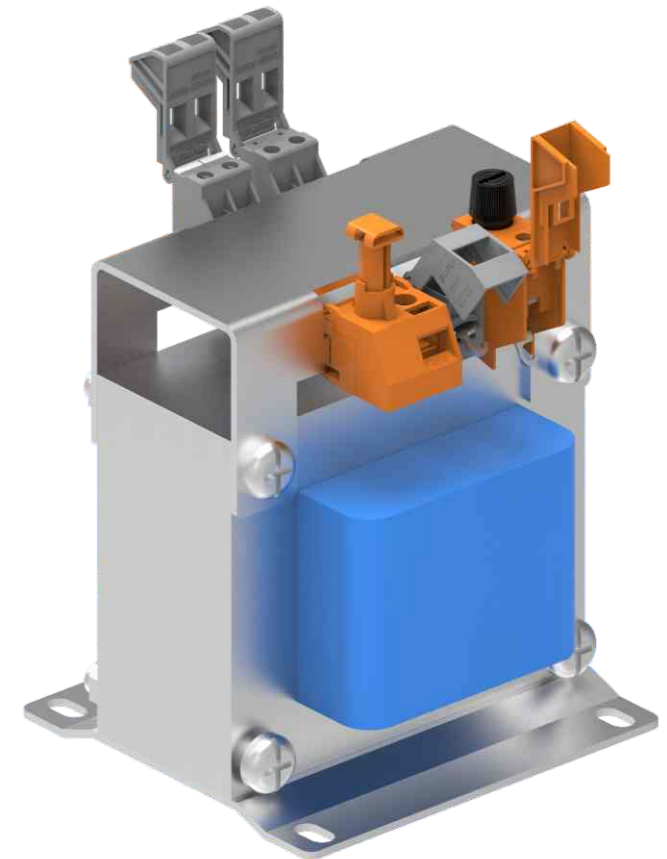

SCW4系列穿墙端子 SCWH4 series panel feed-through terminal blockSeries PCB terminal block

产品信息Product Information		订货号/通道数 Order No./Poles No.	
IEC/UL数据 IEC/UL Data	IEC UL	SCWH4	2
额定电流 Rated current	[A] 41 30	SCWH4S	2
额定电压 Rated voltage	[V] 500 300		
硬导线截面积 Solid [mm ²][AWG]	0.2-6.0 24-10		
柔性导线截面积 Flexible [mm ²][AWG]	0.2-4.0 24-10		
额定冲击电压 Rated impulse voltage	[KV] 6.0 -		
锁线螺钉 Locking crew	M3		
扭矩 Torque	[N·m] 0.5		
固定螺钉 Fixed screw	-		
扭矩 Torque	[N·m] -		
剥线长度 Strip length	[mm] 8-10		
附件Accessory			
SCWH4-F	306801		
TJB8.2-XX			

SCW10系列穿墙端子 SCWH10 series panel feed-through terminal blockSeries PCB terminal block

产品信息Product Information		订货号/通道数 Order No./Poles No.	
IEC/UL数据 IEC/UL Data	IEC UL	SCWH10	2
额定电流 Rated current	[A] 76 65	SCWH10S	2
额定电压 Rated voltage	[V] 500 300		
硬导线截面积 Solid [mm ²][AWG]	0.5-16 20-6		
柔性导线截面积 Flexible [mm ²][AWG]	0.5-16 20-6		
额定冲击电压 Rated impulse voltage	[KV] 6.0 -		
锁线螺钉 Locking crew	M4		
扭矩 Torque	[N·m] 1.2		
固定螺钉 Fixed screw	-		
扭矩 Torque	[N·m] -		
剥线长度 Strip length	[mm] 10-12		
附件Accessory			
SCWH10-F	TMB10.2-10		
TJB10.2-XX			

SCW16系列穿墙端子 SCWH16 series panel feed-through terminal blockSeries PCB terminal block

产品信息Product Information		订货号/通道数 Order No./Poles No.	
IEC/UL数据 IEC/UL Data	IEC UL	SCWH16	2
额定电流 Rated current	[A] 76 30	SCWH16S	2
额定电压 Rated voltage	[V] 800 300		
硬导线截面积 Solid [mm ²][AWG]	6-25 24-10		
柔性导线截面积 Flexible [mm ²][AWG]	6-16 24-10		
额定冲击电压 Rated impulse voltage	[KV] 8.0 -		
锁线螺钉 Locking crew	M5		
扭矩 Torque	[N·m] 0.5		
固定螺钉 Fixed screw	-		
扭矩 Torque	[N·m] -		
剥线长度 Strip length	[mm] 16		
附件Accessory			
SCWH16-F	TMB10.2-10		

SCW25系列穿墙端子 SCWH25 series panel feed-through terminal blockSeries PCB terminal block

产品信息Product Information		订货号/通道数 Order No./Poles No.	
IEC/UL数据 IEC/UL Data	IEC UL	SCWH25	2
额定电流 Rated current	[A] 101 112.5	SCWH25S	2
额定电压 Rated voltage	[V] 800 600		
硬导线截面积 Solid [mm ²][AWG]	6-35 10-2		
柔性导线截面积 Flexible [mm ²][AWG]	10-25 10-2		
额定冲击电压 Rated impulse voltage	[KV] 8.0 -		
锁线螺钉 Locking crew	M5		
扭矩 Torque	[N·m] 2.5-4.5		
固定螺钉 Fixed screw	-		
扭矩 Torque	[N·m] -		
剥线长度 Strip length	[mm] 18-20		
附件Accessory			
SCWH25-F	TMB10.2-10		

组装端子块 Forming terminal blocks

- 卡紧 Snap-mounting
 - ① 您可以将订货号尾部为S的端子相互插接在一起，或者与订货号尾部不带S的端子插装在一起。
The terminals designated with S can be snapped together with each other (or with terminals without S)

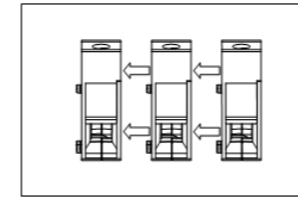

具体开孔尺寸请详见产品规格书
Please refer to the product specification for the specific size of the hole

- 侧端固定片 (法兰板) Flange plates
 - ② 可以在侧面安装侧端固定片通过旋紧侧端固定片上的螺钉而将端子块固定于仪器壳体上。
At the sides, you can snap on flange plates. You can use the flange connection to attach terminal block to the housing panel.

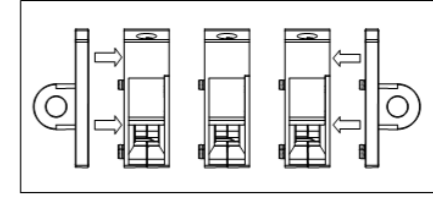











订货号规则/Order number rule

XXX	XXX	X	X	X	XX
外接线方式 Outside wiring method 弹簧 Spring cage/SPW 螺钉 Screw fastener/SCW 螺栓 Screw bolt/BSW	内接线方式 Inside wiring method 与外侧相同 Same as outside/null 扁平快插 Fatplug in/SCM 焊接 Soldering/SL	接线方向 Wiring direction 水平 Horizontal/H 垂直 Vertical/V	接线容量 Wire capacity 4MM ² /4 10MM ² /10 16MM ² /16 25MM ² /25 50MM ² /50 95MM ² /95	是否带柱 With post if Yes/null 不带柱 if no/S	颜色 Colour 灰色 Gray/GY 橙色 Orange/OG 蓝色 Blue/BU 红色 Red/RD 黄色 Yellow/YE 黑色 Black/BK 绿色 Green/CN 白灰色 Light gry/null

举例 example
SCWH4解释为 (外侧接线为螺钉接线, 内侧接线与外侧相同, 接线方向为水平接线, 接线容量为4mm², 带柱子白灰色)
SCWH4 means : Both the outside and inside are screw fastener connection , horizontal wiring, wire capacity is 4mm², with post . white colour .

插拔式端子附件 Pluggable terminal block accessory

护线板Protection plate	订货号Order NO.	间距Pitch	宽度Width	通道数Poles No.	匹配型号Apply ID
	MC-GW5.08-9.9	5.08mm	9.9mm	2-4	MC-RB5.0/5.08系列
	MC-GW5.08-19.9	5.08mm	19.9mm	5-8	MC-RB5.0/5.08系列
	MC-GW5.08-39.9	5.08mm	39.9mm	9-24	MC-RB5.0/5.08系列
护线盒Relief housing	订货号Order NO.	间距Pitch	宽度Width	通道数Poles No.	匹配型号Apply ID
	MC-WG5.0-2	5.0mm	10mm	2	MC-RB5.0/5.08系列
	MC-WG5.0-3	5.0mm	15mm	3	MC-RB5.0/5.08系列
跨接桥Jumper	订货号Order NO.	间距Pitch	宽度Width	通道数Poles No.	匹配型号Apply ID
	MC-JP3.81-X	3.81mm	-	2-6	MC-RA/RE/RF/RJ/RAF3.81系列
	MC-JP5.0-X	5.0mm	-	2-6	MC-RB/RE/RJ5.08系列 MC-RB/RE/RBF5.08系列
防错插片Coding profile	订货号Order NO.	间距Pitch	宽度Width	通道数Poles No.	匹配型号Apply ID
	MC-R-MSTB	-	-	-	MC-RB/RE/RJ5.08系列 MC-RB/RE/RBF5.08系列
	MC-P-MSTB	-	-	-	MC-PA/RE/RJ5.08系列 MC-PC/RB/RE/RBF5.08系列
	MC-R-RH7.62	-	-	-	MC-RHH/PH/PHH/RQ7.62系列 MC-RHH/PH10.16系列
	MC-R-PA2.5	2.5mm	-	-	MC-PA2.5系列
	MC-CQ5.08-XX	5.08m	-	2-24	MC-PB5.08HXXC-K-0001系列
	MC-GW5.08-10.1	5.08m	-	-	MC-RB5.08HXXB-D系列
	MC-JT5.0	5.0m	-	-	MC-ROX5.0/7.5-0002系列
	MC-QX5.0	5.08m	-	-	MC-RB5.08HXXB-D系列

MCS连接器附件 MCS connector accessory

护线板Protection plate	订货号Order NO.	间距Pitch	宽度Width	通道数Poles No.	匹配型号Apply ID
	435XXX/100	3.5mm	6mm 12.5mm	2-3 4-6	MCS435针/孔连接器系列 MCS435 female/male series
	438XXX/100	3.81mm	25mm 35mm	7-9 10-12	MCS438针/孔连接器系列 MCS438 female/male series
	450XXX/100	5.0mm	6mm 12.5mm 25mm 35mm	2-3 4-6 7-9 10-12	MCS450针/孔连接器系列 MCS450 female/male series
	458XXX/100	5.08mm			MCS458针/孔连接器系列 MCS458 female/male series
	475XXX/100	7.5mm			MCS475针/孔连接器系列 MCS475 female/male series

注: 护线板可在工厂安装也可自行安装, 该类更多信息请电话咨询! Note: Factory installation or self installation with Protection plate, For more information, please call us directly





护线盒Relief housing	订货号Order NO.	间距Pitch	宽度Width	通道数Poles No.	匹配型号Apply ID
	43555X	3.5mm	-	4-6	MCS435针/孔连接器系列 MCS435 female/male series
	4505XX	5.0mm	-	2-12	MCS450针/孔连接器系列 MCS450 female/male series
	4585XX	5.08mm	-	2-12	MCS458针/孔连接器系列 MCS458 female/male series
	47550X	7.5mm	-	2 3 7	MCS475针/孔连接器系列 MCS475 female/male series

跨接桥Jumper	订货号Order NO.	间距Pitch	宽度Width	通道数Poles No.	匹配型号Apply ID
 450绝缘型相邻跨接桥 Sp450 Insulated type adjacent jumper	450012	5.0mm	-	2	MCS450针/孔连接器系列 MCS450 female/male series
 绝缘型2插脚梳状跨接桥 2 way insulation comb jumper	225332	5.0mm	-	2	MCS450针/孔连接器系列 MCS450 female/male series
 绝缘型3插脚梳状跨接桥 3 way insulation comb jumper	225333	5.0mm	-	3	MCS450针/孔连接器系列 MCS450 female/male series

导轨转换器Rail transfer	订货号Order NO.	间距Pitch	宽度Width	通道数Poles No.	匹配型号Apply ID
	450018	-	-	-	MCS450/475连接器系列 MCS450 /475 series

拨码元件Coding key	订货号Order NO.	间距Pitch	宽度Width	通道数Poles No.	匹配型号Apply ID
	435015	3.5/3.81mm	-	-	MCS435/438系列带焊针插座的连接器 MCS435/ 438 header with solder pins
	450015	5.0/5.08mm	-	-	MCS450/458系列带焊针插座的连接器 MCS450/ 458 header with solder pins
	475015	7.5/7.62mm	-	-	MCS475/478系列带焊针插座的连接器 MCS475/ 478 header with solder pins

标记字符 Marked Numbers

打印字符描述 Description of marked numbers	产品 Product	正面打印字符 Front side marking	双面字符打印型号 Two-side marking		打印字符描述 Description of marked numbers	产品 Product	正面打印字符 Front side marking	双面字符打印型号 Two-side marking	
			孔型 Female type	针型 Male type				孔型 Female type	针型 Male type
1 2 3 4 ... 23 24		/001	/006	/007	1 2 3 4 ... 23 24		/003	-	-
1 2 ⊕ 4 ... 23 24		/002	/008	/009	1 2 ⊕ 4 ... 23 24		/004	-	-

可按客户要求打印字符，下表字符打印在原定货号后加后缀。
For more product information, please contact us! Can mark according to customer's request. The number in the below list can be added following the original order No. /005按客户要求而定 According to customers' request.

大电流穿墙端子附件 Panel feed-through terminal block with high current accessory

法兰板Flange plates	订货号Order NO.	间距Pitch	厚度Compatibility	通道数Poles No.	匹配型号Apply ID
 法兰板, 适用于带安装型穿墙端子 Flange plates, apply for feed-through terminal with mounting pin	SCWH4-F		3mm		SCWH10S
	SCWH10-F		3mm		SCWH10S
	SCWH16-F		3mm		SCWH16S
	SCWH25-F		4mm		SCWH25S

标记牌Marker card	订货号Order NO.	间距Pitch	宽度Width	通道数Poles No.	匹配型号Apply ID
	306801	8.1mm	-	-	SCWH4/SCWH4S
	TMB10.2-10	10.1mm	-	-	SCWH10/SCWH10S
	TMB10.2-10	12mm	-	-	SCWH16/SCWH16S
	TMB10.2-10	15mm	-	-	SCWH25/SCWH25S

跨接桥Jumper	订货号Order NO.	间距Pitch	宽度Width	通道数Poles No.	匹配型号Apply ID
	TJB8.2-2.....TJB8.2-10	-	-	2-10	SCWH4/SCWH4S
	TJB10.2-2.....TJB10.2-10	-	-	2-10	SCWH10/SCWH10S

变压器专用端子附件 Transformer terminal blocks accessory

变压器固定器Transformer End stop	订货号Order NO.	间距Pitch	宽度Width	通道数Poles No.	匹配型号Apply ID
	620301	-	-	-	MCS450 /475 series Transformer terminal blocks

变压器标记牌Transformer Marker card





此端子标记牌适用于端子排垂直放置，每片6条，每条顺序排列10个数字，用于SP620系列端子的标记。
This marker card is applied for terminal strip placed vertically, 6 lines in each piece, and 10 ordered numbers in 1 line, used for marking SP620 connectors.

每片内容 Printed on each piece	订货号 Order NO.	每包数量(片) Number in each pack(piece)
1...10 (10x)	620801/301	5
11...20 (10x)	620801/302	5
21...30 (10x)	620801/303	5
...
91...100 (10x)	620801/310	5
1...50 (2x)	620801/401	5
51...100 (2x)	620801/402	5
SP620空白标记牌 blank marker card	620801	

如需指定特殊字符打印，请咨询销售工程师，谢谢！
If special print needed, please contact our sales manager. Thanks.

弹簧接线端子专用工具 Special tools for spring terminal blocks

简易连线工具Easy connect tool	订货号Order NO.	间距Pitch	通道数Poles No.	匹配型号Apply ID
 简易连线工具(金属) Easy connect tool (metal)	435013	-	-	MCS435、438针/孔连接器系列 MCS435、438 female/male series
	450021	-	-	MCS450、458、475、478针/孔连接器系列 MCS450、458、475、478 female/male series
 新型简易连线工具(金属) Easy connect tool (metal)	450023	-	-	MCS450、458、475、478针/孔连接器系列 MCS450、458、475、478 female/male series
	450014	-	-	MCS450、475针/孔连接器系列 MCS450、475 female/male series

插棒connect bar	规格说明Description	间距Pitch	订货号Order NO.
	1A型单脚插棒 1A type 1 way connect bar	5.0	910111
	2A型双脚插棒 2A type 2 way connect bar	5.0	910112
	10A型十脚插棒 10 way connect bar	5.0	910120

一字螺丝刀 Screwdriver	刀口 Edge	订货号Order NO.
	2.5x0.4mm	910024
	3.5x0.5mm	910025
	5.5x0.8mm	910026