

EDK, Aluminum Electrolytic, 47 uF, 20%, 16 VDC, -40/+85°C

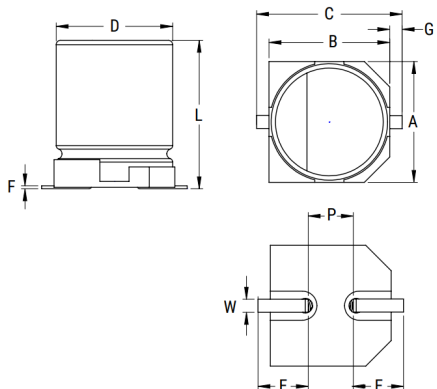

Dimensions	
D	5mm +/-0.5mm
L	5.4mm +0.25/-0.1mm
W	0.65mm +/-0.1mm
F	0.3mm MAX
A	5.3mm +/-0.2mm
B	5.3mm +/-0.2mm
C	6.5mm MAX
E	2.2mm +/-0.2mm
G	0.35mm +0.15/-0.2mm
P	1.5mm +/-0.2mm

Packaging Specifications	
Packaging:	T&R, 380mm
Packaging Quantity:	1000

General Information	
Series:	EDK
Dielectric:	Aluminum Electrolytic
Style:	SMD Can
Description:	Surface Mount, Aluminum Electrolytic
RoHS:	Yes
Lead:	V-Chip
AEC-Q200:	No

Specifications	
Capacitance:	47 uF
Capacitance Tolerance:	20%
Voltage DC:	16 VDC, 20 VDC (Surge)
Temperature Range:	-40/+85°C
Rated Temperature:	85°C
Life:	2000 Hrs
Dissipation Factor:	16%
Ripple Current:	45 mAmps (120Hz), 61.2 mAmps (120Hz 50C)
Leakage Current:	7.5 uA (2min 20°C)
Impedance Ratio at -25C:	2
Impedance Ratio at -40C:	4
High Temperature Solder:	Yes