

# VISIBLE LIGHT PRODUCTS SPECIFICATION

## HPLB-59K15xWx



High Power 15W LED Module

Drawn by	Checked by	Approved by



DATE:2009/10/14

REV:D

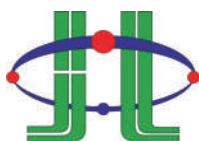

**HUEY JANN ELECTRONICS INDUSTRY CO., LTD.**

No.27 Line 466 Sec.2,Cannng-nan Rd. Wu-chi Town Taichung Shien, Taiwan, R.O.C.

TEL:+886-4-26393976 FAX:+886-4-26393125

HUEY JANN High Power 15W LED Module is made of hi-eff AS/TS GaInN chips with precise package technique which makes excellent heat dissipation to reach the advantages of high luminous efficiency, low decay, and long endurance. Now we have these colors available: red, green, blue, white, yellow and infrared.

#### FEATERUS

- Instant light
- Long operating life
- Superior ESD defense
- Low voltage DC operated
- More energy efficient than incandescent and most halogen lamps

#### TYPICAL APPLICATIONS

- Architectural detail lighting
- Portable flashlight
- Reading lights
- Medical applications
- LCD backlights
- Beacon lights
- Decoration lights

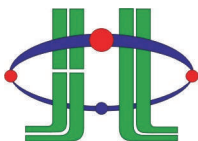

**HUEY JANN ELECTRONICS INDUSTRY CO., LTD.**

No.27 Line 466 Sec.2,Cannng-nan Rd. Wu-chi Town Taichung Shien, Taiwan, R.O.C.

TEL:+886-4-26393976 FAX:+886-4-26393125

Explanation of Part Number:

H   P   LB   -   5   9K   15   xWx  
 ①   ②   ③     ④   ⑤   ⑥   ⑦

1.H: Huey Jann

2.P: High power LED Type

3.Shape distinguish:

LB: Light Bar

4. Lens appearance:

4:Water Clear

5:White Diffusion

5. Color number:

3K: Green

4K: Yellow

5K: Red

8K: Blue

9K: White

6. Power type:

15: 15W

30: 30W

7. Color kind:

BW: Cool White

W: Pure White

NW: Nature White

YW: Warm White

BWG: Cool White

WG: Pure White

NWG: Nature White

YWG: Warm White

DEVICES

Item	Lens Color	Dice Source	Color
HPLB-59K15BW	White Diffusion	GaInN/GaN	Cool White
HPLB-59K15BWG			Cool White
HPLB-59K15W			Pure White
HPLB-59K15WG			Pure White
HPLB-59K15NW			Nature White
HPLB-59K15NWG			Nature White
HPLB-59K15YW			Warm white
HPLB-59K15YWG			Warm white

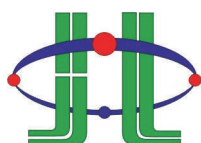

**HUEY JANN ELECTRONICS INDUSTRY CO., LTD.**

No.27 Line 466 Sec.2,Cannng-nan Rd. Wu-chi Town Taichung Shien, Taiwan, R.O.C.

TEL:+886-4-26393976    FAX:+886-4-26393125

PACKAGE DIMENSIONS:

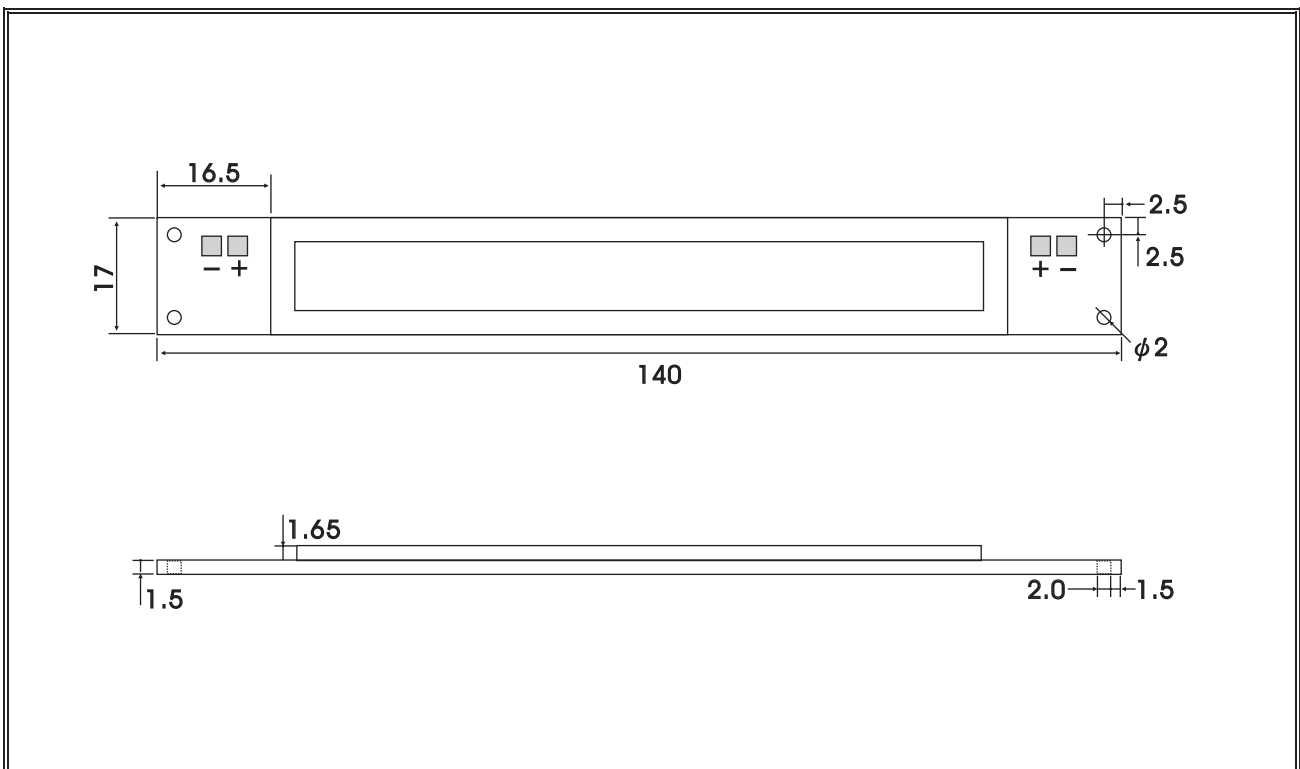

NOTE:

- 1.All dimensions are in millimeter.
- 2.Lead spacing is measured where the lead emerge from the package.
- 3.protruded resin under flange is 1.5mm max.
- 4.specifications are subject to change without notice.
- 5.Tolerance is 0.3mm unless otherwise noted.
- 6.Driving LED without heat sinking device is forbidden.
- 7.It is strongly recommended that the temperature of lead be not higher than 55°C.
- 8.Proper current derating must be observed to maintain junction temperature below the maximum.
- 9.LEDs are not designed to be driven in reserve bias.
10. Warps the degree 0.5mm.

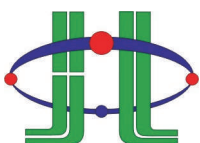

**HUEY JANN ELECTRONICS INDUSTRY CO., LTD.**

No.27 Line 466 Sec.2,Cannng-nan Rd. Wu-chi Town Taichung Shien, Taiwan, R.O.C.

TEL:+886-4-26393976 FAX:+886-4-26393125

**ABSOLUTE MAXIMUM RATINGS**

TA=25°C

PARAMETER	SYMBOL	MAX. RATING	UNIT
Continuous Forward Current	IF	1400	mA
Peak Forward Current *1	IFM	1500	mA
Electrostatic Discharge (HBM)	ESD	4000	V
LED Junction Temperature	Tj	135	°C
Operating Temperature	Topr	-40 ~ +110	°C
Storage Temperature	Tstg	-40 ~ +120	°C
Manual Soldering Temperature 260 °C for 5 seconds max. *2			

\*1.Duty Ratio=0.1%,Pulse Width=10us.

\*2.Iron soldering high temperature will not cause damage to the dice. But be aware of the high temperature will not only make the epoxy soften but also cause the lead moving and the gold wire broken and even open. So before returning to the normal temperatures PLEASE AVOID any serious pressure on the top of epoxy and lead.

\*3. We suggest using PWM (Pulse Width Modulation) for driving.

\*4. It is recommended to use series as there are several 3pcs. If there are more than 5pcs, please use product with higher power.

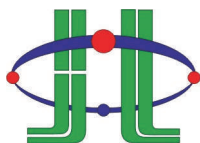

**HUEY JANN ELECTRONICS INDUSTRY CO., LTD.**

No.27 Line 466 Sec.2,Cannng-nan Rd. Wu-chi Town Taichung Shien, Taiwan, R.O.C.

TEL:+886-4-26393976 FAX:+886-4-26393125

ELECTRIC-OPTICAL CHARACTERISTICS

TA=25°C

PARAMETER	SYMBOL	TEST CONDITION	MIN	TYP	MAX	UNIT
View Angle of Half Power	2θ <sub>1/2</sub>	IF=1400mA		120		deg
Forward Voltage	V <sub>F</sub>			10.5	12.0	V
Color Rendering Index	CRI			85		
Thermal Resistance Junction To Case	R <sub>θ J-C</sub>			2.8		°C/W
Temperature Coefficient Of Forward Voltage	ΔV <sub>F</sub> /ΔT				-2	mV/°C

ELECTRIC-OPTICAL CHARACTERISTICS FOR LUMINOUS INTENSITY

TA=25°C

ITEM	SYMBOL	TEST CONDITION	MIN	TYP	MAX	UNIT
HPLB-59K15BW	IV	IF=1400mA		1017		lm
HPLB-59K15BWG				1088		
HPLB-59K15W				1017		
HPLB-59K15WG				1088		
HPLB-59K15NW				988		
HPLB-59K15NWG				1057		
HPLB-59K15YW				915		
HPLB-59K15YWG				980		

\*Tolerance: 15% HUEY-JANN measuring equipment : EXELTRON 2001. 2.S370 made by U.D.T.

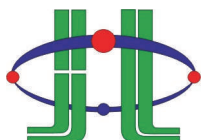

**HUEY JANN ELECTRONICS INDUSTRY CO., LTD.**

No.27 Line 466 Sec.2,Cannng-nan Rd. Wu-chi Town Taichung Shien, Taiwan, R.O.C.

TEL:+886-4-26393976 FAX:+886-4-26393125

ELECTRIC-OPTICAL CHARACTERISTICS FOR COLOR TEMPERATURE

TA=25°C

ITEM	SYMBOL	TEST CONDITION	TYP	UNIT
HPLB-59K15BW	CCT	IF=1400mA	8000	°K
HPLB-59K15BWG				
HPLB-59K15W			6000	
HPLB-59K15WG				
HPLB-59K15NW			4000	
HPLB-59K15NWG				
HPLB-59K15YW			3300	
HPLB-59K15YWG				

\*Tolerance: 15% HUEY-JANN measuring equipment : EXELTRON 2001. 2.S370 made by U.D.T.

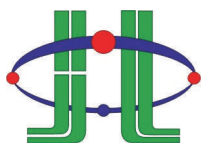

**HUEY JANN ELECTRONICS INDUSTRY CO., LTD.**

No.27 Line 466 Sec.2,Cannng-nan Rd. Wu-chi Town Taichung Shien, Taiwan, R.O.C.

TEL:+886-4-26393976 FAX:+886-4-26393125

RELIABILITY TEST

Endurance Test

Test Item	Reference Standard	Test Conditions	Result
Operation Life	MIL-STD-750:1026 MIL-STD-883:1005 JIS-C-7021 :B-1	Connect with a power if=1400mA Ta=Under room temperature Test Time=1,000hrs	0/22
High Temperature High Humidity Storage	MIL-STD-202:103B JIS-C-7021 :B-11	Ta=+85°C 5°C RH=80% ~ 85% Test Time=1,000hrs	0/22
High Temperature Storage	MIL-STD-883:1008 JIS-C-7021 :B-10	High Ta=+120°C 5°C Test Time=1,000hrs	0/22
Low Temperature Storage	JIS-C-7021 :B-12	Low Ta=-40°C 5°C Test Time=1,000hrs	0/22

\*Failure Criteria:

1. VF arise  $\geq 10\%$
2. IV decline  $\geq 30\%$
3. A failure is an LED that is open or shorted

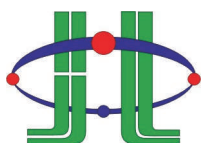

**HUEY JANN ELECTRONICS INDUSTRY CO., LTD.**

No.27 Line 466 Sec.2,Canng-nan Rd. Wu-chi Town Taichung Shien, Taiwan, R.O.C.

TEL:+886-4-26393976 FAX:+886-4-26393125



RELIABILITY TEST

➤ Environmental Test

Test Item	Reference Standard	Test Conditions	Result
Temperature Cycling	MIL-STD-202:107D MIL-STD-750:1051 MIL-STD-883:1010 JIS-C-7021 :A-4	-40°C ~ +25°C ~ +85°C ~ +25°C 60min 20min 60min 20min Test Time=200cycle	0/22
Thermal Shock	MIL-STD-202:107D MIL-STD-750:1051 MIL-STD-883:1010	-40°C 5°C ~ +110°C 5°C 20min 20min Test Time=200cycle	0/22

\*Failure Criteria:

1. VF arise  $\geq 10\%$
2. IV decline  $\geq 30\%$
3. A failure is an LED that is open or shorted

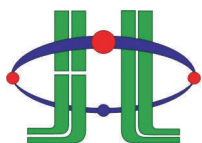

**HUEY JANN ELECTRONICS INDUSTRY CO., LTD.**

No.27 Line 466 Sec.2,Canng-nan Rd. Wu-chi Town Taichung Shien, Taiwan, R.O.C.

TEL:+886-4-26393976 FAX:+886-4-26393125

TYPICAL ELECTRICAL OPTICAL CHARACTERISTICS CURVES

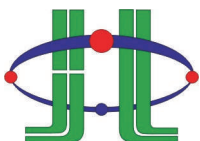
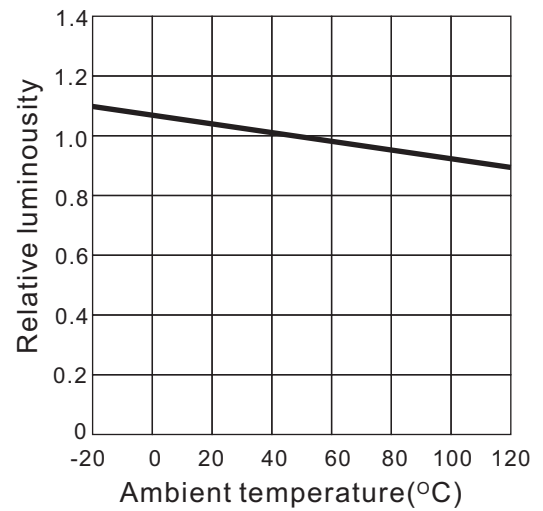
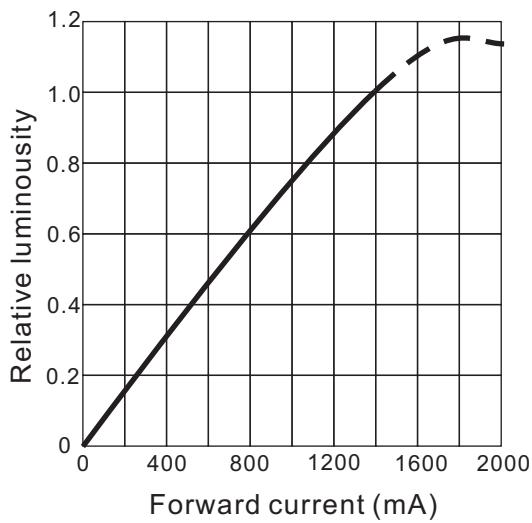
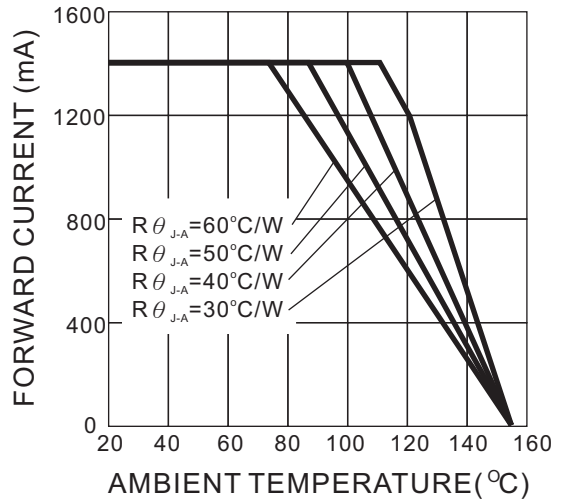
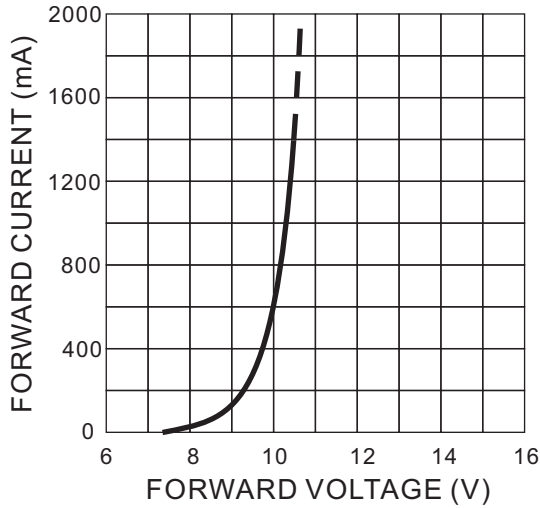

**HUEY JANN ELECTRONICS INDUSTRY CO., LTD.**

No.27 Line 466 Sec.2,Cannng-nan Rd. Wu-chi Town Taichung Shien, Taiwan, R.O.C.

TEL:+886-4-26393976 FAX:+886-4-26393125

TYPICAL ELECTRICAL OPTICAL CHARACTERISTICS CURVES

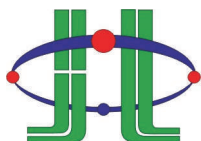
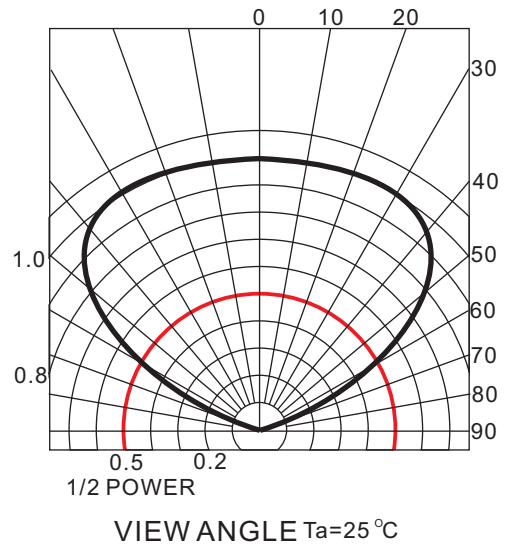
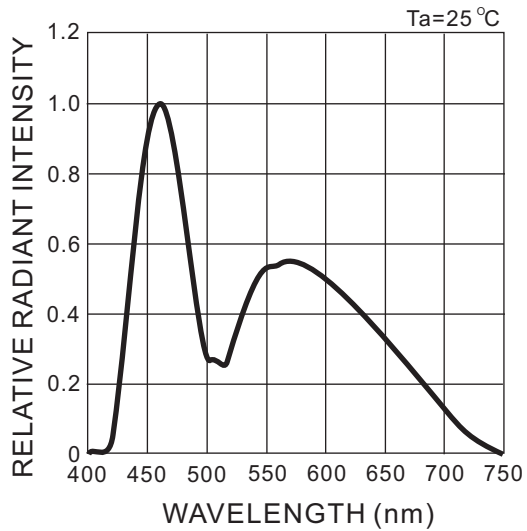
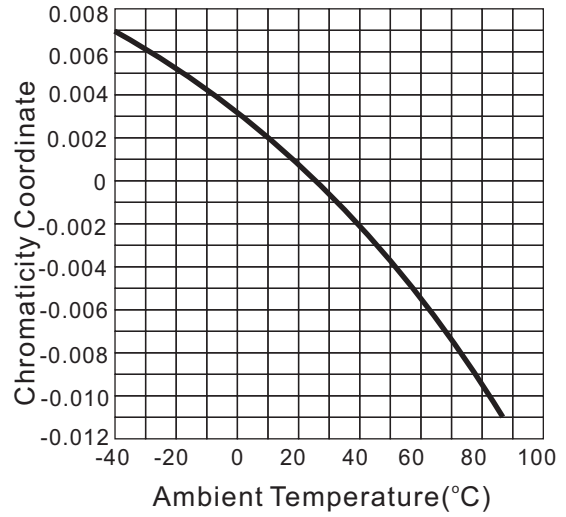
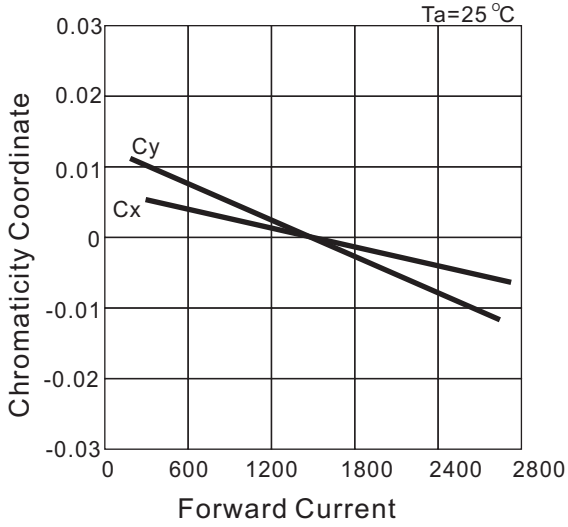

**HUEY JANN ELECTRONICS INDUSTRY CO., LTD.**

No.27 Line 466 Sec.2,Canng-nan Rd. Wu-chi Town Taichung Shien, Taiwan, R.O.C.

TEL:+886-4-26393976 FAX:+886-4-26393125

Cool White Color Bin Selection

CCT(°K)	Chromaticity Coordinates				
TYP					
8000	x	0.274	0.303	0.311	0.290
	y	0.301	0.333	0.293	0.270
Tolerance		$x \pm 0.02$			$y \pm 0.02$

Cool White CIE Light Color Chart

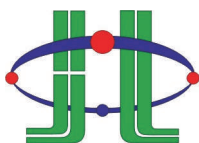
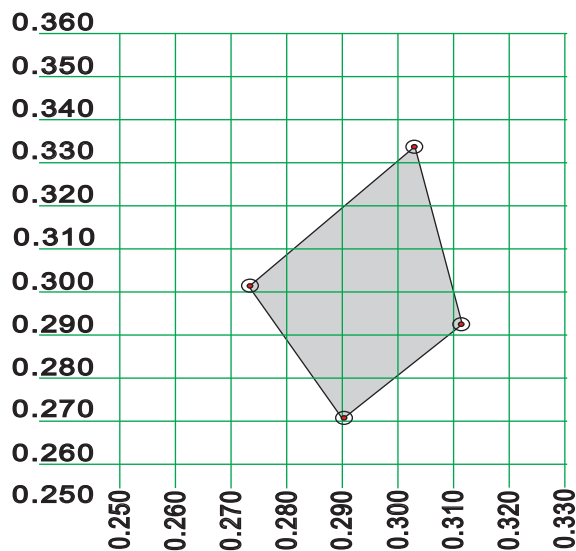

**HUEY JANN ELECTRONICS INDUSTRY CO., LTD.**

No.27 Line 466 Sec.2, Canning-nan Rd. Wu-chi Town Taichung Shien, Taiwan, R.O.C.

TEL:+886-4-26393976 FAX:+886-4-26393125

Pure White Color Bin Selection

CCT(°K)	Chromaticity Coordinates				
TYP					
6000	x	0.301	0.329	0.329	0.311
	y	0.342	0.369	0.310	0.293
Tolerance		x ± 0.02		y ± 0.02	

Pure White CIE Light Color Chart

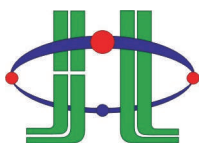
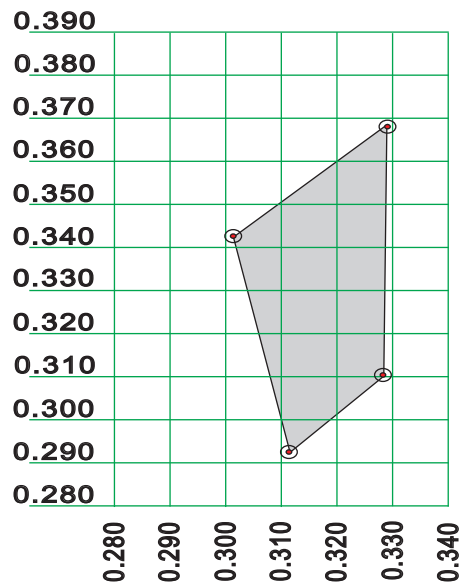

**HUEY JANN ELECTRONICS INDUSTRY CO., LTD.**

No.27 Line 466 Sec.2, Cangg-nan Rd. Wu-chi Town Taichung Shien, Taiwan, R.O.C.

TEL:+886-4-26393976 FAX:+886-4-26393125

☰ Nature White Color Bin Selection

CCT(°K)		Chromaticity Coordinates			
TYP					
4000	x	0.367	0.420	0.396	0.357
	y	0.400	0.432	0.367	0.342
Tolerance		$x \pm 0.02$		$y \pm 0.02$	

☰ Nature White CIE Light Color Chart

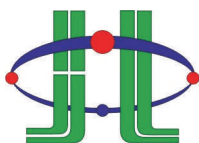
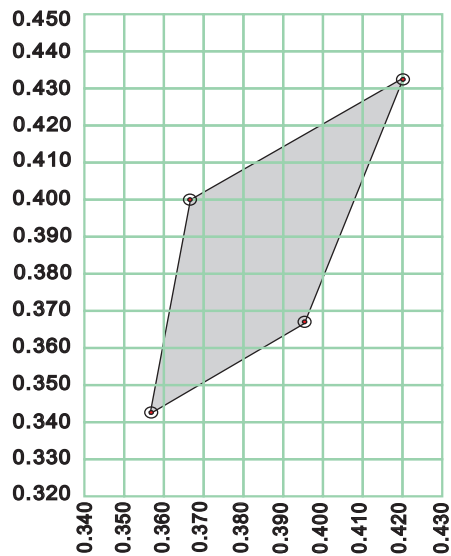

**HUEY JANN ELECTRONICS INDUSTRY CO., LTD.**

No.27 Line 466 Sec.2, Cangg-nan Rd. Wu-chi Town Taichung Shien, Taiwan, R.O.C.

TEL:+886-4-26393976 FAX:+886-4-26393125

Warm White Color Bin Selection

CCT(K)	Chromaticity Coordinates						
TYP							
3300	x	0.402	0.454	0.429	0.416	0.410	0.383
	y	0.423	0.446	0.394	0.389	0.374	0.360
<b>Tolerance</b>		<b>x ± 0.02</b>			<b>y ± 0.02</b>		

Warm White CIE Light Color Chart

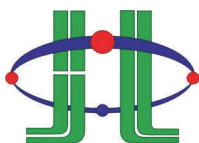
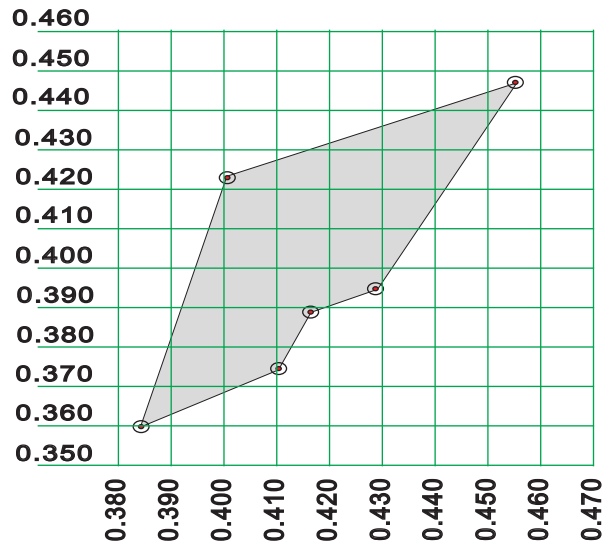

**HUEY JANN ELECTRONICS INDUSTRY CO., LTD.**

No.27 Line 466 Sec.2, Canning Rd. Wu-chi Town Taichung Shien, Taiwan, R.O.C.

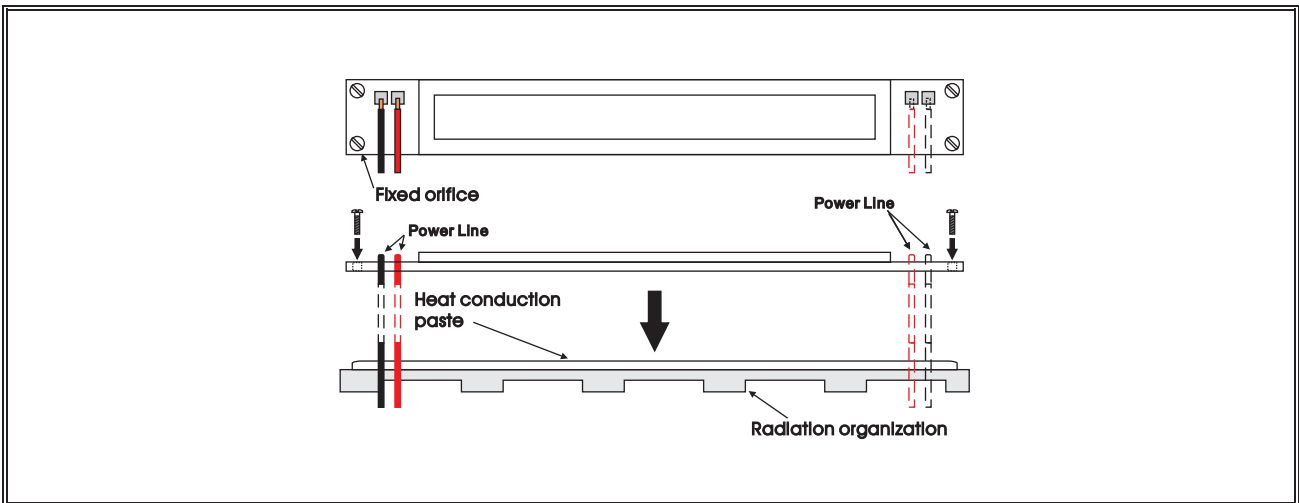

TEL:+886-4-26393976 FAX:+886-4-26393125

POSITION EXPLANATION:



Conclusion

Huey Jann provide simple comparison table for High Power LED, you could find your request heat dissipation area from the following table.

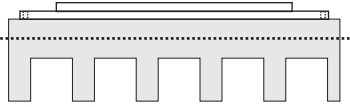
	 Free Convection Horizontal Flat Heat Dissipation-Set-up ( Area Require mm <sup>2</sup> )	 Free Convection Vertical Flat Heat Dissipation-Set-up ( Area Require mm <sup>2</sup> )	 Free Convection Finned Heat Dissipation-Set-up ( Area Require mm <sup>2</sup> )
15W	18,500	14,000	64,500

\*TAB in this table is according to highest operating temperature 65°C.

\*Different materials of second heat dissipation device, the surface area of heat sink will be different. Thus, this document is for reference only.

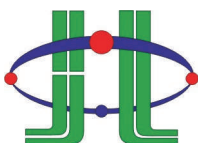

**HUEY JANN ELECTRONICS INDUSTRY CO., LTD.**

No.27 Line 466 Sec.2,Cannng-nan Rd. Wu-chi Town Taichung Shien, Taiwan, R.O.C.

TEL:+886-4-26393976 FAX:+886-4-26393125



PRODUCT APPLICATION

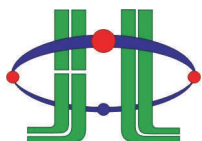
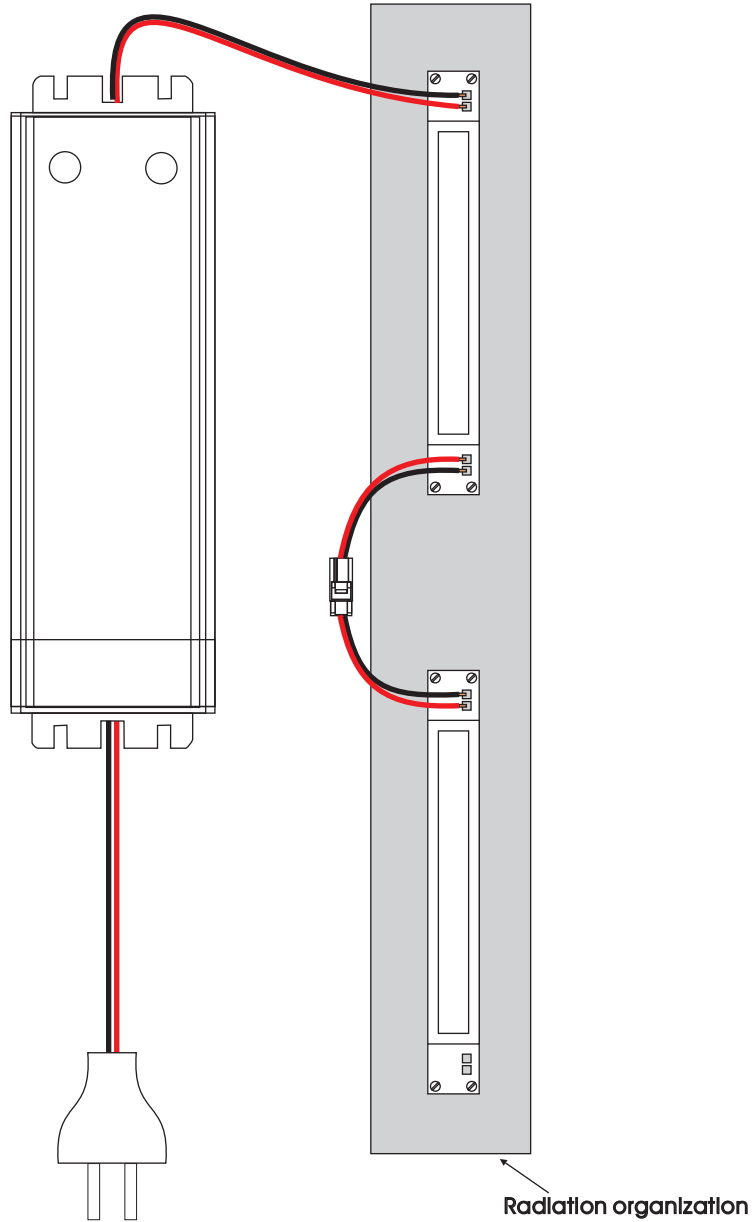

**HUEY JANN ELECTRONICS INDUSTRY CO., LTD.**

No.27 Line 466 Sec.2,Cannng-nan Rd. Wu-chi Town Taichung Shien, Taiwan, R.O.C.

TEL:+886-4-26393976 FAX:+886-4-26393125

15W Operating Instructions

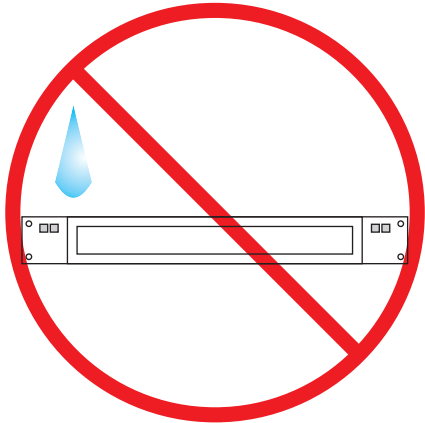

1. It is important to keep away the product from water, in order to avoid the product electronic characteristics to be harmful.

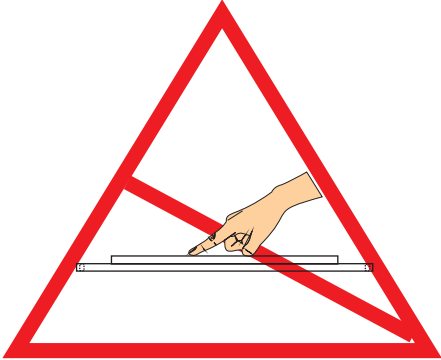

2. When making use of products, it is necessary to use anti-ESD devices to prevent destructive electronic characteristics.

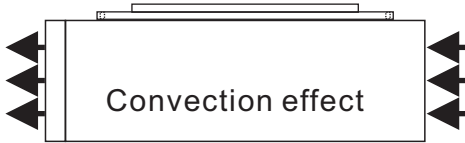

3. It should be noticed whether there is convection in design of device. Convection has to exist.

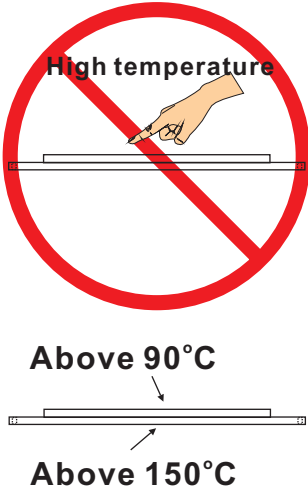

4. There is 150 C directly from the front of 15W emitting diode. It is untouchable to prevent burning.

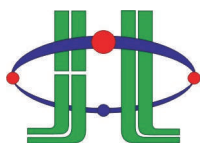

**HUEY JANN ELECTRONICS INDUSTRY CO., LTD.**

No.27 Line 466 Sec.2,Canng-nan Rd. Wu-chi Town Taichung Shien, Taiwan, R.O.C.

TEL:+886-4-26393976 FAX:+886-4-26393125

15W Operating Instructions

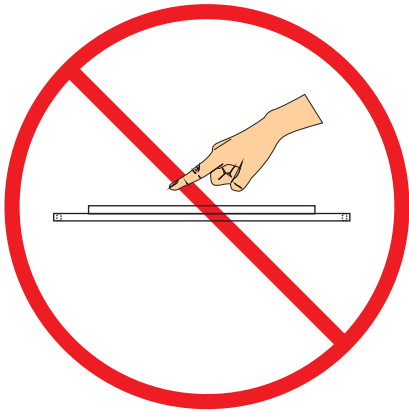

5. The material in the central top of 15W LED is soft. Therefore, it is un-squeezable and untouchable.

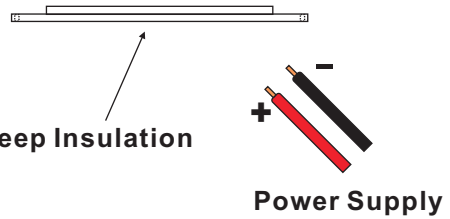

6. In the bottom of heat sink cannot be touched with neither positive nor negative pole. (Heat sink has to be insulation.)

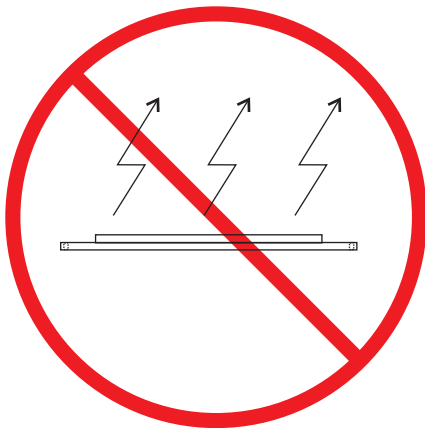

7. The product should not be light up directly without heat dissipation device.

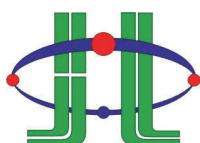

**HUEY JANN ELECTRONICS INDUSTRY CO., LTD.**

No.27 Line 466 Sec.2,Cannng-nan Rd. Wu-chi Town Taichung Shien, Taiwan, R.O.C.

TEL:+886-4-26393976 FAX:+886-4-26393125

TAB Temperature - Life Characteristics Curves

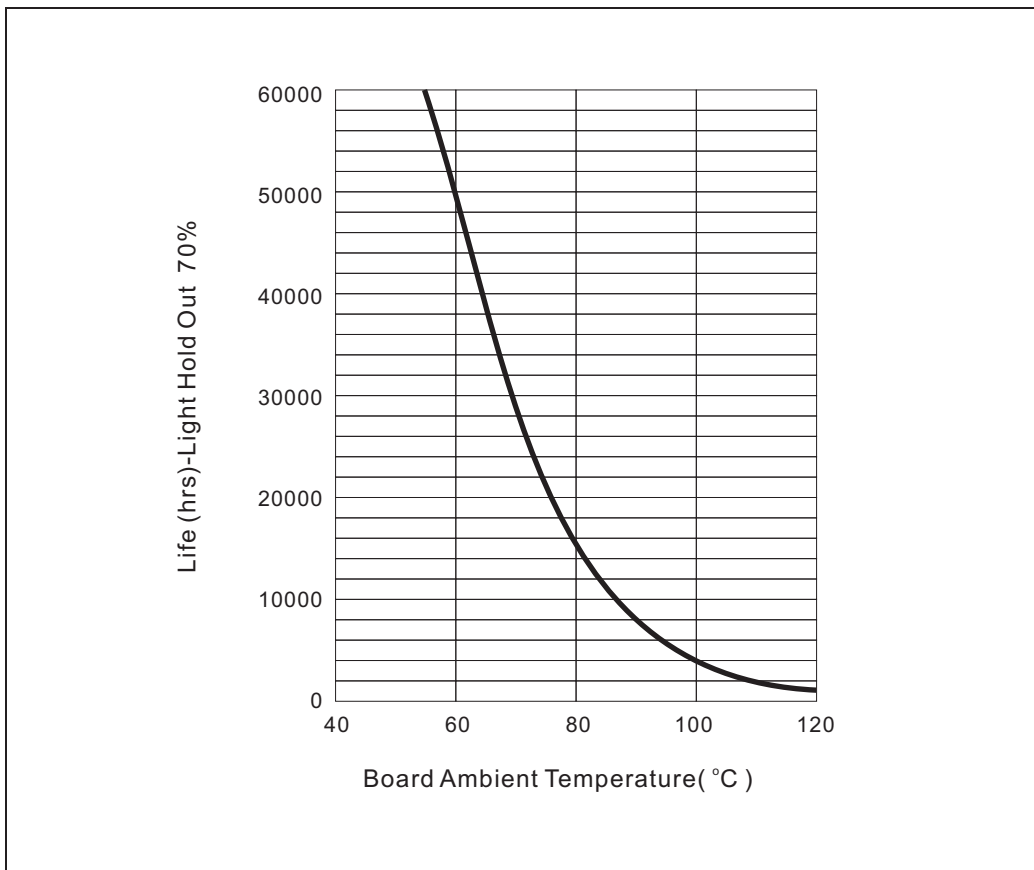
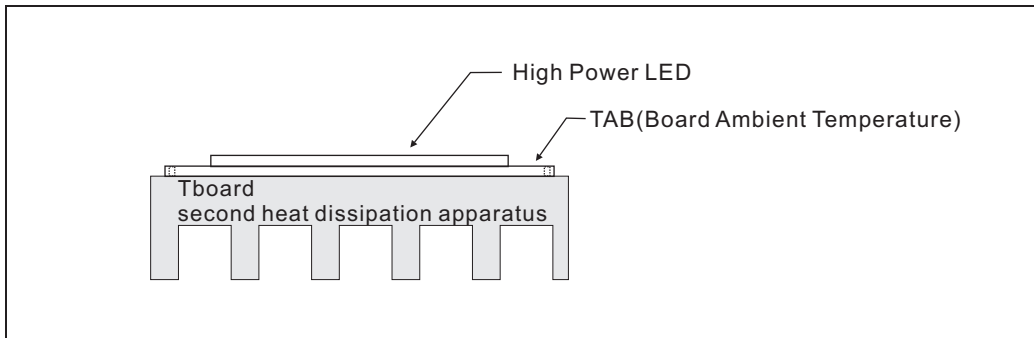

\*Board Ambient Temperature Tolerance  $\pm 5^{\circ}\text{C}$ .

\*The TAB is the stable testing value for the product lighted 100% after one hour.

\*This document is for reference only.

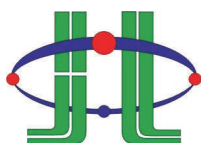

**HUEY JANN ELECTRONICS INDUSTRY CO., LTD.**

No.27 Line 466 Sec.2, Canning-nan Rd. Wu-chi Town Taichung Shien, Taiwan, R.O.C.

TEL:+886-4-26393976 FAX:+886-4-26393125