

# NJL3281D (NPN) NJL1302D (PNP)

## Complementary ThermalTrak™ Transistors

The ThermalTrak family of devices has been designed to eliminate thermal equilibrium lag time and bias trimming in audio amplifier applications. They can also be used in other applications as transistor die protection devices.

### Features

- Thermally Matched Bias Diode
- Instant Thermal Bias Tracking
- Absolute Thermal Integrity
- High Safe Operating Area
- Pb-Free Packages are Available\*

### Benefits

- Eliminates Thermal Equilibrium Lag Time and Bias Trimming
- Superior Sound Quality Through Improved Dynamic Temperature Response
- Significantly Improved Bias Stability
- Simplified Assembly
  - ◆ Reduced Labor Costs
  - ◆ Reduced Component Count
- High Reliability

### Applications

- High-End Consumer Audio Products
  - ◆ Home Amplifiers
  - ◆ Home Receivers
- Professional Audio Amplifiers
  - ◆ Theater and Stadium Sound Systems
  - ◆ Public Address Systems (PAs)



**ON Semiconductor®**

<http://onsemi.com>

**BIPOLAR POWER  
TRANSISTORS**  
**15 AMP, 260 VOLT, 200 WATT**

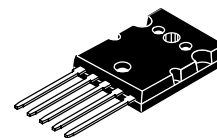

TO-264, 5 LEAD  
CASE 340AA  
STYLE 1

### MARKING DIAGRAM

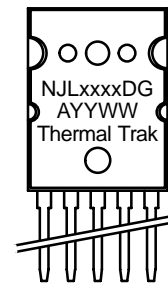

### SCHEMATIC

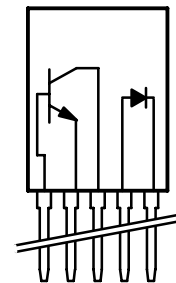

NJLxxxxD = Device Code  
           xxxx = 3281 or 1302  
 G = Pb-Free Package  
 A = Assembly Location  
 YY = Year  
 WW = Work Week

### ORDERING INFORMATION

Device	Package	Shipping
NJL3281D	TO-264	25 Units / Rail
NJL3281DG	TO-264 (Pb-Free)	25 Units / Rail
NJL1302D	TO-264	25 Units / Rail
NJL1302DG	TO-264 (Pb-Free)	25 Units / Rail

\*For additional information on our Pb-Free strategy and soldering details, please download the ON Semiconductor Soldering and Mounting Techniques Reference Manual, SOLDERRM/D.

## NJL3281D (NPN) NJL1302D (PNP)

### MAXIMUM RATINGS (T<sub>J</sub> = 25°C unless otherwise noted)

Rating	Symbol	Value	Unit
Collector–Emitter Voltage	V <sub>CEO</sub>	260	Vdc
Collector–Base Voltage	V <sub>CBO</sub>	260	Vdc
Emitter–Base Voltage	V <sub>EBO</sub>	5	Vdc
Collector–Emitter Voltage – 1.5 V	V <sub>CEX</sub>	260	Vdc
Collector Current – Continuous – Peak (Note 1)	I <sub>C</sub>	15 25	Adc
Base Current – Continuous	I <sub>B</sub>	1.5	Adc
Total Power Dissipation @ T <sub>C</sub> = 25°C Derate Above 25°C	P <sub>D</sub>	200 1.43	W W/°C
Operating and Storage Junction Temperature Range	T <sub>J</sub> , T <sub>stg</sub>	– 65 to +150	°C
DC Blocking Voltage	V <sub>R</sub>	200	V
Average Rectified Forward Current	I <sub>F(AV)</sub>	1.0	A

### THERMAL CHARACTERISTICS

Characteristic	Symbol	Max	Unit
Thermal Resistance, Junction–to–Case	R <sub>θJC</sub>	0.625	°C/W

Stresses exceeding Maximum Ratings may damage the device. Maximum Ratings are stress ratings only. Functional operation above the Recommended Operating Conditions is not implied. Extended exposure to stresses above the Recommended Operating Conditions may affect device reliability.

1. Pulse Test: Pulse Width = 5 ms, Duty Cycle < 10%.

### ATTRIBUTES

Characteristic	Value
ESD Protection Human Body Model Machine Model	>8000 V > 400 V
Flammability Rating	UL 94 V–0 @ 0.125 in

## NJL3281D (NPN) NJL1302D (PNP)

### ELECTRICAL CHARACTERISTICS (T<sub>C</sub> = 25°C unless otherwise noted)

Characteristic	Symbol	Min	Max	Unit
<b>OFF CHARACTERISTICS</b>				
Collector-Emitter Sustaining Voltage (I <sub>C</sub> = 100 mA <sub>dc</sub> , I <sub>B</sub> = 0)	V <sub>CEO(sus)</sub>	260	–	V <sub>dc</sub>
Collector Cutoff Current (V <sub>CB</sub> = 260 V <sub>dc</sub> , I <sub>E</sub> = 0)	I <sub>CB0</sub>	–	50	μA <sub>dc</sub>
Emitter Cutoff Current (V <sub>EB</sub> = 5 V <sub>dc</sub> , I <sub>C</sub> = 0)	I <sub>EBO</sub>	–	5	μA <sub>dc</sub>
<b>ON CHARACTERISTICS</b>				
DC Current Gain (I <sub>C</sub> = 500 mA <sub>dc</sub> , V <sub>CE</sub> = 5 V <sub>dc</sub> ) (I <sub>C</sub> = 1 A <sub>dc</sub> , V <sub>CE</sub> = 5 V <sub>dc</sub> ) (I <sub>C</sub> = 3 A <sub>dc</sub> , V <sub>CE</sub> = 5 V <sub>dc</sub> ) (I <sub>C</sub> = 5 A <sub>dc</sub> , V <sub>CE</sub> = 5 V <sub>dc</sub> ) (I <sub>C</sub> = 8 A <sub>dc</sub> , V <sub>CE</sub> = 5 V <sub>dc</sub> )	h <sub>FE</sub>	75 75 75 75 45	150 150 150 150 –	
Collector-Emitter Saturation Voltage (I <sub>C</sub> = 10 A <sub>dc</sub> , I <sub>B</sub> = 1 A <sub>dc</sub> )	V <sub>CE(sat)</sub>	–	3	V <sub>dc</sub>
<b>DYNAMIC CHARACTERISTICS</b>				
Current-Gain – Bandwidth Product (I <sub>C</sub> = 1 A <sub>dc</sub> , V <sub>CE</sub> = 5 V <sub>dc</sub> , f <sub>test</sub> = 1 MHz)	f <sub>T</sub>	30	–	MHz
Output Capacitance (V <sub>CB</sub> = 10 V <sub>dc</sub> , I <sub>E</sub> = 0, f <sub>test</sub> = 1 MHz)	C <sub>ob</sub>	–	600	pF
Maximum Instantaneous Forward Voltage (Note 2) (i <sub>F</sub> = 1.0 A, T <sub>J</sub> = 25°C) (i <sub>F</sub> = 1.0 A, T <sub>J</sub> = 150°C)	V <sub>F</sub>		1.1 0.93	V
Maximum Instantaneous Reverse Current (Note 2) (Rated dc Voltage, T <sub>J</sub> = 25°C) (Rated dc Voltage, T <sub>J</sub> = 150°C)	i <sub>R</sub>		10 100	μA
Maximum Reverse Recovery Time (i <sub>F</sub> = 1.0 A, di/dt = 50 A/μs)	t <sub>rr</sub>		100	ns

2. Diode Pulse Test: Pulse Width = 300 μs, Duty Cycle ≤ 2.0%.

# NJL3281D (NPN) NJL1302D (PNP)

## TYPICAL CHARACTERISTICS

PNP NJL1302D

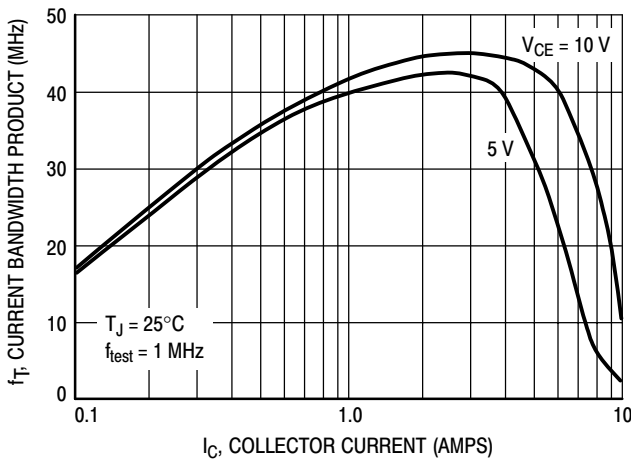

Figure 1. Typical Current Gain Bandwidth Product

NPN NJL3281D

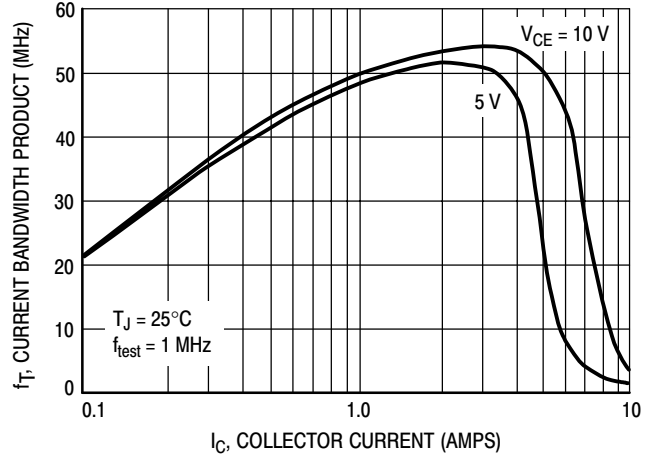

Figure 2. Typical Current Gain Bandwidth Product

PNP NJL1302D

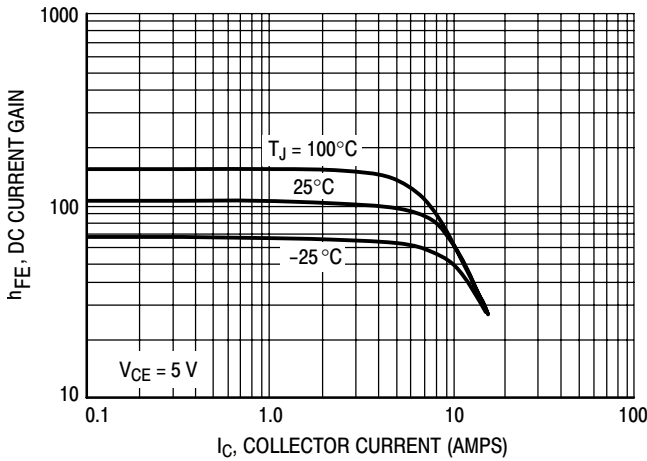

Figure 3. DC Current Gain,  $V_{CE} = 5V$

NPN NJL3281D

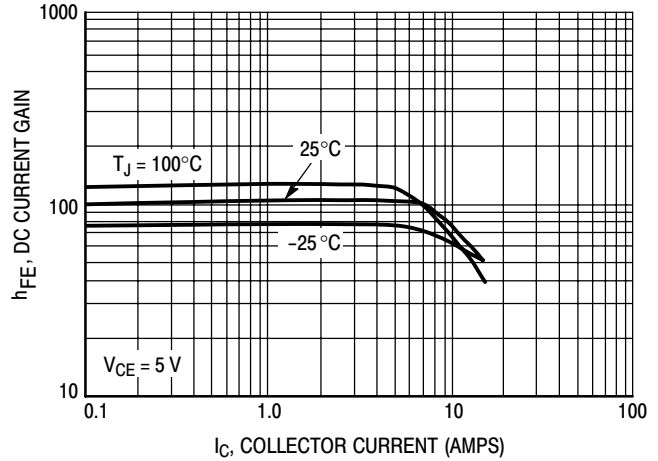

Figure 4. DC Current Gain,  $V_{CE} = 5V$

PNP NJL1302D

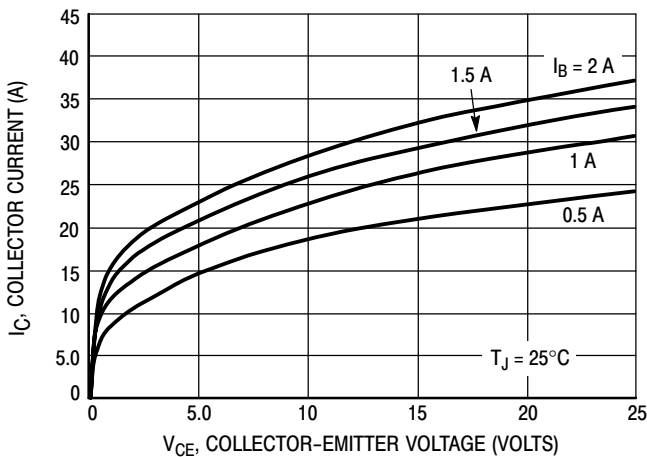

Figure 5. Typical Output Characteristics

NPN NJL3281D

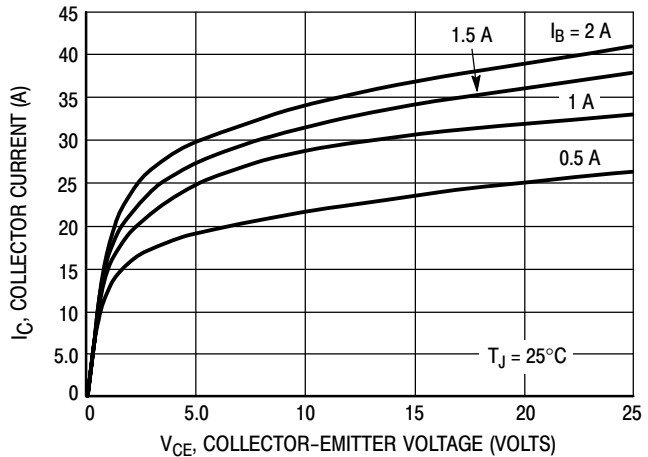

Figure 6. Typical Output Characteristics

# NJL3281D (NPN) NJL1302D (PNP)

## TYPICAL CHARACTERISTICS

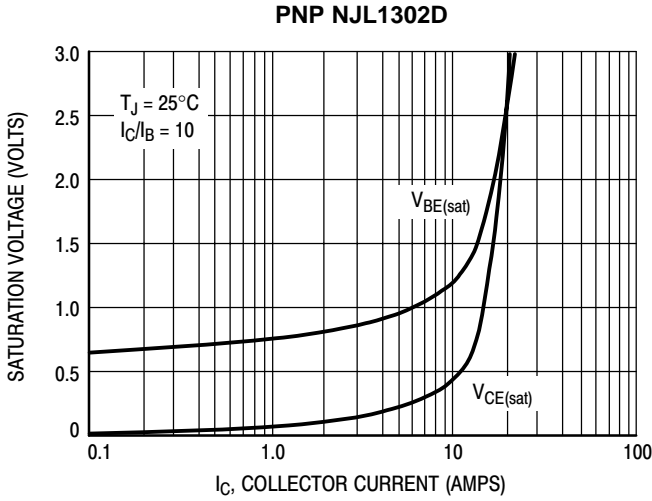

Figure 7. Typical Saturation Voltages

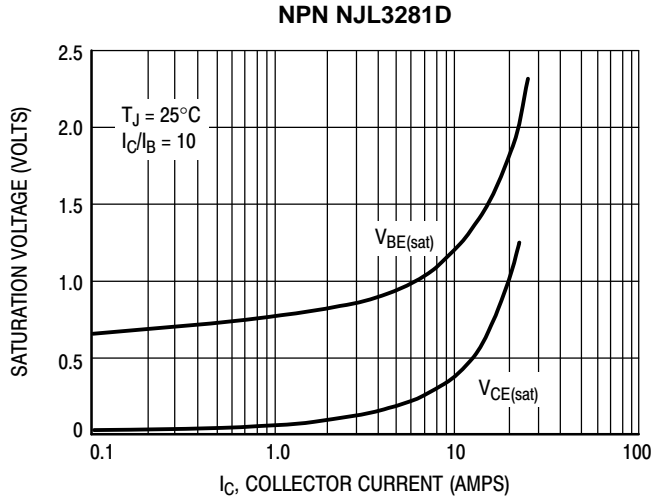

Figure 8. Typical Saturation Voltages

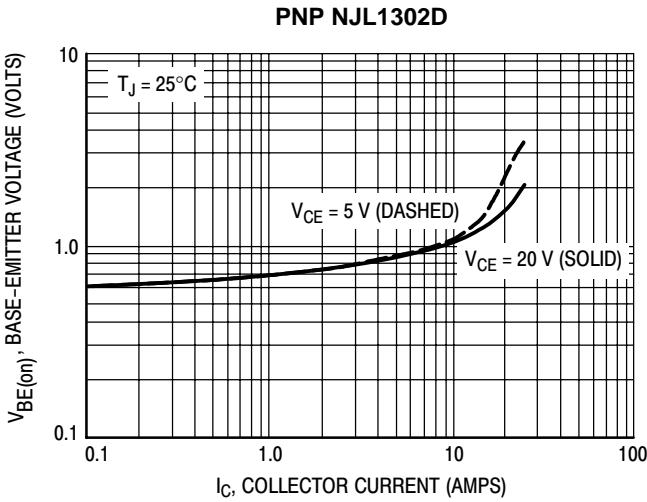

Figure 9. Typical Base-Emitter Voltage

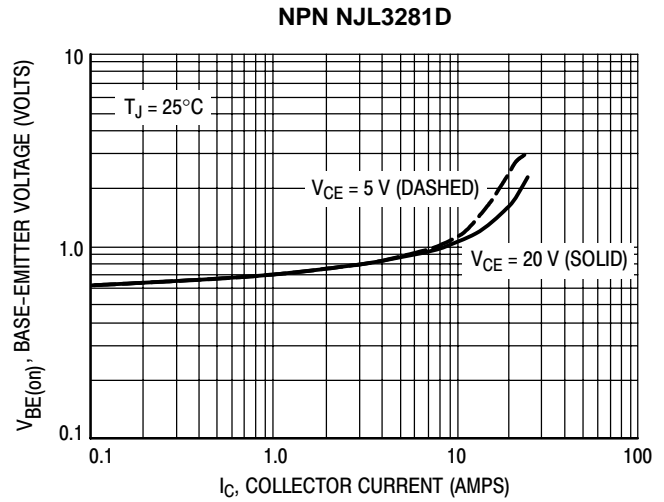

Figure 10. Typical Base-Emitter Voltage

# NJL3281D (NPN) NJL1302D (PNP)

## TYPICAL CHARACTERISTICS

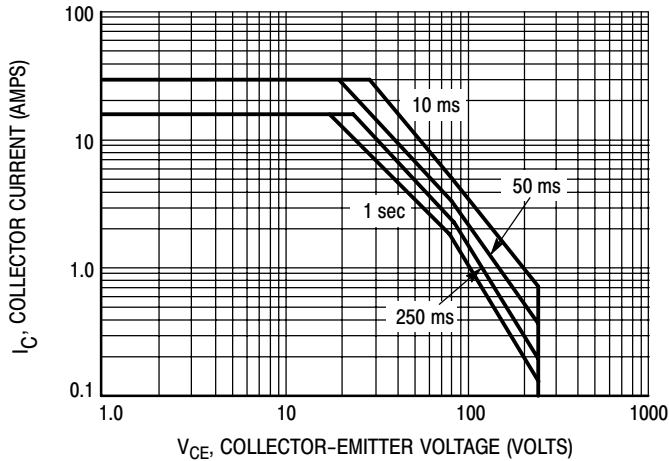

Figure 11. Active Region Safe Operating Area

There are two limitations on the power handling ability of a transistor; average junction temperature and secondary breakdown. Safe operating area curves indicate  $I_C - V_{CE}$  limits of the transistor that must be observed for reliable operation; i.e., the transistor must not be subjected to greater dissipation than the curves indicate.

The data of Figure 11 is based on  $T_{J(pk)} = 150^\circ\text{C}$ ;  $T_C$  is variable depending on conditions. At high case temperatures, thermal limitations will reduce the power than can be handled to values less than the limitations imposed by second breakdown.

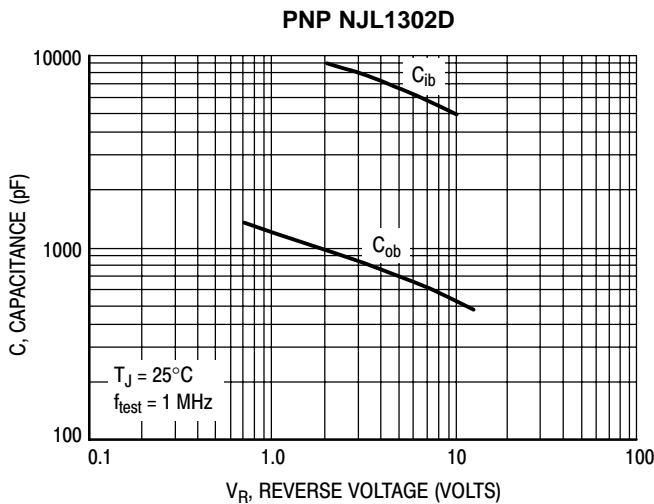

Figure 12. NJL1302D Typical Capacitance

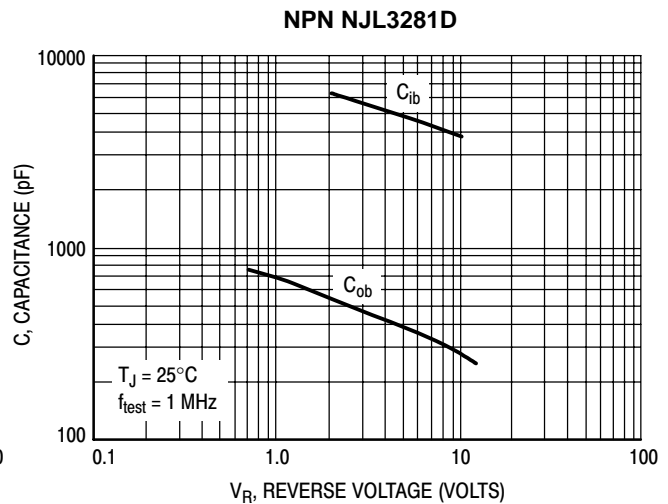

Figure 13. NJL3281D Typical Capacitance

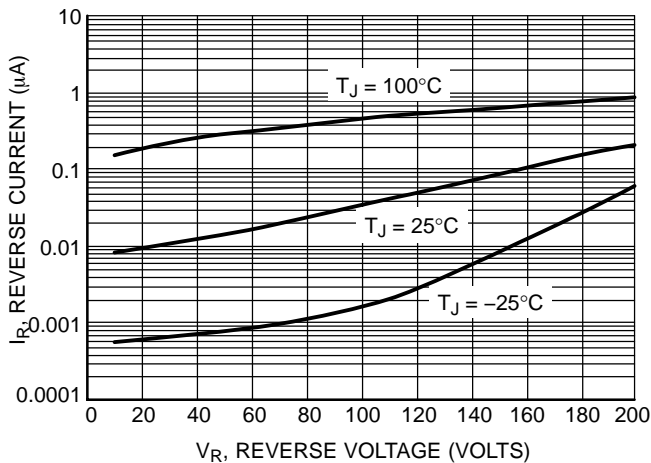

Figure 14. Typical Reverse Current

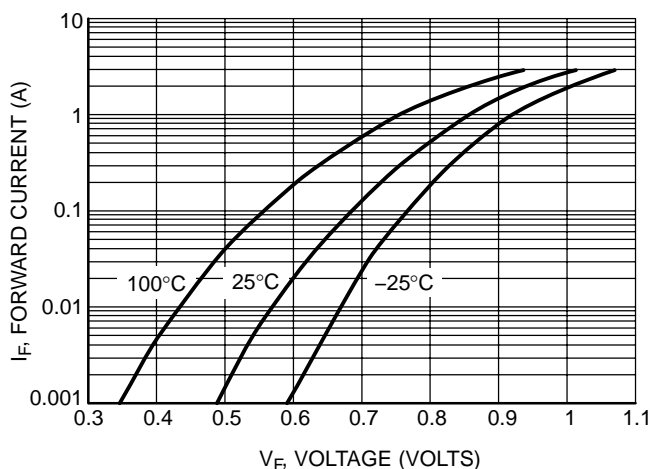

Figure 15. Typical Forward Voltage

# MECHANICAL CASE OUTLINE PACKAGE DIMENSIONS

ON Semiconductor®



TO-264, 5 LEAD  
CASE 340AA-01  
ISSUE O

DATE 03 FEB 2005

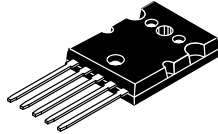

SCALE 1:2

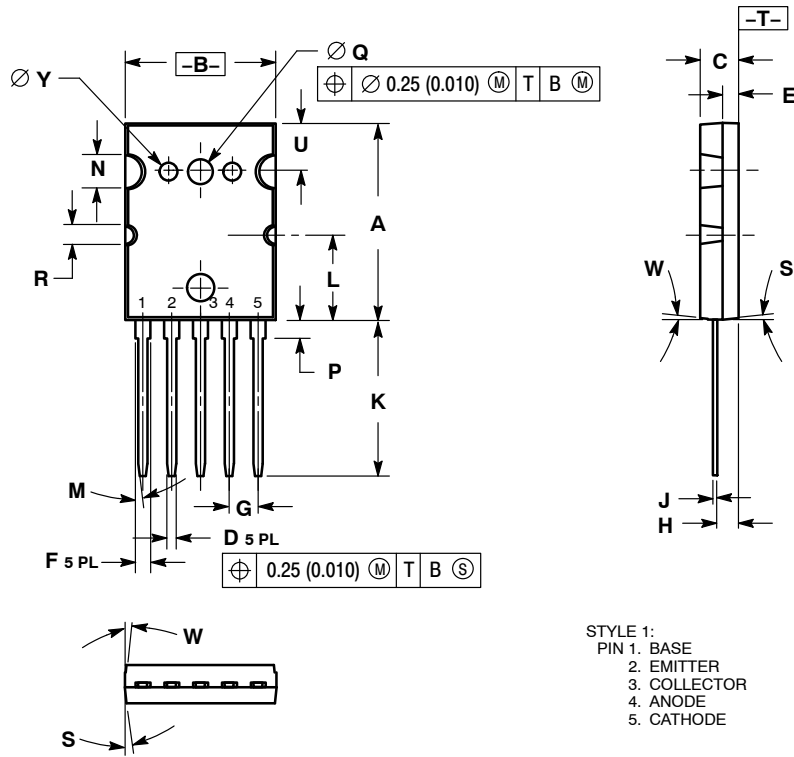

NOTES:  
1. DIMENSIONING AND TOLERANCING PER ANSI Y14.5M, 1982.  
2. CONTROLLING DIMENSION: MILLIMETER.

DIM	MILLIMETERS			INCHES		
	MIN	NOM	MAX	MIN	NOM	MAX
A	25.857	25.984	26.111	1.018	1.023	1.028
B	19.761	19.888	20.015	0.778	0.783	0.788
C	4.699	4.890	5.182	0.185	0.199	0.204
D	1.219 BSC			0.0480 BSC		
E	1.890	2.042	2.184	0.0748	0.0804	0.0860
F	1.981 BSC			0.0780 BSC		
G	3.81 BSC			0.150 BSC		
H	2.667	2.718	2.769	0.1050	0.1070	0.1090
J	0.584 BSC			0.0230 BSC		
K	20.422	20.549	20.676	0.804	0.809	0.814
L	11.28 REF			0.444 REF		
M	0°	---	7°	0°	---	7°
N	4.57 REF			0.180 REF		
P	2.259	2.386	2.513	0.0889	0.0939	0.0989
Q	3.480 BSC			0.1370 BSC		
R	2.54 REF			0.100 REF		
S	0°	---	8°	0°	---	8°
U	6.17 REF			0.243 REF		
W	0°	---	6°	0°	---	6°
Y	2.388 BSC			0.0940 BSC		

STYLE 1:  
PIN 1. BASE  
2. EMITTER  
3. COLLECTOR  
4. ANODE  
5. CATHODE

### GENERIC MARKING DIAGRAM\*

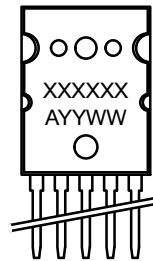

XXXXXX = Specific Device Code  
A = Assembly Location  
YY = Year  
WW = Work Week  
G or ■ = Pb-Free Package

\*This information is generic. Please refer to device data sheet for actual part marking. Pb-Free indicator, "G" or microdot "■", may or may not be present.

DOCUMENT NUMBER:	98AON19871D	Electronic versions are uncontrolled except when accessed directly from the Document Repository. Printed versions are uncontrolled except when stamped "CONTROLLED COPY" in red.
DESCRIPTION:	TO-264, 5 LEAD	PAGE 1 OF 1

ON Semiconductor and are trademarks of Semiconductor Components Industries, LLC dba ON Semiconductor or its subsidiaries in the United States and/or other countries. ON Semiconductor reserves the right to make changes without further notice to any products herein. ON Semiconductor makes no warranty, representation or guarantee regarding the suitability of its products for any particular purpose, nor does ON Semiconductor assume any liability arising out of the application or use of any product or circuit, and specifically disclaims any and all liability, including without limitation special, consequential or incidental damages. ON Semiconductor does not convey any license under its patent rights nor the rights of others.

ON Semiconductor and  are trademarks of Semiconductor Components Industries, LLC dba ON Semiconductor or its subsidiaries in the United States and/or other countries. ON Semiconductor owns the rights to a number of patents, trademarks, copyrights, trade secrets, and other intellectual property. A listing of ON Semiconductor's product/patent coverage may be accessed at [www.onsemi.com/site/pdf/Patent-Marking.pdf](http://www.onsemi.com/site/pdf/Patent-Marking.pdf). ON Semiconductor reserves the right to make changes without further notice to any products herein. ON Semiconductor makes no warranty, representation or guarantee regarding the suitability of its products for any particular purpose, nor does ON Semiconductor assume any liability arising out of the application or use of any product or circuit, and specifically disclaims any and all liability, including without limitation special, consequential or incidental damages. Buyer is responsible for its products and applications using ON Semiconductor products, including compliance with all laws, regulations and safety requirements or standards, regardless of any support or applications information provided by ON Semiconductor. "Typical" parameters which may be provided in ON Semiconductor data sheets and/or specifications can and do vary in different applications and actual performance may vary over time. All operating parameters, including "Typicals" must be validated for each customer application by customer's technical experts. ON Semiconductor does not convey any license under its patent rights nor the rights of others. ON Semiconductor products are not designed, intended, or authorized for use as a critical component in life support systems or any FDA Class 3 medical devices or medical devices with a same or similar classification in a foreign jurisdiction or any devices intended for implantation in the human body. Should Buyer purchase or use ON Semiconductor products for any such unintended or unauthorized application, Buyer shall indemnify and hold ON Semiconductor and its officers, employees, subsidiaries, affiliates, and distributors harmless against all claims, costs, damages, and expenses, and reasonable attorney fees arising out of, directly or indirectly, any claim of personal injury or death associated with such unintended or unauthorized use, even if such claim alleges that ON Semiconductor was negligent regarding the design or manufacture of the part. ON Semiconductor is an Equal Opportunity/Affirmative Action Employer. This literature is subject to all applicable copyright laws and is not for resale in any manner.

## PUBLICATION ORDERING INFORMATION

### LITERATURE FULFILLMENT:

Email Requests to: [orderlit@onsemi.com](mailto:orderlit@onsemi.com)

ON Semiconductor Website: [www.onsemi.com](http://www.onsemi.com)

### TECHNICAL SUPPORT

North American Technical Support:  
Voice Mail: 1 800-282-9855 Toll Free USA/Canada  
Phone: 011 421 33 790 2910

### Europe, Middle East and Africa Technical Support:

Phone: 00421 33 790 2910

For additional information, please contact your local Sales Representative