

The logo for DONE, featuring the word "DONE" in a bold, teal, sans-serif font. The letter "D" is stylized with a white circular element on its left side. The logo is contained within a white rounded square with a thin teal border.

MXG SERIES LED DRIVERS

DL-240W-A/P/X-MXG SPEC

V1.2

Features

- Class I structure
- Input voltage: 120-277 V ~ 50/60 Hz
- Efficiency :94%(Typ.)
- Constant power drive and constant current output control mode
- Metal shell structure, protection grade: IP67
- Lightning protection level: differential mode 6kV, common mode 15kV
- Function selection:
 - Output current is adjusted by external potentiometer (A version only)
 - Input over-voltage protection (only P version optional)
 - Isolated 3 in 1 dimming (X/P version only)
 - Auxiliary source: 12V/300mA (X version only)
- Lifetime design: 5 years



Applications

Road lighting、Industrial lighting、Venue lighting
 Floodlight lighting、Landscape lighting、Plant lighting



Model list

Model NO.	Input voltage	Output power	Output voltage	The default current	Eff.	T.H.D	PF
DL-240W-V56A-MXG DL-240W-V56P-MXG DL-240W-V56X-MXG	120-277V 50/60Hz	240W	25-56Vdc	6.0A	≥92%	≤10%	≥0.95
DL-240W-V343A-MXG DL-240W-V343P-MXG DL-240W-V343X-MXG	120-277V 50/60Hz	240W	171-343Vdc	0.7A	≥94%	≤10%	≥0.95

- Note :**
1. Test conditions of the above parameters: Ta=25℃, 230Vac input, full load operation for 30 minutes;
 2. When the input is less than 108Vac±10%, the output power gradually decreases. When the input 120-277Vac, rated power 240W. Please refer to “THE OUTPUT POWER VS INPUT VOLTAGE” curve chart for details.
 - 3.P version can be equipped with input over-voltage protection function.

Input characteristics

Parameter	Min	Typ.	Max	Note
Rated input voltage	120Vac 150Vdc	230Vac	277Vac 420Vdc	
Input voltage range	108Vac	-	305Vac	
Rated frequency	47Hz	50/60Hz	63Hz	
Power factor	0.95	-	-	@230Vac full load, rated input voltage
Power factor	0.9	-	-	65%-100% load, 100-277VAC input
T.H.D.	-	-	10%	@230Vac full load
T.H.D.	-	-	20%	65%-100% load, 120-277VAC input
Input current	-	-	3.0A	@120Vac full load
Inrush current	-	-	100A	230Vac, cold start (25°C)

Output characteristic

Parameter	Min	Typ.	Max	Note
Rated current	-	4.29A	-	
DL-240W-V56A/P/X-MXG	-	0.7A	-	
DL-240W-V343A/P/X-MXG	-	-	-	
Output current range	3.5A	-	6.7A	
DL-240W-V56A/P/X-MXG	0.5A	-	1.05A	
DL-240W-V343A/P/X-MXG	-	-	-	
Output voltage range	25V	-	56V	
DL-240W-V56A/P/X-MXG	171V	-	343V	
DL-240W-V343A/P/X-MXG	-	-	-	
Rated power(90-120Vac)	-	120W	240W	The derating begins when the input voltage is less than 108Vac ±10%
Rated power(120-277Vac)	-	240W	-	
No-load voltage	-	-	75V	
DL-240W-V56A/P/X-MXG	-	-	400V	
DL-240W-V343A/P/X-MXG	-	-	-	
Efficiency@120Vac	88%	90%	-	full load @120Vac
DL-240W-V56A/P/X-MXG	89%	91%	-	
DL-240W-V343A/P/X-MXG	-	-	-	

Output characteristic

Parameter	Min	Typ.	Max	Note
Efficiency@230Vac DL-240W-V56A/P/X-MXG DL-240W-V343A/P/X-MXG	91% 92%	93% 94%	-	full load @230Vac
Output Current Ripple	-	5% I _{omax}	-	100% load , 20 MHz BW ; Ripple =rms/ average
Accuracy of output current	-5%	-	+5%	full load
Line regulation	-3%	-	+3%	full load
Load regulation	-3%	-	+3%	full load
Starting time	300 ms	-	1000 ms	Full load@120-277Vac
12V output line voltage	10.8V	12V	13.2V	-
12V output line current	0 mA	-	300 mA	Reference ground is "Dim -"
12V output line transient peak current @6W	-	-	500 mA	In a 5.0ms cycle, the maximum duration of the maximum peak current of 500mA is 2ms, and the average value must not exceed 250mA

Note: The output current range is limited by the input and output voltage, please refer to "I-V WORKING AREA" for details.

Dimming characteristic

Dimming function		Min	Typ.	Max	Instructions
0-10V Dimming (Optional)	Safe applied voltage range	0V	-	12V	When the external voltage is $\geq 12V$, the dimming will fail
	Dimming output range	0%	-	100%	-
	Rated dimming voltage range	0V	-	10V	It can be set to negative dimming mode through program setting
PWM Dimming (Optional)	PWM high level	9.5V	-	10.5V	-
	PWM low level	0	-	0.3V	-
	PWM frequency band	300Hz	-	2000Hz	-
	PWM duty cycle	0%	-	100%	Output full power at 99% duty cycle
Resistor Dimming (Optional)	External resistance value	0K Ω	-	100K Ω	-
	Dimming output range	0%	-	100%	-
Multiple time-controlled dimming (optional)	MCU control	Set segment dimming function through program			Working mode
	Timer control	It is divided into six segments by default and can be customized			24H to achieve a cycle

Note:

1. Output current of dimming port: 100uA (typical value);
2. The X version is 0-10V dimming, and the P version is 1-10V dimming (0V can be turned off). The maximum voltage of the dimming port is 12V. If the external power supply voltage exceeds 12V or the signal cable is inverted, the power supply will be damaged;
3. Dimming default setting is three in one positive logic dimming (programmable software can be set to timing dimming, 0-5V or other voltage dimming);
4. When set to positive logic dimming function, the 0V dimming is turned off, and the output voltage is $0.46 \cdot V_{omax}$ after the dimming is turned off. Be careful when using this function, but customers are advised to use 1-10V dimming.
5. When setting negative logic dimming, the default output is 100% when the dimming is suspended. Negative logic dimming cannot be turned off. When the port voltage of the dimming is greater than 10.5V, the maximum power output of the power supply will be achieved.

Protection

Function		Function instructions			
Input over-voltage protection (only P version optional)	Input over-voltage protection	Min.	Typ.	Max.	Notes
		320 Vac	340 Vac	350 Vac	Turn off the output when the input voltage exceeds protection voltage.
	Input over-voltage recovery	Min.	Typ.	Max.	Notes
		300 Vac	320 Vac	340 Vac	The driver will restart automatically when the input voltage falls below recovery voltage.
Input under-voltage protection		When the input voltage is less than 108Vac $\pm 10\%$, the output power gradually decreases.			
Output overload protection		Protection mode:hiccup mode,recovers automatically after fault condition is removed.			
Output short circuit protection		Hiccup mode:recovers automatically after fault condition is removed			
Over temperature protection		Self-recovery type: when the housing temperature is greater than 90°C, the output power decreases gradually.			
Output over-voltage protection		Protection mode: Hiccup mode or clamped in output highest voltage, the product is not damaged. LED driver works normally after fault condition is removed.			

Note:

1. Unless otherwise specified, all specifications and parameters shall be measured at the conditions of 230Vac (50Hz), rated load and 25°C of ambient temperature;
2. Including setting error, line regulation and load regulation.

Environmental

Environmental categories	Parameter
Working temperature	-40 ~ +55°C @200-277Vac, -40 ~ +45°C @120-200Vac (refer to "Life Curve ")
Max.Case Temp.	-40 ~ 90°C
Working humidity	20 ~ 95% RH, non condensing
Storage temperature, humidity	-40 ~ +80°C, 10 ~ 95% RH
Resistant to vibration	10 ~ 500Hz, 5G 12 min/cycle, X, Y, Z axis 72 min each
MTBF	230Khrs min. MIL-HDBK-217F (Ta=25°C)
Lifetime	75,000 hours @Tcase≤75°C,230Vac, 80% Load, Please refer to "Tcase VS Lifetime" section

Safety and EMC

Safety categories	Standard
Safety	GB19510.1、GB19510.14、EN61347-1、EN61347-2-13、IEC61347-1、IEC61347-2-13、AS/NZS61347.1、AS61347.2.13、EN 62384、UL8750;
EMC	EN 55015、EN 61000-3-2 、GB/T 17743、GB17625.1、EN 61000-3-3
Surge protection	Differential mode L-N $\pm 6KV$ (2 ohm), common mode L, N-PE $\pm 15 KV$ (12 ohm); Refer to IEC61000-4-5 2014 Criterion B
High-pot test	I/P-O/P:3.75KVac I/P-PE :1.5KVac O/P-PE : 0.5KVac I/P-DIM:3.75KVac O/P-DIM:1.5KVac
Insulation impedance	I/P-PE:100M Ω / 500VDC; I/P-O/P:100M Ω / 500VDC / 25 $^{\circ}C$ / 70% RH
Leakage current	<0.7mA@277Vac

Note:

The driver is considered as a component that will be operated in combination with the final equipment. Since EMC performance will be affected by the complete installation, the final equipment manufacturers must re-qualify EMC Directive on the complete installation again.

I-V Working Area

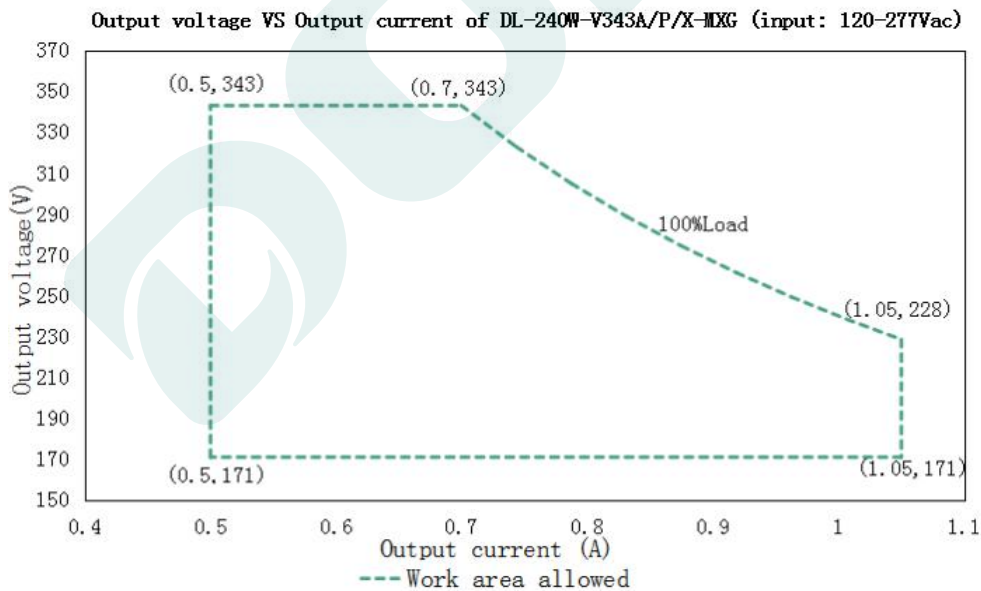

Load	Output								
Load working Voltage	171V	190V	205V	228V	251V	274V	297V	320V	343V
Io_MAX	1.05A	1.05A	1.05A	1.05A	0.96A	0.88A	0.81A	0.75A	0.7A
Po_MAX	167.5W	187.6W	214.4W	240W	241W	241.1W	240.6W	240W	240.1W

Output voltage VS Output current of DL-240W-V56A/P/X-MXG (input: 120-277Vac)

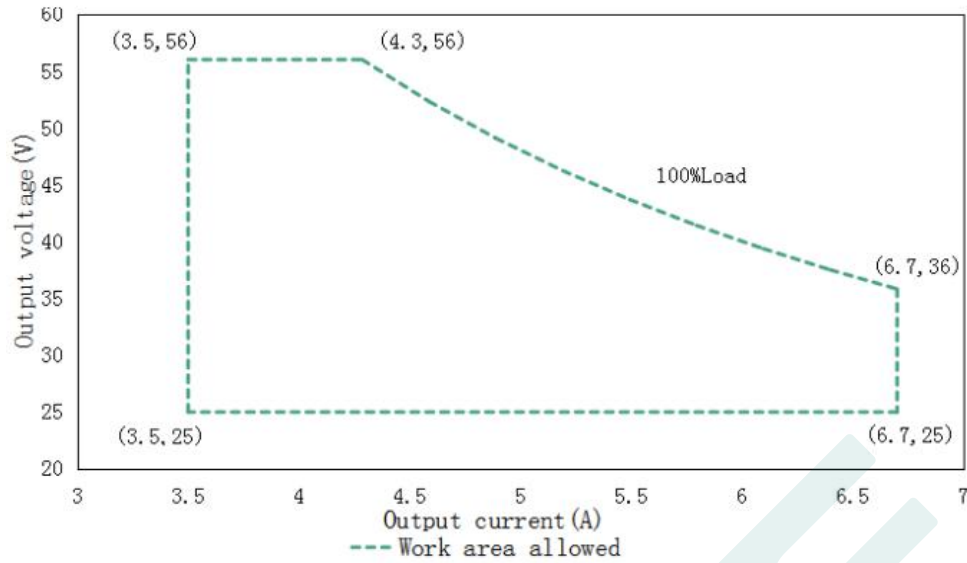

Load	Output									
	25V	29V	33V	36V	40V	44V	48V	52V	56V	
Load working Voltage	25V	29V	33V	36V	40V	44V	48V	52V	56V	
Io_MAX	6.67A	6.67A	6.67A	6.67A	6A	5.45A	5A	4.62A	4.29A	
Po_MAX	166.75W	193.43W	220.11W	240W	240W	240W	240W	240W	240W	

Eff. VS Output voltage(DL-240W-V343A/P/X-MXG)

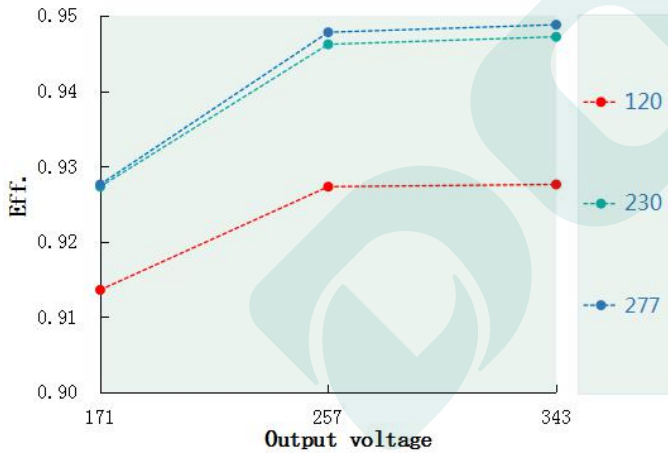

Eff. VS Output voltage(DL-240W-V56A/P/X-MXG)

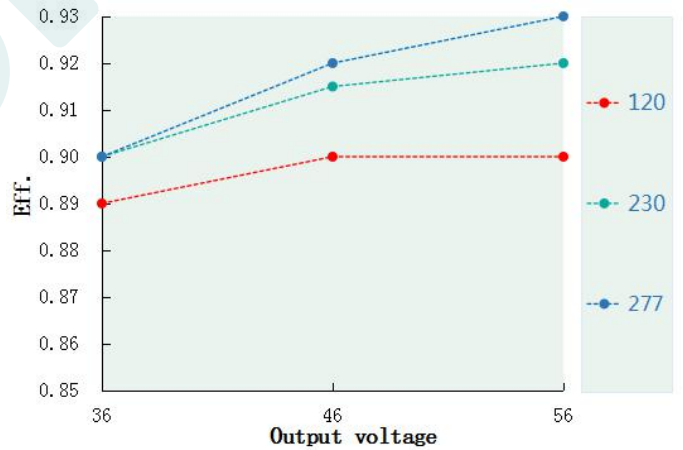

Power factor VS Input voltage(DL-240W-V343A/P/X-MXG)

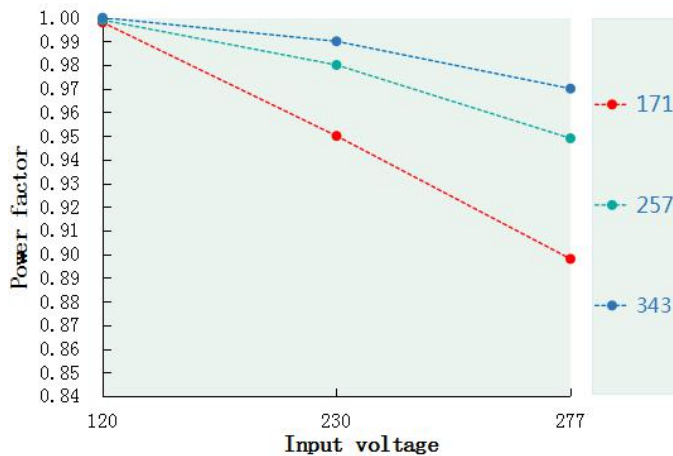

Power factor VS Input voltage(DL-240W-V56A/P/X-MXG)

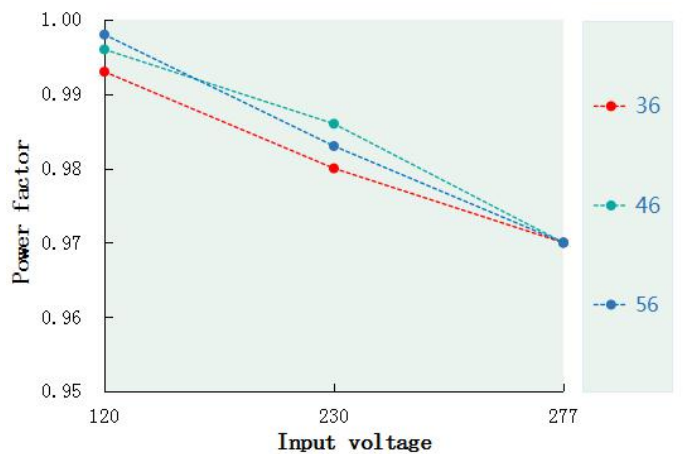

T.H.D. VS Output voltage(DL-240W-V343A/P/X-MXG)

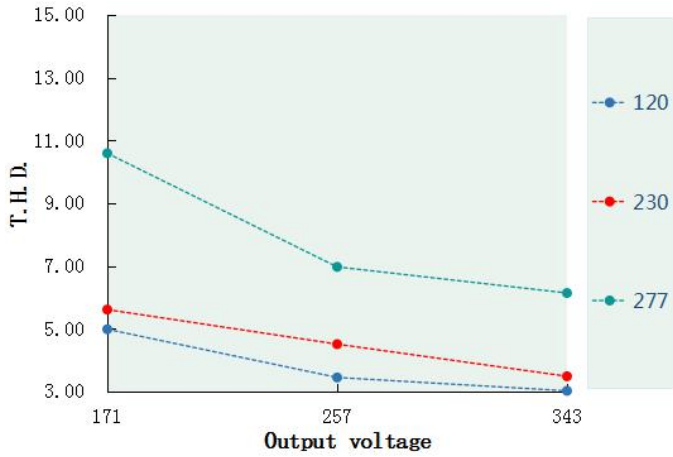

T.H.D. VS Output voltage(DL-240W-V56A/P/X-MXG)

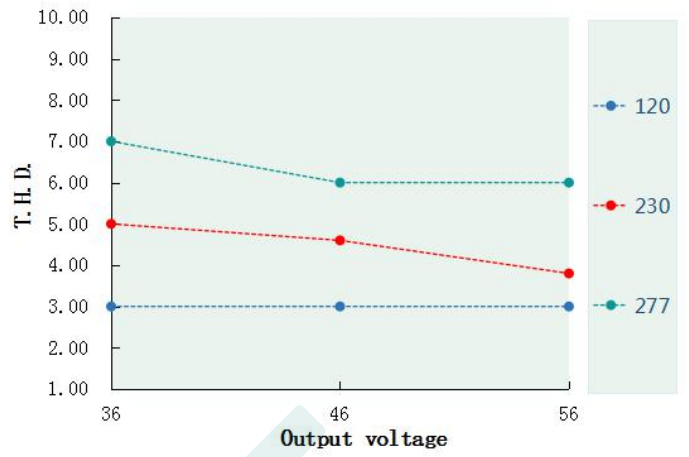

Tcase VS Lifetime(DL-240W-A/P/X-MXG)

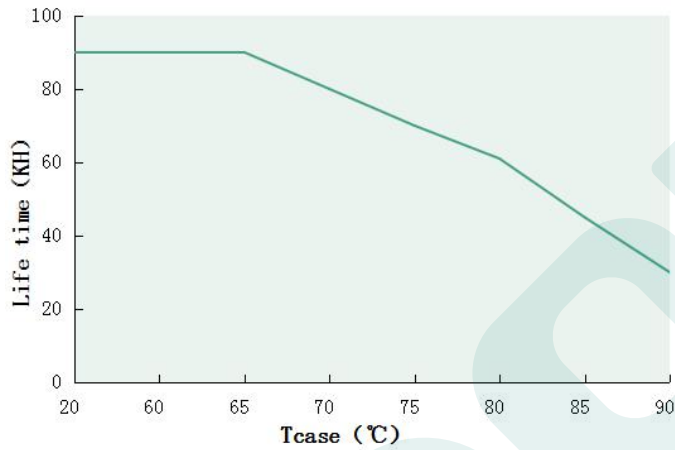

Output power VS Tcase (DL-240W-A/P/X-MXG)

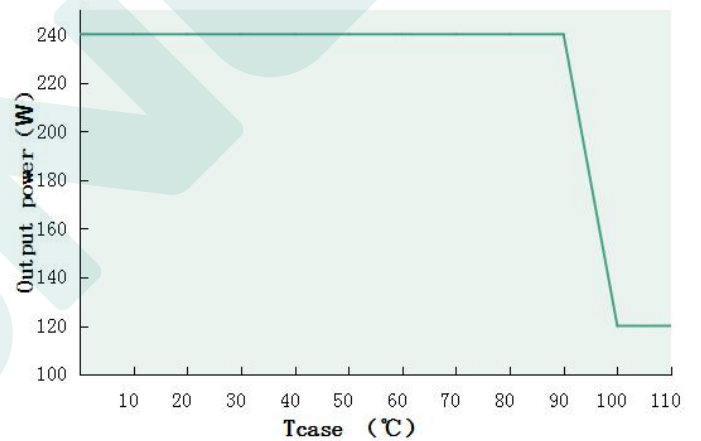

Inrush Current (DL-240W-A/P/X-MXG)

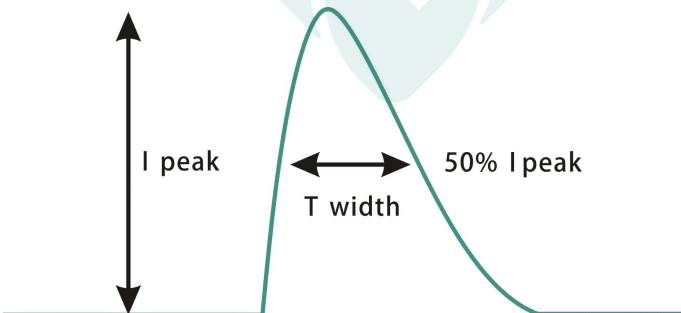

Input voltage	Peak current	T(@50% Peak current)
120Vac	78A	362us
230Vac	96.4A	362us
277Vac	107A	376us

Output power VS Input voltage

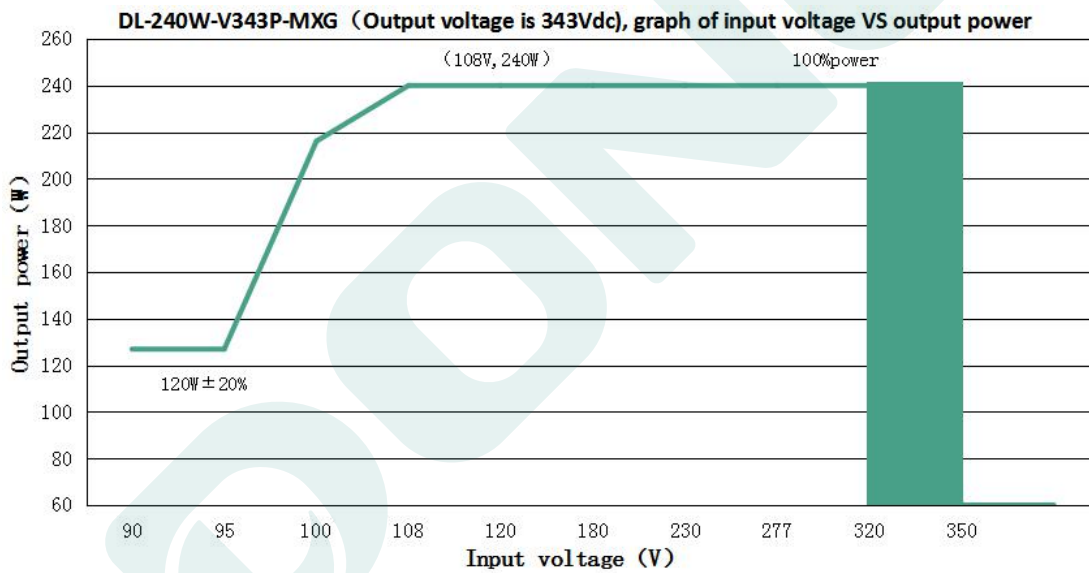
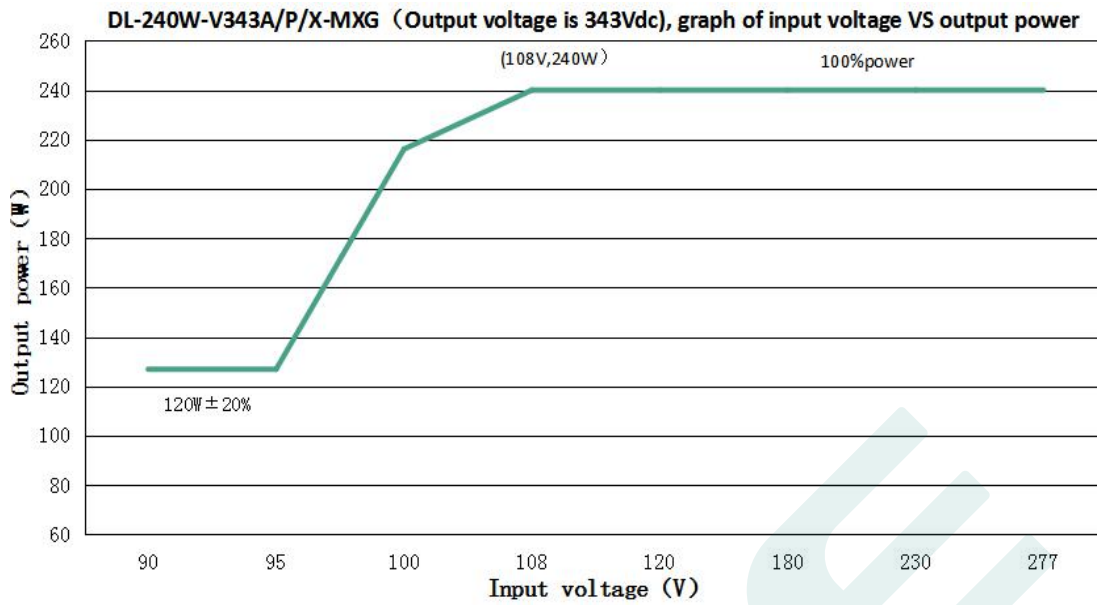

DL-240W-V343A/P/X-MXG (When the output voltage is 343Vdc, the rated output current value and output power corresponding to different input voltage)

Input Voltage	90Vac	95Vac	100Vac	108Vac	120Vac	180Vac	230Vac	277Vac
Iout	0.37A	0.37A	0.63A	0.7A	0.7A	0.7A	0.7A	0.7A
Pout	126.9W	126.9W	216.1W	240W	240W	240W	240W	240W

Note:
 Output power will decrease gradually when input voltage less than 108Vac ± 10%; When the input voltage is 90Vac, the output power range is 120W ± 20%.

Output power versus Input voltage

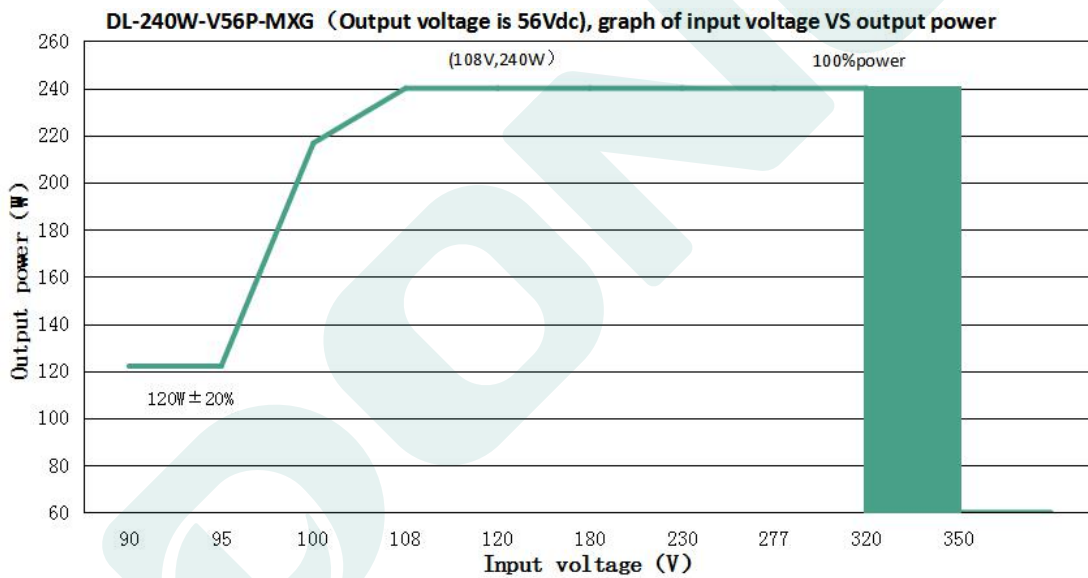
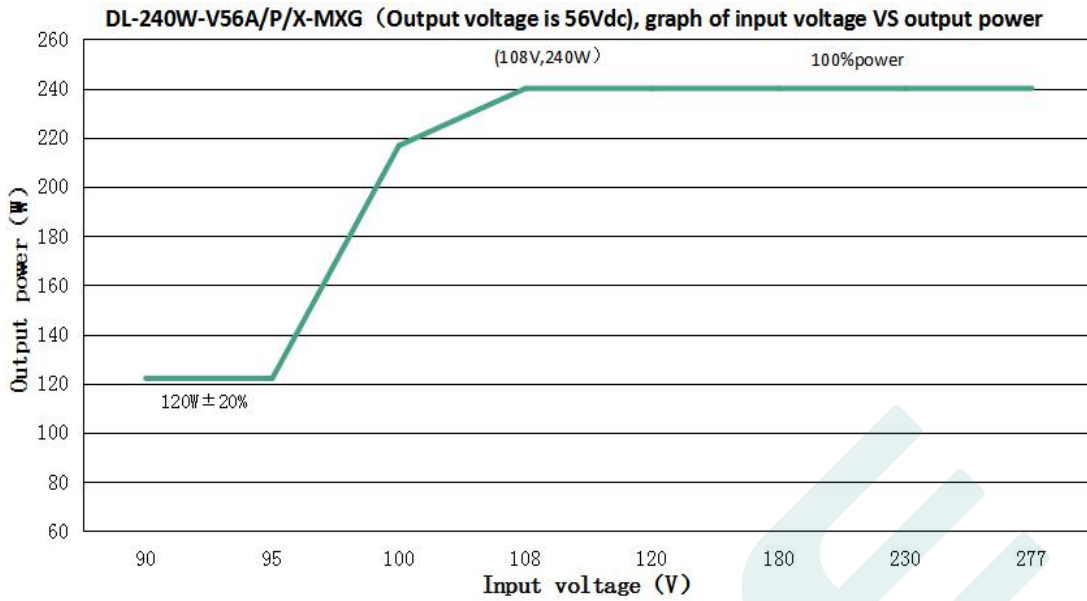

DL-240W-V56A/P/X-MXG (When the output voltage is 56Vdc, the rated output current value and output power corresponding to different input voltage)

Input Voltage	90Vac	95Vac	100Vac	108Vac	120Vac	180Vac	230Vac	277Vac
Iout	2.18A	2.18A	3.87A	4.29A	4.29A	4.29A	4.29A	4.29A
Pout	122.08W	122.08W	216.72W	240W	240W	240W	240W	240W

Note:
 Output power will decrease gradually when input voltage less than 108Vac ± 10%; When the input voltage is 90Vac, the output power range is 120W ± 20%.

Dimming operation

※ Three-in-one dimming function (X version only)

- A. Connect a resistor 0-100K or 0-10V DC voltage or 10V PWM signal between DIM+ and DIM- to adjust the output current.
- B. Output current of dimming port: 100uA (typical value).

◎ With an applied voltage of 0-10V:

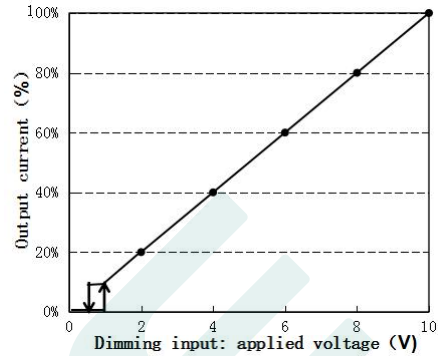
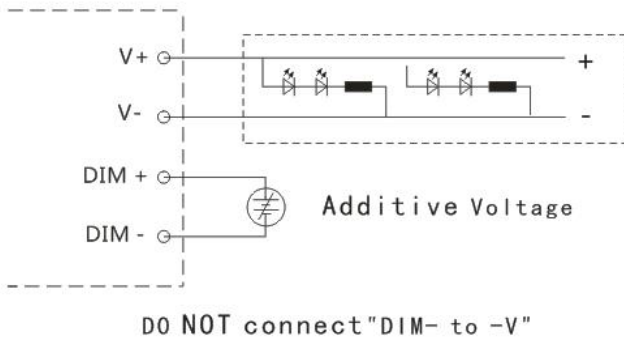

◎ Applying additive 10V PWM signal (Frequency range: 300Hz-2K Hz) :

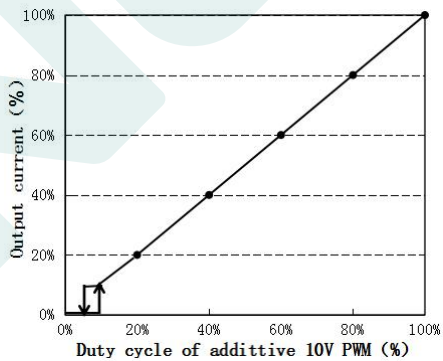
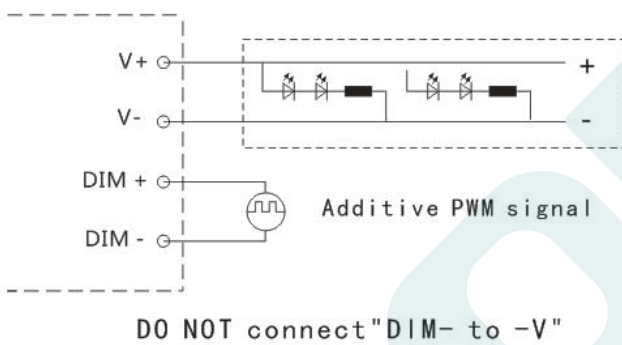

◎ With an additional 0-100K resistor:

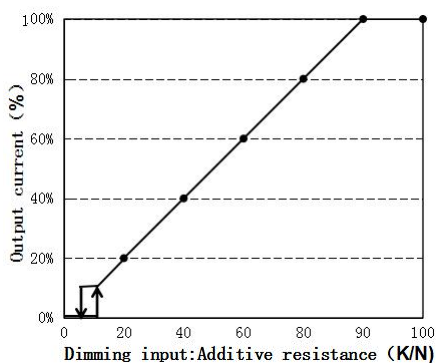
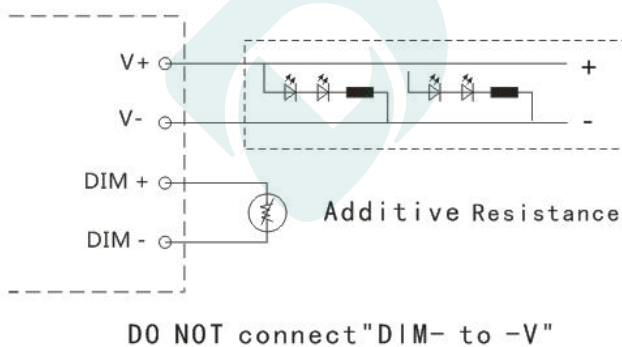

Note:

1. Positive and negative logic dimming can be programmed.
2. Dimming off only applies to positive logic. For other requirements, please contact technical personnel.

Mechanical specification

Size (mm) L217*W63*H37

DL-240W-V56A-MXG DL-240W-V343A-MXG

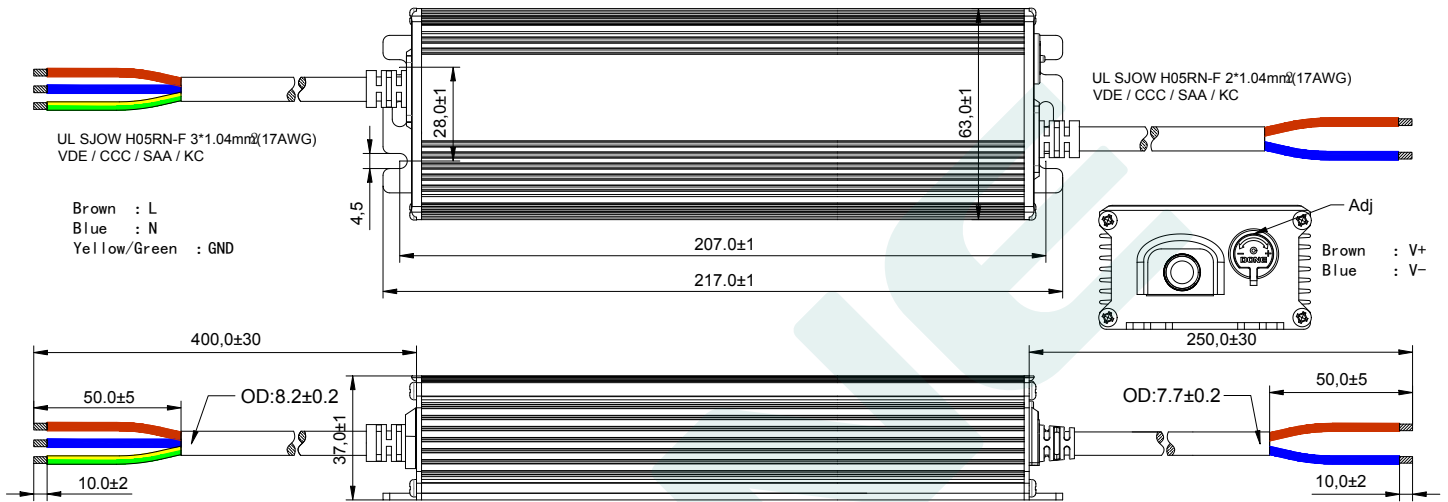

DL-240W-V56P-MXG DL-240W-V343P-MXG

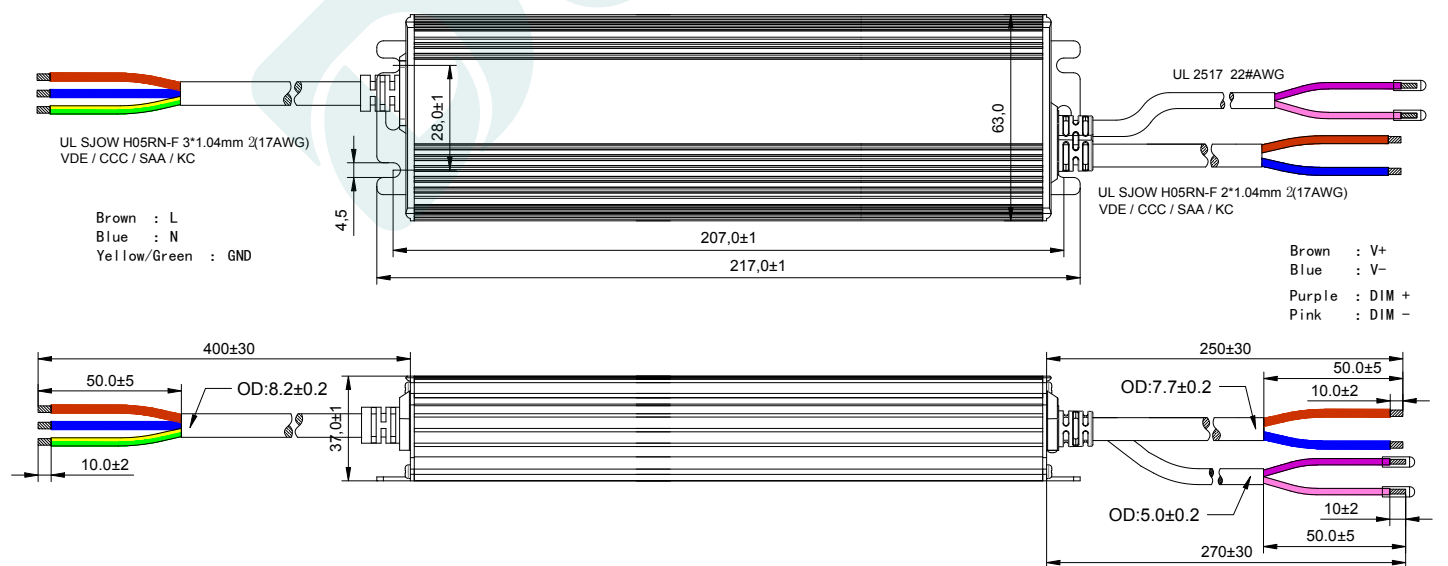

DL-240W-V56X-MXG
DL-240W-V343X-MXG

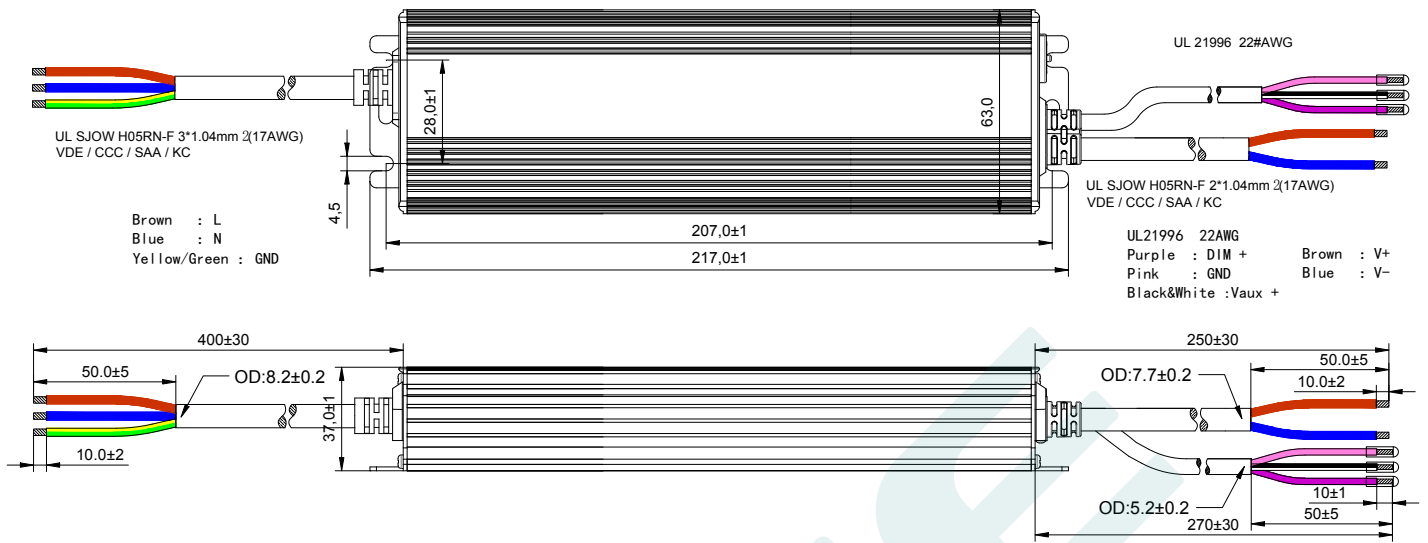

Weight

Weight	1000 g
--------	--------

Packaging

Packaging (mm) L475*W350*H160

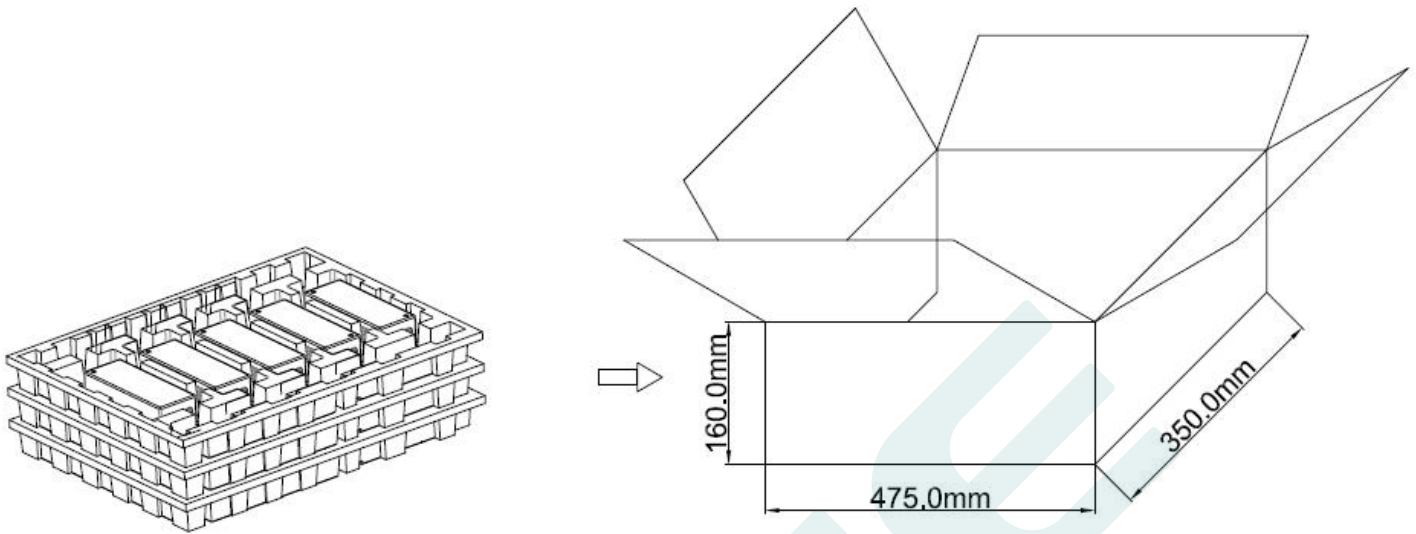

Note: One Carton 3 layers and 5 pcs each layer, total 15pcs/carton.

Note:

1. According to the certificate obtained by the LED DRIVER, the LED DRIVER with the English label is sold in Europe, America and India.
2. The LED DRIVER with Chinese label is only used for China market.

Version

DATE	DESCRIPTION	REV.	CHECK
2022.4.11	Initial version.	V1.0	
2022.10.15	Update wire and efficiency description.	V1.1	
2022.12.24	Add P version optional input over-voltage protection.	V1.2	

MANUFACTURER

EDIT	CHECK	APPROVE