

TINA2-RS

~14° spot beam. Assembly with holder, installation tape and location pins.

TECHNICAL SPECIFICATIONS:

Dimensions	Ø 16.0 mm
Height	9.5 mm
Fastening	tape, pin
Colour	black
Box size	451 x 241 x 298 mm
Box weight	8.3 kg
Quantity in Box	4140 pcs
ROHS compliant	yes ⓘ



MATERIAL SPECIFICATIONS:

Component	Type	Material	Colour
TINA2-RS	Single lens	PMMA	clear
TINA2-HLD-BLK	Holder	PC	black
TINA-TAPE3	Tape	PU tape	black

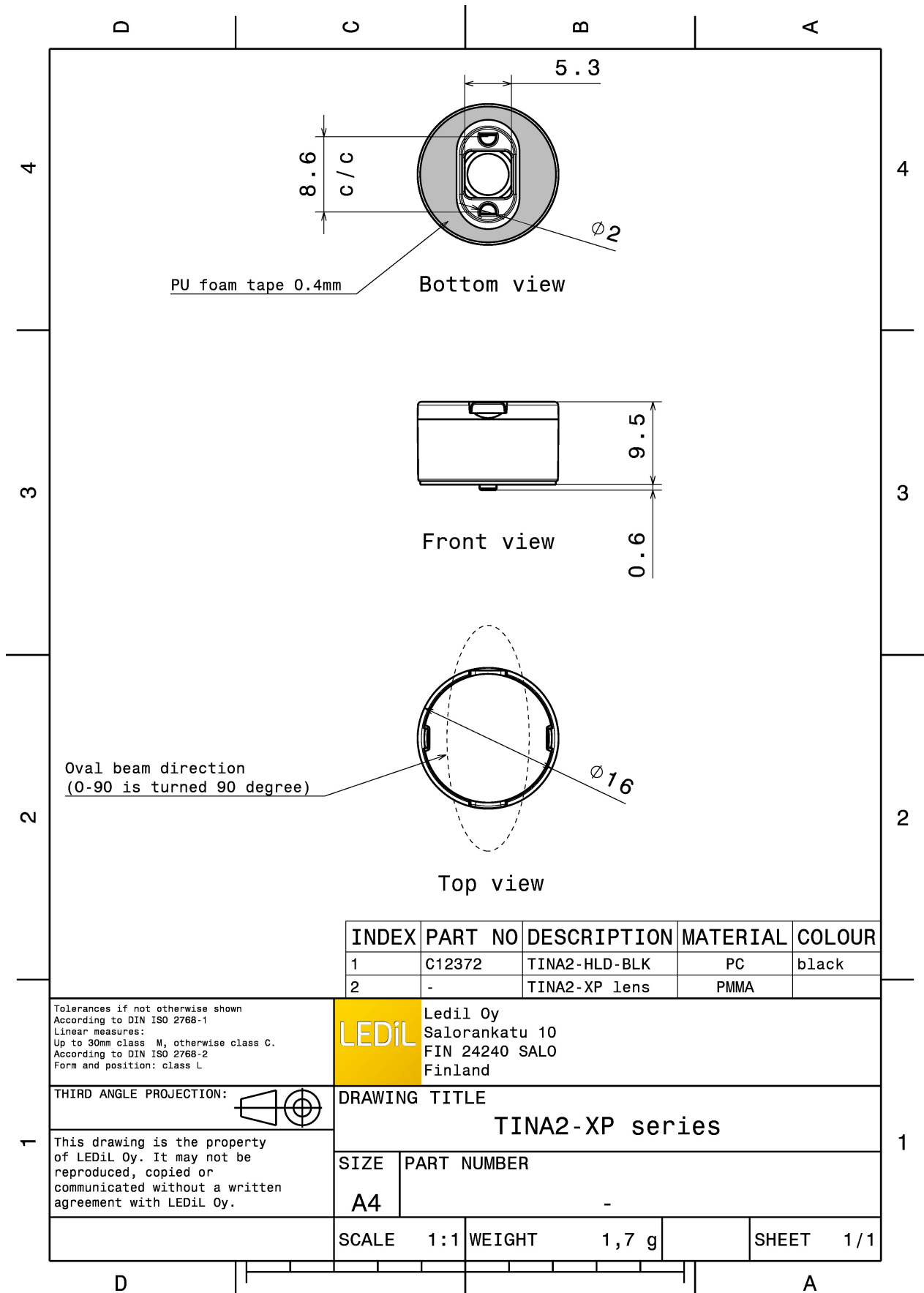

PHOTOMETRIC DATA (MEASURED):



LED XB-H
 FWHM 17.0°
 Efficiency 86 %
 Peak intensity 8.700 cd/lm
 LEDs/each optic 1
 Light colour White
 Required components:

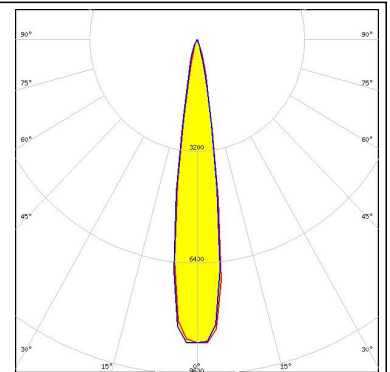

LED XQ-E HI
 FWHM 9.0°
 Efficiency 81 %
 Peak intensity 25.000 cd/lm
 LEDs/each optic 1
 Light colour White
 Required components:

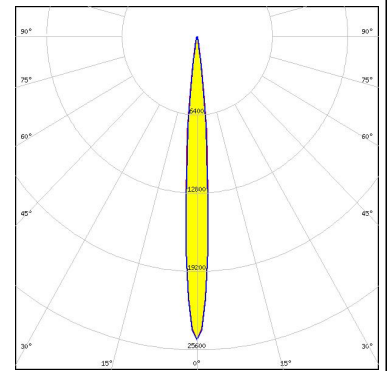

LED LUXEON 5050
 FWHM 25.0°
 Efficiency 88 %
 Peak intensity 2.700 cd/lm
 LEDs/each optic 1
 Light colour White
 Required components:

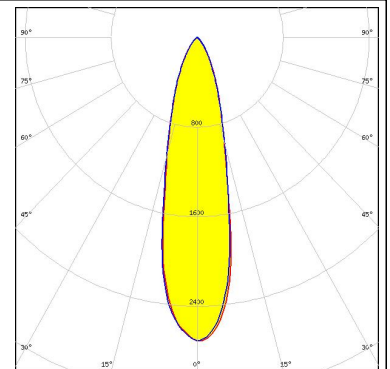
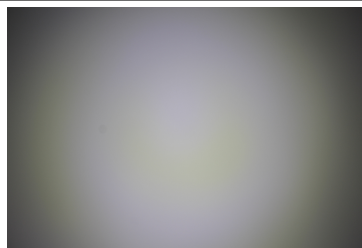

LED LUXEON TX
 FWHM 15.0°
 Efficiency 89 %
 Peak intensity 9.860 cd/lm
 LEDs/each optic 1
 Light colour White
 Required components:

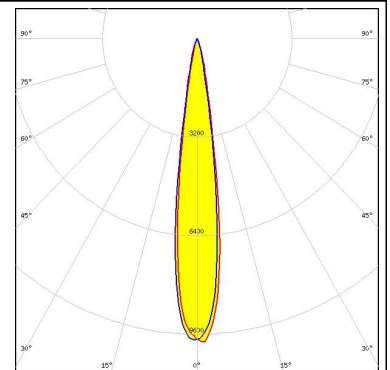

PHOTOMETRIC DATA (MEASURED):



LED NVSxx19B/NVSxx19C
FWHM 18.0°
Efficiency 88 %
Peak intensity 7.000 cd/lm
LEDs/each optic 1
Light colour White
Required components:

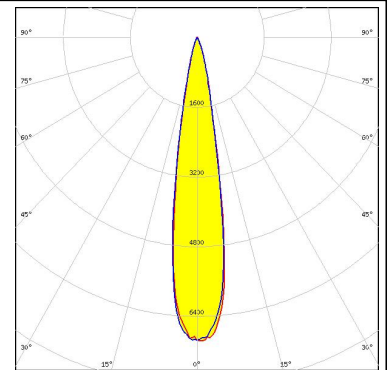

LED NWSx229A
FWHM 25.0°
Efficiency 86 %
Peak intensity 3.600 cd/lm
LEDs/each optic 1
Light colour White
Required components:

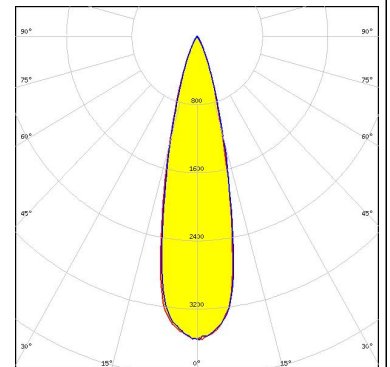
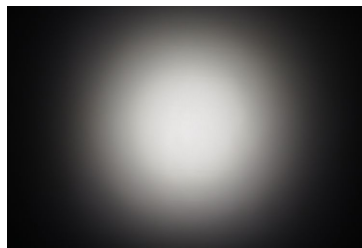

Ospto Semiconductors

LED OSLO Square EC
FWHM 13.0°
Efficiency 88 %
Peak intensity 9.300 cd/lm
LEDs/each optic 1
Light colour White
Required components:



Ospto Semiconductors

LED OSLO Square PC
FWHM 12.0°
Efficiency 88 %
Peak intensity 9.210 cd/lm
LEDs/each optic 1
Light colour White
Required components:

PHOTOMETRIC DATA (MEASURED):

OSRAM

Opto Semiconductors

LED OSLON SSL 150
FWHM 11.0°
Efficiency 90 %
Peak intensity 19.500 cd/lm
LEDs/each optic 1
Light colour White
Required components:

OSRAM

Opto Semiconductors

LED OSLON SSL 80
FWHM 10.0°
Efficiency 88 %
Peak intensity 16.000 cd/lm
LEDs/each optic 1
Light colour White
Required components:

OSRAM

Opto Semiconductors

LED SFH 4715S
FWHM 14.0°
Efficiency %
Peak intensity cd/lm
LEDs/each optic 1
Light colour White
Required components:

OSRAM

Opto Semiconductors

LED SFH 4716S
FWHM 11.0°
Efficiency %
Peak intensity cd/lm
LEDs/each optic 1
Light colour White
Required components:

PHOTOMETRIC DATA (MEASURED):



PHOTOMETRIC DATA (SIMULATED):

LUMILEDS

LED LUXEON C
 FWHM 11.0°
 Efficiency 92 %
 Peak intensity 14.000 cd/lm
 LEDs/each optic 1
 Light colour White
 Required components:

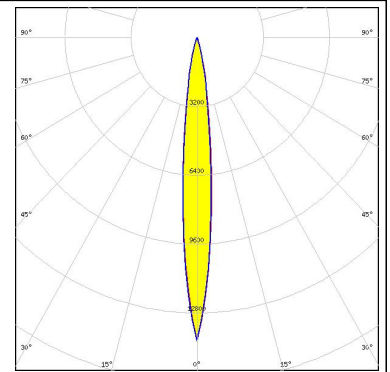

LUMILEDS

LED LUXEON IR Compact
 FWHM 10.0°
 Efficiency 84 %
 Peak intensity 0.000 cd/lm
 LEDs/each optic 1
 Light colour White
 Required components:



NICHIA

LED NFSx757G
 FWHM 10.0°
 Efficiency 93 %
 Peak intensity 16.690 cd/lm
 LEDs/each optic 1
 Light colour White
 Required components:

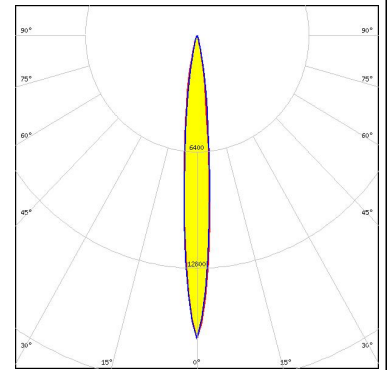

OSRAM

Opto Semiconductors

LED OSOLON Black Flat
 FWHM 8.6°
 Efficiency 92 %
 Peak intensity 32.400 cd/lm
 LEDs/each optic 1
 Light colour White
 Required components:

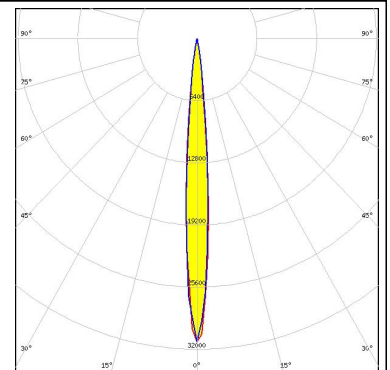

PHOTOMETRIC DATA (SIMULATED):

OSRAM
Opto Semiconductors

LED OSLOM Square Flat
FWHM 11.0°
Efficiency 91 %
Peak intensity 16.400 cd/lm
LEDs/each optic 1
Light colour White
Required components:

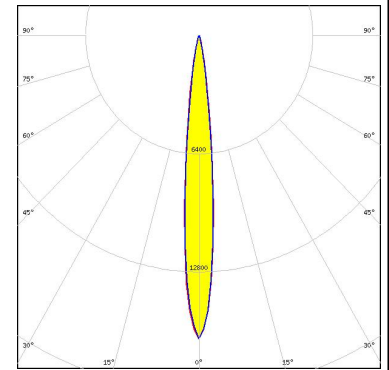

OSRAM
Opto Semiconductors

LED SFH 4770S
FWHM 16.0°
Efficiency 87 %
Peak intensity 9.200 cd/lm
LEDs/each optic 1
Light colour White
Required components:

OSRAM
Opto Semiconductors

LED Synios P2720 1 mm
FWHM 10.0°
Efficiency 92 %
Peak intensity 20.340 cd/lm
LEDs/each optic 1
Light colour White
Required components:

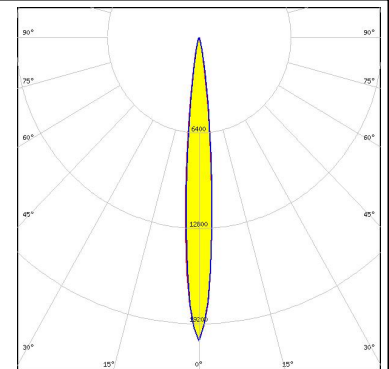

OSRAM
Opto Semiconductors

LED Synios P2720 1/2 mm
FWHM 9.0°
Efficiency 92 %
Peak intensity 24.030 cd/lm
LEDs/each optic 1
Light colour White
Required components:

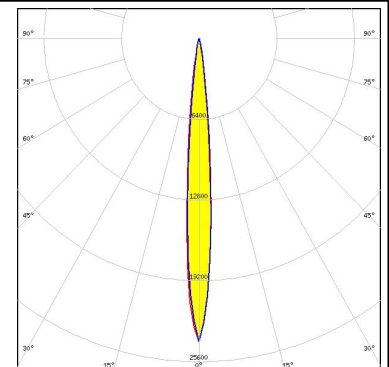

PHOTOMETRIC DATA (SIMULATED):

OSRAM
Opto Semiconductors

LED Synios P2720 1/4 mm
FWHM 8.0°
Efficiency 92 %
Peak intensity 27.470 cd/lm
LEDs/each optic 1
Light colour White
Required components:

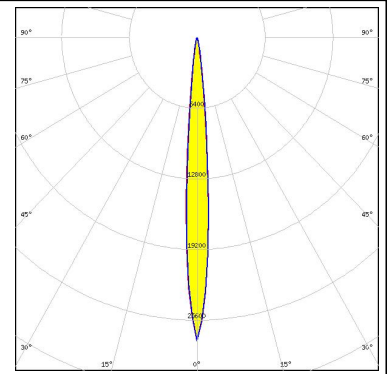

GENERAL INFORMATION:

NOTE: The typical beam angle will be changed by different color, chip size and chip position tolerance. The typical total beam angle is the full angle measured where the luminous intensity is half of the peak value.

MATERIALS:

As part of our continuous research and improvement processes, and to ensure the best possible quality and availability of our products, LEDiL reserves the right to change material grades without notice.

PRODUCT DATA USER AGREEMENT AND DISCLAIMER:

The measured data in the provided downloadable LEDiL Product Datasheets and Mechanical 2D-Drawings is rounded and provided as reference for planning. LEDiL Oy's optical specifications have been verified by conducting performance testing of the products in accordance with the company's quality system. The reported data are averaged results of multiple measurements with typical variation. LEDiL Oy reserves the right to without prior notification make changes and improvements to its products.

LEDiL Oy assumes neither warranty, nor guarantee nor any other liability of any kind for the contents and correctness of the provided data. The provided data has been generated with highest diligence but the provided data may in reality not represent the complete possible variation range of all intrinsic parameters. Therefore, in certain cases a deviation from the provided data could occur.

LEDiL Oy reserves the right to undertake technical changes of its products without further notification which could lead to changes in the provided data. LEDiL Oy assumes no liability of any kind for the possible deviation from any provided data or any other damage resulting from the usage of the provided data.

The user agrees to this disclaimer and user agreement with the download or usage of the provided files.

LEDiL Oy

Joensuunkatu 13
FI-24240 SALO
Finland

LEDiL Inc.

228 West Page Street
Suite D
Sycamore IL 60178
USA

Local sales and technical support

[www.ledil.com/
where_to_buy](http://www.ledil.com/where_to_buy)

Shipping locations

Salo, Finland
Hong Kong, China

Distribution Partners

[www.ledil.com/
where_to_buy](http://www.ledil.com/where_to_buy)