

HEXFET® Power MOSFET

Applications

- High frequency DC-DC converters

V_{DSS}	$R_{DS(on) \text{ max}}$	I_D
80V	$73m\Omega @ V_{GS} = 10V$	3.6A

Benefits

- Low Gate to Drain Charge to Reduce Switching Losses
- Fully Characterized Capacitance Including Effective C_{OSS} to Simplify Design, (See App. Note AN1001)
- Fully Characterized Avalanche Voltage and Current

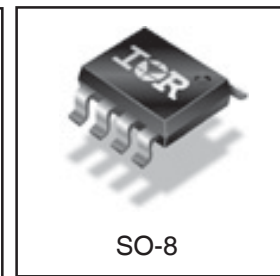
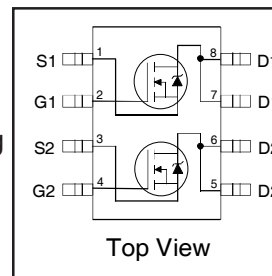

Absolute Maximum Ratings

	Parameter	Max.	Units
V_{DS}	Drain-to-Source Voltage	80	V
V_{GS}	Gate-to-Source Voltage	± 20	
$I_D @ T_A = 25^\circ C$	Continuous Drain Current, $V_{GS} @ 10V$	3.6	A
$I_D @ T_A = 100^\circ C$	Continuous Drain Current, $V_{GS} @ 10V$	2.9	
I_{DM}	Pulsed Drain Current ①	29	
$P_D @ T_A = 25^\circ C$	Maximum Power Dissipation	2.0	W
	Linear Derating Factor	0.02	W/ $^\circ C$
dv/dt	Peak Diode Recovery dv/dt ②	2.3	V/ns
T_J	Operating Junction and	-55 to +150	$^\circ C$
T_{STG}	Storage Temperature Range		

Thermal Resistance

	Parameter	Typ.	Max.	Units
$R_{\theta JL}$	Junction-to-Drain Lead	—	42	$^\circ C/W$
$R_{\theta JA}$	Junction-to-Ambient (PCB Mount) ④	—	62.5	

Notes ① through ④ are on page 8

Static @ T_J = 25°C (unless otherwise specified)

	Parameter	Min.	Typ.	Max.	Units	Conditions
V _{(BR)DSS}	Drain-to-Source Breakdown Voltage	80	—	—	V	V _{GS} = 0V, I _D = 250μA
ΔV _{(BR)DSS} /ΔT _J	Breakdown Voltage Temp. Coefficient	—	0.09	—	V/°C	Reference to 25°C, I _D = 1mA
R _{DS(on)}	Static Drain-to-Source On-Resistance	—	61	73	mΩ	V _{GS} = 10V, I _D = 2.2A ③
V _{GS(th)}	Gate Threshold Voltage	2.0	—	4.0	V	V _{DS} = V _{GS} , I _D = 250μA
I _{DSS}	Drain-to-Source Leakage Current	—	—	20	μA	V _{DS} = 80V, V _{GS} = 0V
		—	—	250		V _{DS} = 64V, V _{GS} = 0V, T _J = 125°C
I _{GSS}	Gate-to-Source Forward Leakage	—	—	200	nA	V _{GS} = 20V
	Gate-to-Source Reverse Leakage	—	—	-200		V _{GS} = -20V

Dynamic @ T_J = 25°C (unless otherwise specified)

	Parameter	Min.	Typ.	Max.	Units	Conditions
g _{fs}	Forward Transconductance	4.3	—	—	S	V _{DS} = 25V, I _D = 2.2A
Q _g	Total Gate Charge	—	15	23	nC	I _D = 2.2A V _{DS} = 40V V _{GS} = 10V ③
Q _{gs}	Gate-to-Source Charge	—	2.9	—		
Q _{gd}	Gate-to-Drain ("Miller") Charge	—	4.5	—		
t _{d(on)}	Turn-On Delay Time	—	9.0	—	ns	V _{DD} = 40V I _D = 2.2A R _G = 24Ω V _{GS} = 10V ③
t _r	Rise Time	—	10	—		
t _{d(off)}	Turn-Off Delay Time	—	41	—		
t _f	Fall Time	—	17	—		
C _{iss}	Input Capacitance	—	660	—	pF	V _{GS} = 0V V _{DS} = 25V f = 1.0MHz V _{GS} = 0V, V _{DS} = 1.0V, f = 1.0MHz V _{GS} = 0V, V _{DS} = 64V, f = 1.0MHz V _{GS} = 0V, V _{DS} = 0V to 64V ③
C _{oss}	Output Capacitance	—	110	—		
C _{rss}	Reverse Transfer Capacitance	—	15	—		
C _{oss}	Output Capacitance	—	710	—		
C _{oss}	Output Capacitance	—	72	—		
C _{oss} eff.	Effective Output Capacitance	—	140	—		

Avalanche Characteristics

	Parameter	Typ.	Max.	Units
E _{AS}	Single Pulse Avalanche Energy ①②	—	75	mJ
I _{AR}	Avalanche Current ①	—	2.2	A

Diode Characteristics

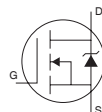
	Parameter	Min.	Typ.	Max.	Units	Conditions
I _S	Continuous Source Current (Body Diode)	—	—	3.6	A	MOSFET symbol showing the integral reverse p-n junction diode. 
I _{SM}	Pulsed Source Current (Body Diode) ①	—	—	29	A	
V _{SD}	Diode Forward Voltage	—	—	1.3	V	T _J = 25°C, I _S = 2.2A, V _{GS} = 0V ③
t _{rr}	Reverse Recovery Time	—	50	—	ns	T _J = 25°C, I _F = 2.2A, V _{DD} = 40V
Q _{rr}	Reverse Recovery Charge	—	110	—	nC	di/dt = 100A/μs ③

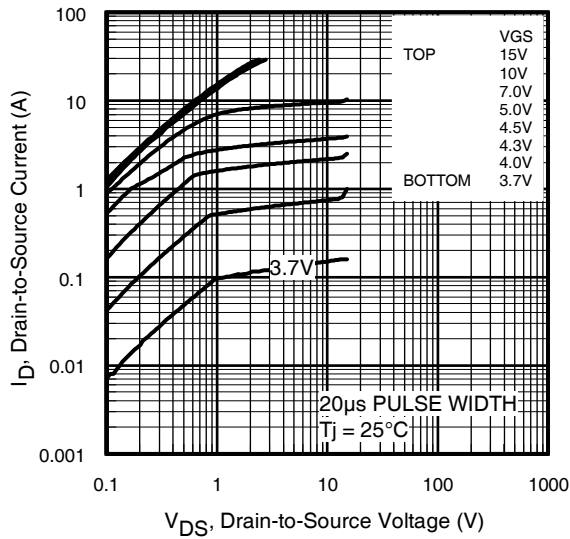
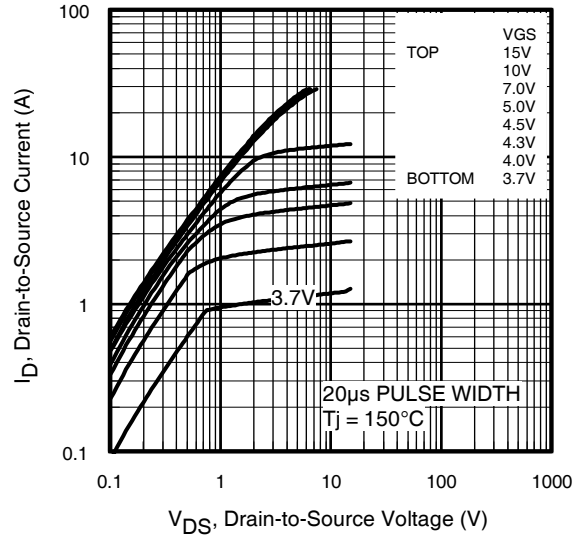
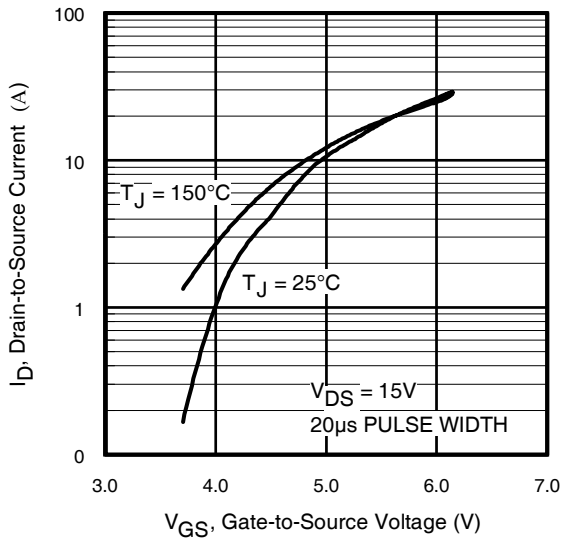
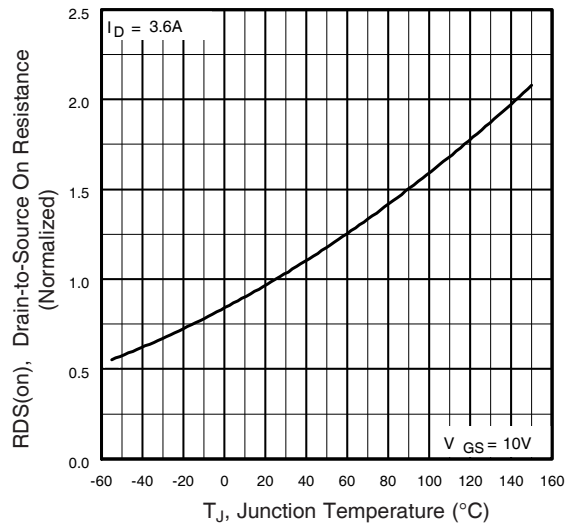
Fig 1. Typical Output Characteristics

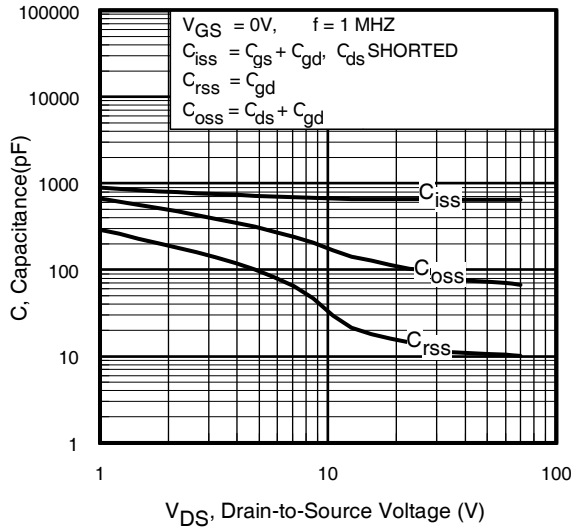
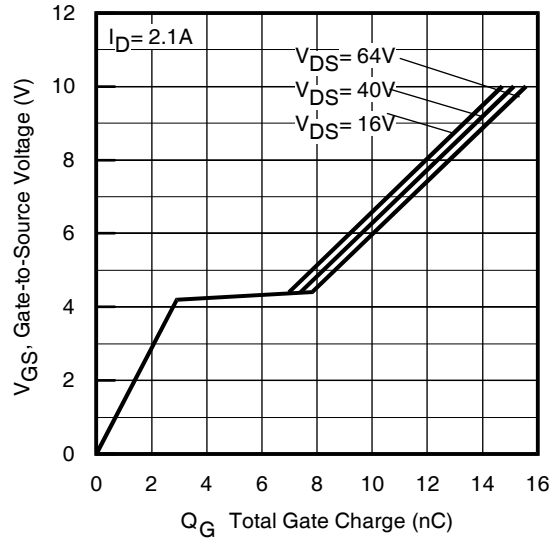
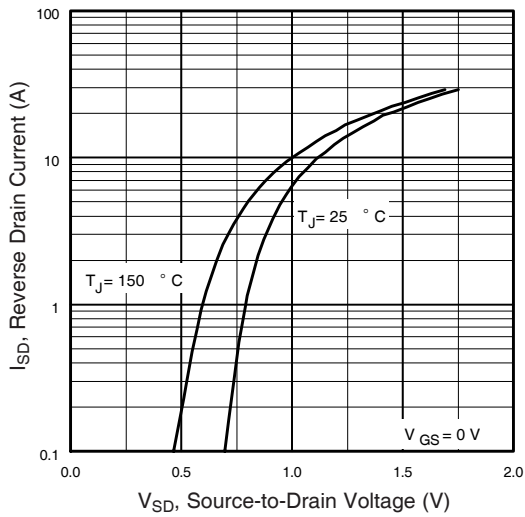
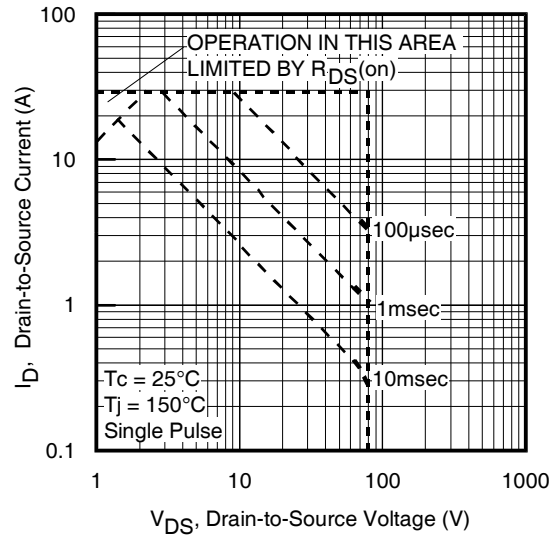
Fig 2. Typical Output Characteristics

Fig 3. Typical Transfer Characteristics

Fig 4. Normalized On-Resistance Vs. Temperature

Fig 5. Typical Capacitance Vs. Drain-to-Source Voltage

Fig 6. Typical Gate Charge Vs. Gate-to-Source Voltage

Fig 7. Typical Source-Drain Diode Forward Voltage

Fig 8. Maximum Safe Operating Area

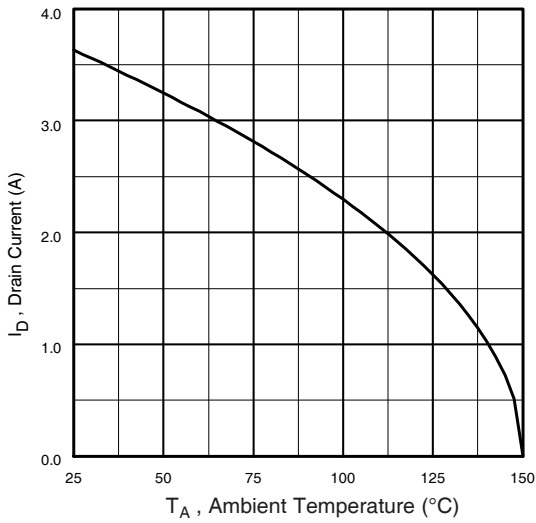

Fig 9. Maximum Drain Current Vs. Ambient Temperature



Fig 10a. Switching Time Test Circuit



Fig 10b. Switching Time Waveforms

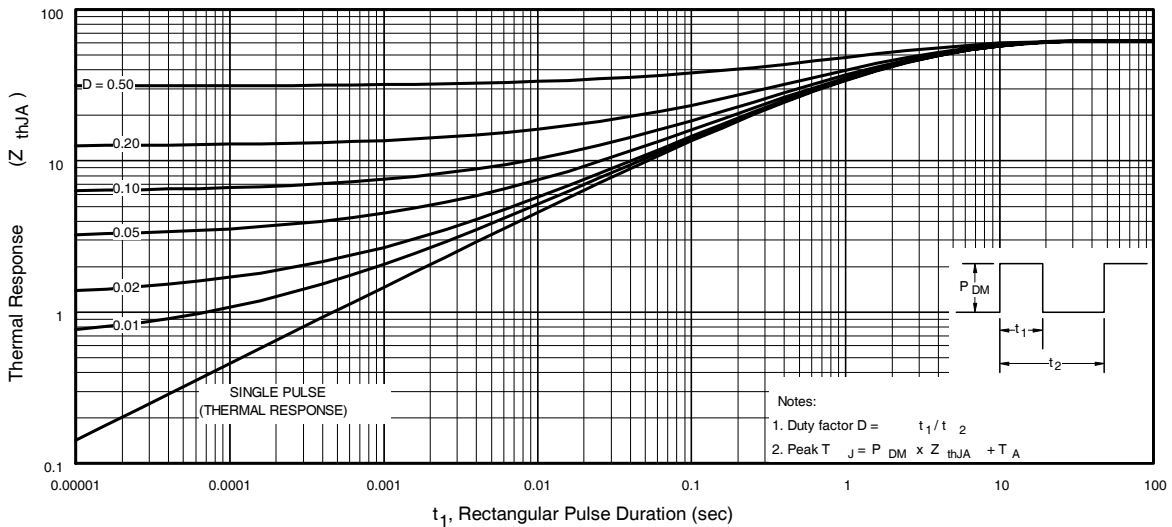
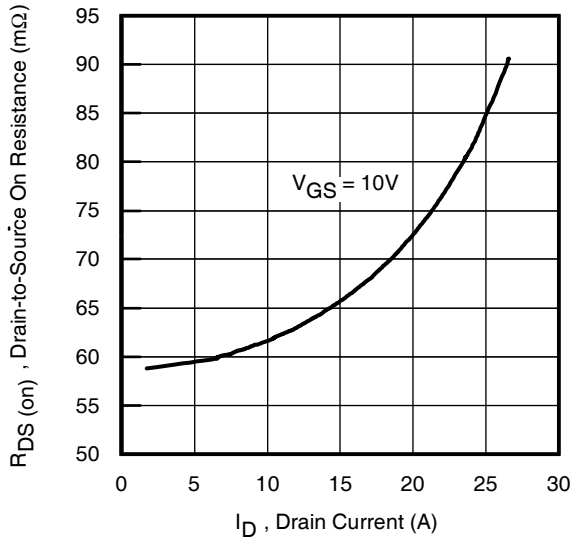
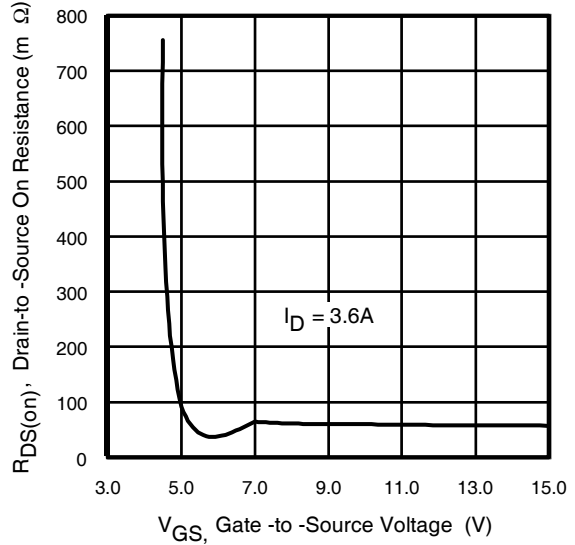
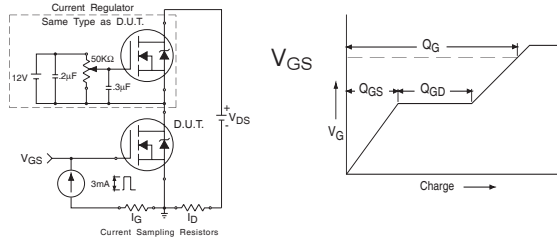
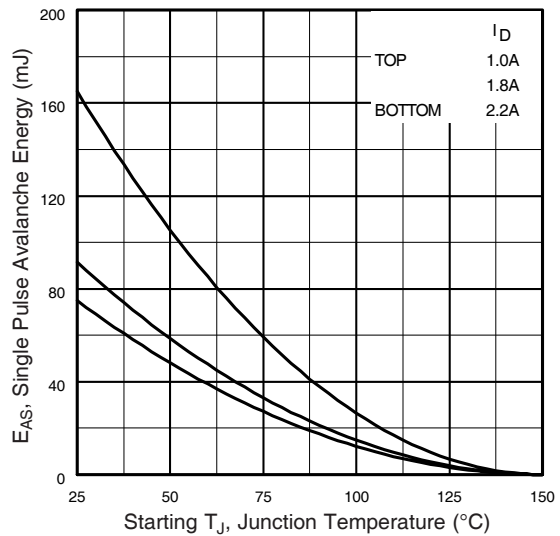
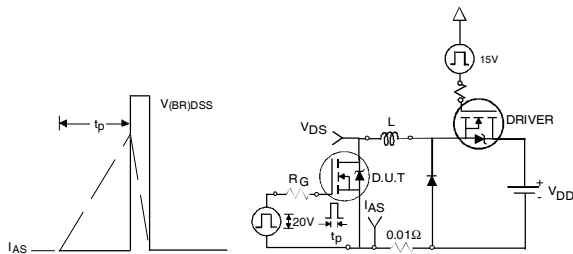
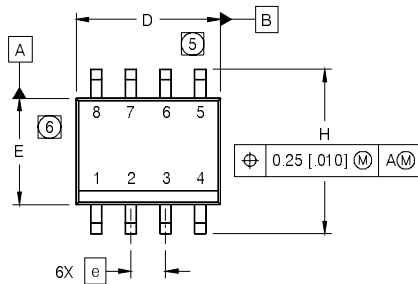

Fig 11. Maximum Effective Transient Thermal Impedance, Junction-to-Case

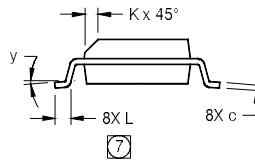
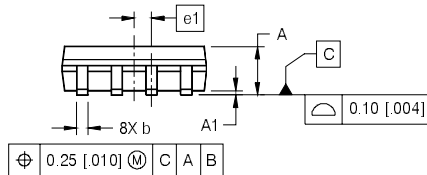

Fig 12. On-Resistance Vs. Drain Current

Fig 13. On-Resistance Vs. Gate Voltage

Fig 14a&b. Basic Gate Charge Test Circuit and Waveform

Fig 15c. Maximum Avalanche Energy Vs. Drain Current

Fig 15a&b. Unclamped Inductive Test circuit and Waveforms

SO-8 Package Outline (MOSFET & Fetky)

Dimensions are shown in millimeters (inches)



DIM	INCHES		MILLIMETERS	
	MIN	MAX	MIN	MAX
A	.0532	.0688	1.35	1.75
A1	.0040	.0098	0.10	0.25
b	.013	.020	0.33	0.51
c	.0075	.0098	0.19	0.25
D	.189	.1968	4.80	5.00
E	.1497	.1574	3.80	4.00
e	.050 BASIC		1.27 BASIC	
e1	.025 BASIC		0.635 BASIC	
H	.2284	.2440	5.80	6.20
K	.0099	.0196	0.25	0.50
L	.016	.050	0.40	1.27
y	0°	8°	0°	8°



- NOTES:
1. DIMENSIONING & TOLERANCING PER ASME Y14.5M-1994.
 2. CONTROLLING DIMENSION: MILLIMETER
 3. DIMENSIONS ARE SHOWN IN MILLIMETERS [INCHES].
 4. OUTLINE CONFORMS TO JEDEC OUTLINE MS-012AA.
 - ⑤ DIMENSION DOES NOT INCLUDE MOLD PROTRUSIONS. MOLD PROTRUSIONS NOT TO EXCEED 0.15 [0.006].
 - ⑥ DIMENSION DOES NOT INCLUDE MOLD PROTRUSIONS. MOLD PROTRUSIONS NOT TO EXCEED 0.25 [0.010].
 - ⑦ DIMENSION IS THE LENGTH OF LEAD FOR SOLDERING TO A SUBSTRATE.

FOOTPRINT

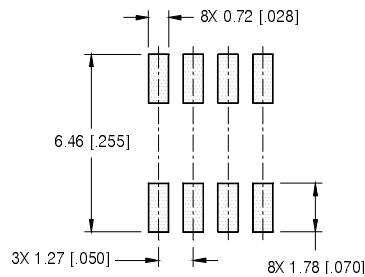

SO-8 Part Marking Information

EXAMPLE: THIS IS AN IRF7101 (MOSFET)

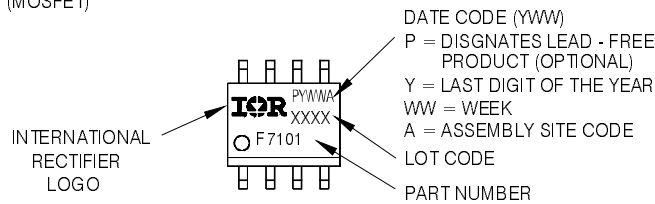

Note: For the most current drawing please refer to IR website at: <http://www.irf.com/package/>

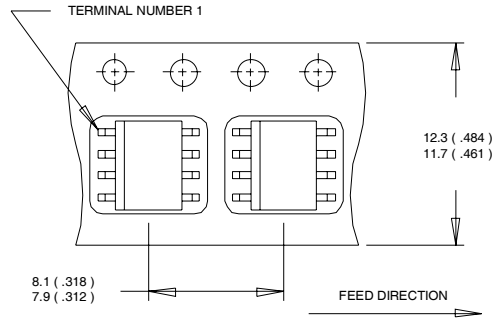
SO-8 Tape and Reel

- NOTES:
1. CONTROLLING DIMENSION : MILLIMETER.
 2. ALL DIMENSIONS ARE SHOWN IN MILLIMETERS(INCHES).
 3. OUTLINE CONFORMS TO EIA-481 & EIA-541.

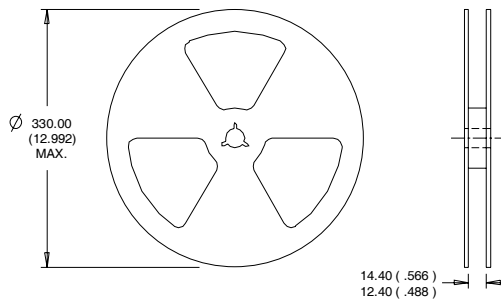

- NOTES:
1. CONTROLLING DIMENSION : MILLIMETER.
 2. OUTLINE CONFORMS TO EIA-481 & EIA-541.

Note: For the most current drawing please refer to IR website at: <http://www.irf.com/package/>

Notes:

- ① Repetitive rating; pulse width limited by max. junction temperature.
- ② Starting $T_J = 25^\circ\text{C}$, $L = 31\text{mH}$, $R_G = 25\Omega$, $I_{AS} = 2.2\text{A}$.
- ③ Pulse width $\leq 400\mu\text{s}$; duty cycle $\leq 2\%$.
- ④ When mounted on 1 inch square copper board.
- ⑤ C_{oss} eff. is a fixed capacitance that gives the same charging time as C_{oss} while V_{DS} is rising from 0 to 80% V_{DSS} .
- ⑥ $I_{SD} \leq 2.2\text{A}$, $di/dt \leq 220\text{A}/\mu\text{s}$, $V_{DD} \leq V_{(BR)DSS}$, $T_J \leq 150^\circ\text{C}$.

Revision History

Date	Comments
09/16/2013	<ul style="list-style-type: none"> • Updated the R_{thja} from $50^\circ\text{C}/\text{W}$ to $62.5^\circ\text{C}/\text{W}$, on page 1. • Converted the data sheet to IR Corporate Template.

International
 Rectifier

IR WORLD HEADQUARTERS: 101 N. Sepulveda Blvd., El Segundo, California 90245, USA
 To contact International Rectifier, please visit <http://www.irf.com/whoto-call/>