

New

# TF037F

## MICRO BLOWERS

### FEATURES

- Aerodynamic bearings
- Compact / Light weight
- High static pressures
- Low vibration
- Long life due to aerodynamic bearings without heat dependence
- Resin in full compliance with FDA standards



### STANDARD SPECIFICATIONS

- Unless otherwise specified, the environmental conditions are 23°C±5°C, normal humidity, and atmospheric pressure range 90 to 106kPa.

No.	Item	Part number	TF037F-2000-F	Remarks
1	Rated Voltage		DC 12 ~ 24 V	
2	Direction of Rotation		CCW (Counter-Clockwise)	Looking down from the air inlet.
3	Kind of Gas		air	Noncorrosive gas
4	Configuration		Motor with Centrifugal Turbo Blade	Without driving circuit
5	Type of Motor		DC Brushless Motor	
6	Number of Poles		8 Poles (4 pole pairs)	
7	Drive System		3 Phase, Bipolar	
8	Bearings		Aerodynamic Bearings	
9	Impeller		Centrifugal Turbo Blade	
10	Mounting Direction		Shaft vertical to ground, air inlet facing upwards	No vibration, shock, or gyration is to be applied during operation.
11	Rated Rotation Speed		31,000 r/min (reference value)	at 2.0kPa, 100L/min
12	Maximum Input Coil Current		3.0 A rms max.	
13	Rated Power Supply Current		0.67 A max.	at 2.0kPa, 100L/min, at 24V
14	Rated Power Consumption		16.1 W max.	
15	Rated Air Flow		100 L/min	at 2.0 kPa
16	Minimum Air Flow		10 L/min	

# TF037F

## MICRO BLOWERS

No.	Item	Specification	Remarks
17	Rated Pressure	2.0 kPa	at 100 L/min
18	Maximum Pressure	3.5 kPa	absolute maximum pressure. at 24VDC
19	Torque Constant	0.0014 ~ 0.0020 N·m/A (reference value)	
20	Min. Rotation Speed	10,000 r/min	
21	Maximum Rotation Speed	45,000 r/min	Within the "Area of use"
22	Acoustic Audible Noise	65.0 dB(A)max.	at 2.0kPa, at 100L/min measured at 1m from air inlet Include background noise 15dB(A)
23	Coil Resistance	0.36 ~ 0.66 Ω (reference value)	at 20°C (Between 2 phase)
24	Coil Inductance	22 ~ 29 μH (reference value)	at 20°C, 10kHz (Between 2 phase)
25	Insulation Class	Class E	JIS C 4003
26	Insulation Resistance	1M Ω min. DC500V (between terminal pins and plate)	JIS C 4003
27	Dielectric Strength	Leak current to be less than 1mA.(AC600V for 1sec. between terminal pins and plate.)	JIS C 4003
28	Weight	72 g (reference value)	
29	Rotor Inertia	19 g·cm <sup>2</sup> (reference value)	
30	Axial Loading	3N max.	maximum axial force applying to the intake (upper housing)
31	Operating Temperature Range	0 ~ 50 °C	
32	Operating Humidity Range	10 ~ 95%RH	No condensation
33	Storage Temperature Range	-20 ~ 60 °C	
34	Storage Humidity Range	10 ~ 95%RH	No condensation
35	Resistance to Vibration	The Blower shall satisfy Specification No.11 ~ 27 after the following test.	
		Kind of Vibration	frequency veering
		Frequency Range	10 ~ 22Hz amplitude 1mm
			22 ~ 50Hz 19.6m/s <sup>2</sup> (2G) (acceleration)
		Sweep	to-and-fro, approx. 5min.
Test Time	X, Y, Z directions, 60min. each		
36	Resistance to Shock	The Blower shall satisfy Specification No.11 ~ 27 after the following test.	
		Acceleration	294m/s <sup>2</sup> (30G)
		Pulse Width	6ms
		Shock Waven	Semi-sinusoidal wave
	Number of Shock	X, Y, Z, directions, once per each direction	

## OPERATING RANGE IN P-Q & Q-I RATING

- P-Q and Q-I conditions must not exceed the ratings listed below.
- The general purpose driver TF037E-1000-D is setup to the configuration for general use. In using the general purpose driver, the output may not reach the maximum ratings listed below.
- P-Q and Q-I characteristics are for reference purpose only. The driver must be configured properly by measuring the actual condition before use.

※ The characteristics below are measured with our company's driver at axis vertical position.  
 ※ Ambient Temperature : 25°C , Barometric Pressure: 101.3kPa

### Characteristics at 12V P-Q/Q-I

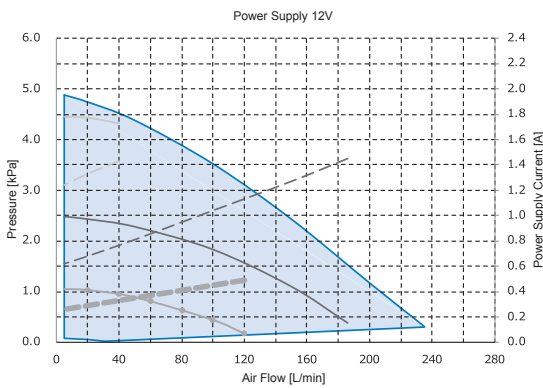

### Characteristics at 24V P-Q/Q-I

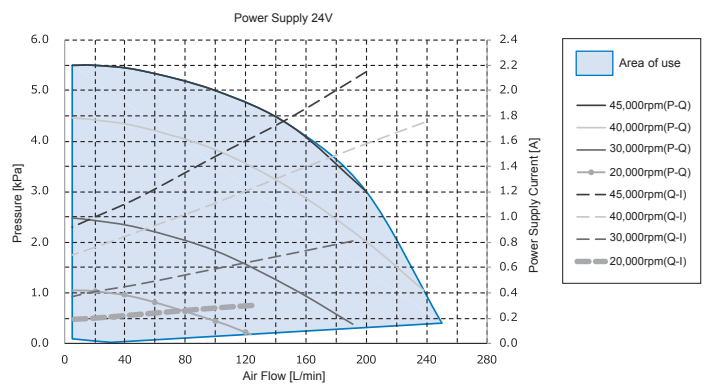

## INTERFACE

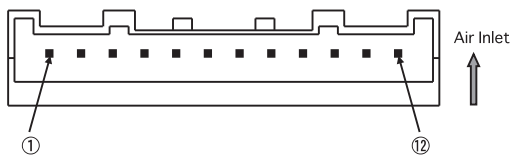

Manufacturer	J.S.T. Mfg. Co., Ltd.
Part No.	SM12B-PASS

### 【Mating Connector】

Manufacturer	J.S.T. Mfg. Co., Ltd.
Part No.	12PAF-6S (insulation displacement connector) (retainer : PAFS-12V-S)
	PAP-12V-S (crimp type) (contact : SPHD-001T-P0.5)

※ Either IDC or crimp type can be used as a mating connector.

Pin No.	Symbol	Signal
1	Vcc	(+12V) Hall Element Power Supply
2	H2-	Hall Element 2 Output
3	H2+	
4	H3-	Hall Element 3 Output
5	H3+	
6	H1-	Hall Element 1 Output
7	H1+	
8	GND	GND
9	TH	Thermistor Output
10	V	Motor Coil (V)
11	W	Motor Coil (W)
12	U	Motor Coil (U)

※ Parts used for thermistor output:  
 Manufacture TDK Corp. Part No. NTCG164BH103JT

### TIMING CHART

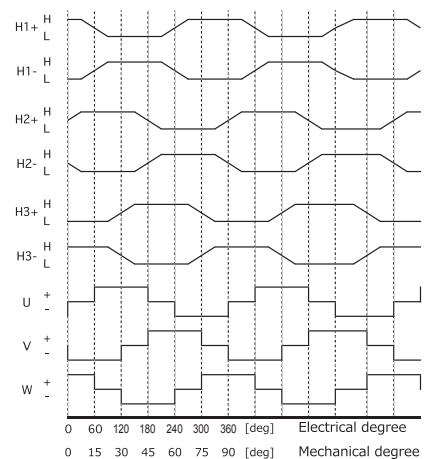

# TF037F MICRO BLOWERS

## OUTLINE DIMENSIONS

Unless otherwise specified, tolerance : ± 0.5(Unit: mm)

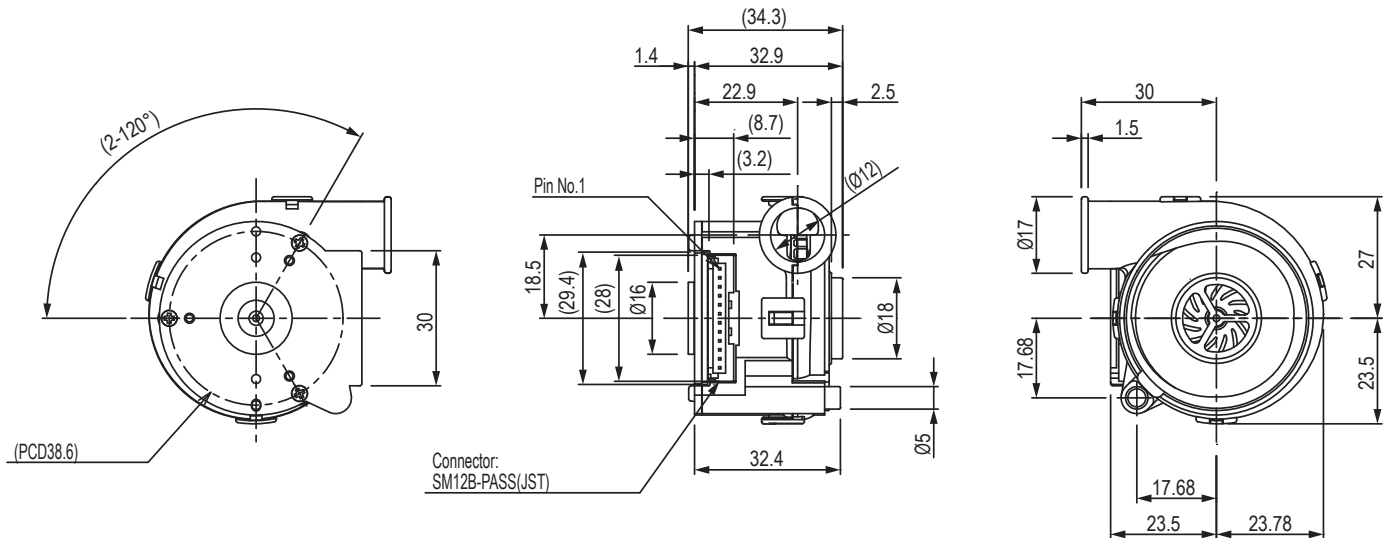

## MARKING

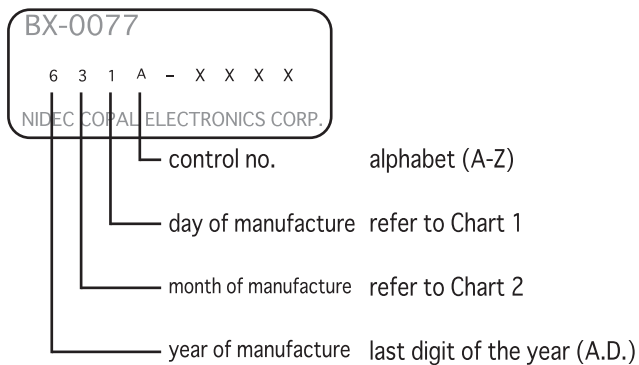

【Chart 1】

day	1	2	3	4	5	6	7	8	9	10	11	12	13	14	15	16	17	18	19	20
code	1	2	3	4	5	6	7	8	9	A	B	C	D	E	F	G	H	J	K	L

day	21	22	23	24	25	26	27	28	29	30	31
code	M	N	P	Q	R	T	U	V	W	X	Y

【Chart 2】

month	1	2	3	4	5	6	7	8	9	10	11	12
code	1	2	3	4	5	6	7	8	9	O	N	D

## Micro Blower Kit with driver

For the series, Kits with driver and wire harness for the blower available. They will help customers shorten their evaluation and product development times.

### ● Kit Part Number : TF037F-2000-P

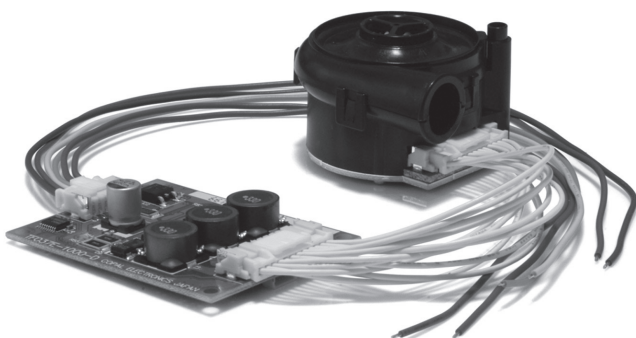

List of the kit	
1	Micro Blower (TF037F-2000-F)
2	Driver (TF037 series common)
3	Wire Harness (for Driver-Blower connection)
4	Wire Harness (for Driver-Power connection)

The Drivers are sold separately as an optional item. (Ref.P430)