

CNY17-1X, CNY17-2X, CNY17-3X, CNY17-4X, CNY17-5X
 CNY17-1, CNY17-2, CNY17-3, CNY17-4, CNY17-5



**OPTICALLY COUPLED
 ISOLATOR
 PHOTOTRANSISTOR OUTPUT**

APPROVALS

- UL recognised, File No. E91231
- 'X' SPECIFICATION APPROVALS
- VDE0884 in 3 available lead forms :-
 - STD
 - G form
 - SMD approved to CECC 00802
- Certified to EN60950 by the following Test Bodies :-
 - Nemko - Certificate No. P01102464
 - Fimko - Certificate No. FI18166
 - Semko - Reference No. 0202037/01-22
 - Demko - Certificate No. 311158-01
- BSI approved - Certificate No. 8001

DESCRIPTION

The CNY17-1, CNY17-2, CNY17-3, CNY17-4, CNY17-5 series of optically coupled isolators consist of an infrared light emitting diode and a NPN silicon photo transistor in a standard 6 pin dual in line plastic package.

FEATURES

- Options :-
 - 10mm lead spread - add G after part no.
 - Surface mount - add SM after part no.
 - Tape&reel - add SMT&R after part no.
- High BV_{CEO} (70V min)
- High Isolation Voltage (5.3kV_{RMS}, 7.5kV_{PK})
- All electrical parameters 100% tested
- Custom electrical selections available

APPLICATIONS

- DC motor controllers
- Industrial systems controllers
- Measuring instruments
- Signal transmission between systems of different potentials and impedances

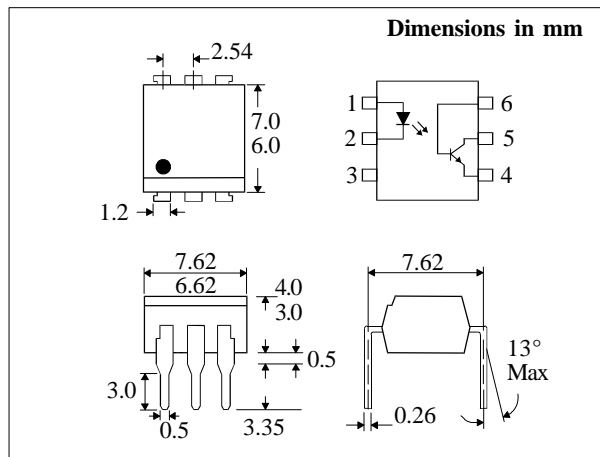
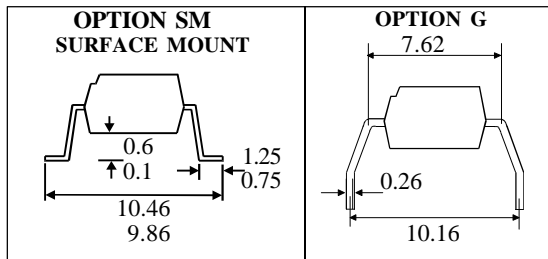

**ABSOLUTE MAXIMUM RATINGS
 (25°C unless otherwise specified)**

Storage Temperature	-55°C to + 150°C
Operating Temperature	-55°C to + 100°C
Lead Soldering Temperature (1/16 inch (1.6mm) from case for 10 secs)	260°C

INPUT DIODE

Forward Current	60mA
Reverse Voltage	6V
Power Dissipation	105mW

OUTPUT TRANSISTOR

Collector-emitter Voltage BV_{CEO}	70V
Collector-base Voltage BV_{CBO}	70V
Emitter-collector Voltage BV_{ECO}	6V
Power Dissipation	160mW

POWER DISSIPATION

Total Power Dissipation	200mW
(derate linearly 2.67mW/°C above 25°C)	

ISOCOM COMPONENTS LTD
 Unit 25B, Park View Road West,
 Park View Industrial Estate, Brenda Road
 Hartlepool, TS25 1YD England Tel: (01429)863609
 Fax: (01429) 863581 e-mail sales@isocom.co.uk
 http://www.isocom.com

ISOCOM INC
 1024 S. Greenville Ave, Suite 240,
 Allen, TX 75002 USA
 Tel: (214)495-0755 Fax: (214)495-0901
 e-mail info@isocom.com
 http://www.isocom.com

ELECTRICAL CHARACTERISTICS ($T_A = 25^\circ\text{C}$ Unless otherwise noted)

PARAMETER		MIN	TYP	MAX	UNITS	TEST CONDITION
Input	Forward Voltage (V_F)		1.2	1.65	V	$I_F = 60\text{mA}$
	Reverse Current (I_R)			10	μA	$V_R = 6\text{V}$
Output	Collector-emitter Breakdown (BV_{CEO})	70			V	$I_C = 1\text{mA}$ (Note 2)
	Collector-base Breakdown (BV_{CBO})	70			V	$I_C = 100\mu\text{A}$
	Emitter-collector Breakdown (BV_{ECO})	6			V	$I_E = 100\mu\text{A}$
	Collector-emitter Dark Current (I_{CEO})			50	nA	$V_{CE} = 10\text{V}$
Coupled	Current Transfer Ratio (CTR) (Note 2)					
	CNY17-1	40	80		%	$10\text{mA } I_F, 5\text{V } V_{CE}$
	CNY17-2	63	125		%	$10\text{mA } I_F, 5\text{V } V_{CE}$
	CNY17-3	100	200		%	$10\text{mA } I_F, 5\text{V } V_{CE}$
	CNY17-4	160	320		%	$10\text{mA } I_F, 5\text{V } V_{CE}$
	CNY17-5	200	400		%	$10\text{mA } I_F, 5\text{V } V_{CE}$
	CNY17-1	13			%	$1\text{mA } I_F, 5\text{V } V_{CE}$
	CNY17-2	22			%	$1\text{mA } I_F, 5\text{V } V_{CE}$
	CNY17-3	34			%	$1\text{mA } I_F, 5\text{V } V_{CE}$
	CNY17-4	56			%	$1\text{mA } I_F, 5\text{V } V_{CE}$
	CNY17-5	68			%	$1\text{mA } I_F, 5\text{V } V_{CE}$
	Collector-emitter Saturation Voltage $V_{CE(SAT)}$			0.4	V	$10\text{mA } I_F, 2.5\text{mA}$
	Input to Output Isolation Voltage V_{ISO}	5300			V_{RMS}	See note 1
Input-output Isolation Resistance R_{ISO}	5×10^{10}			Ω	$V_{IO} = 500\text{V}$ (note 1)	

Note 1 Measured with input leads shorted together and output leads shorted together.

Note 2 Special Selections are available on request. Please consult the factory.

TYPICAL SWITCHING CHARACTERISTICS

1. Linear Operation (without saturation) Fig 1.
 $I_F = 10\text{mA}, V_{CC} = 5\text{V}, R_L = 75\Omega$

			UNITS
Turn-on Time	t_{on}	3.0	μs
Rise Time	t_r	2.0	μs
Turn-off Time	t_{off}	2.3	μs
Fall Time	t_f	2.0	μs
Cut-off Frequency	F_{CO}	250	kHz

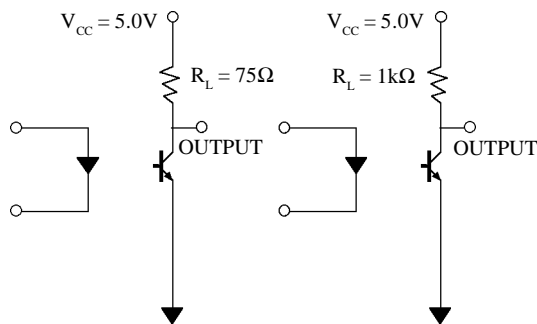
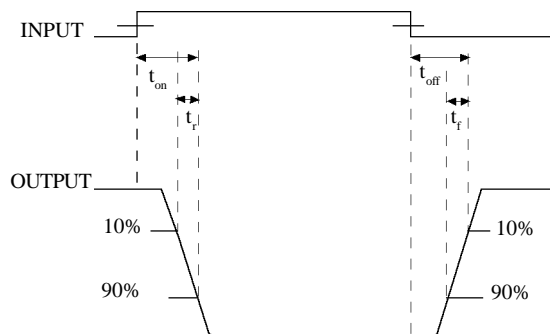

FIG 1

FIG 2

2. Switching Operation (with saturation) Fig 2
 $V_{CC} = 5\text{V}, R_L = 1\text{k}\Omega$

GROUP	-1 ($I_F = 20\text{mA}$)	-2 and -3 ($I_F = 10\text{mA}$)	-4 ($I_F = 5\text{mA}$)	UNITS	
Turn-on Time	t_{on}	3.0	4.2	6.0	μs
Rise Time	t_r	2.0	3.0	4.6	μs
Turn-off Time	t_{off}	18	23	25	μs
Fall Time	t_f	11	14	15	μs
V_{CESAT}				≤ 0.4	V



Collector Power Dissipation vs. Ambient Temperature

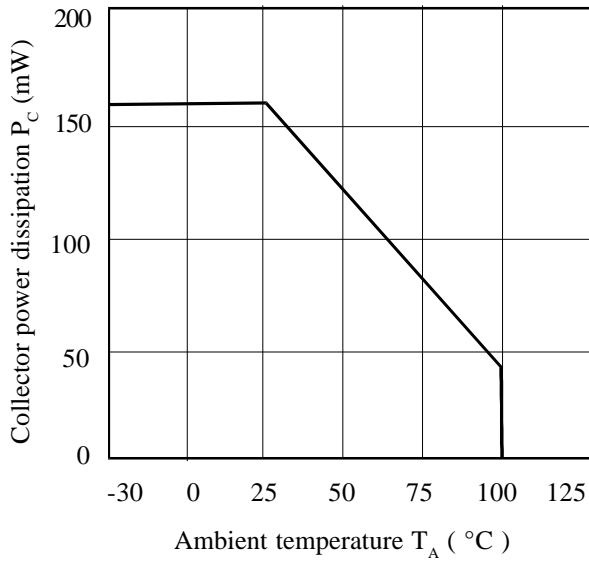

Collector Current vs. Collector-emitter Voltage (normalised to CNY17-3)

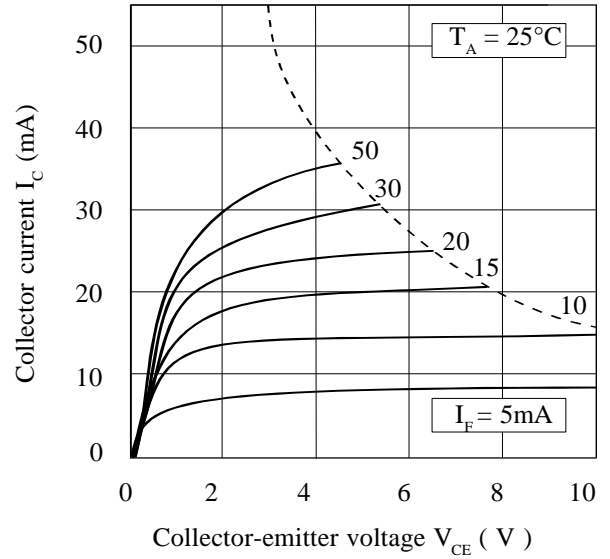

Forward Current vs. Ambient Temperature

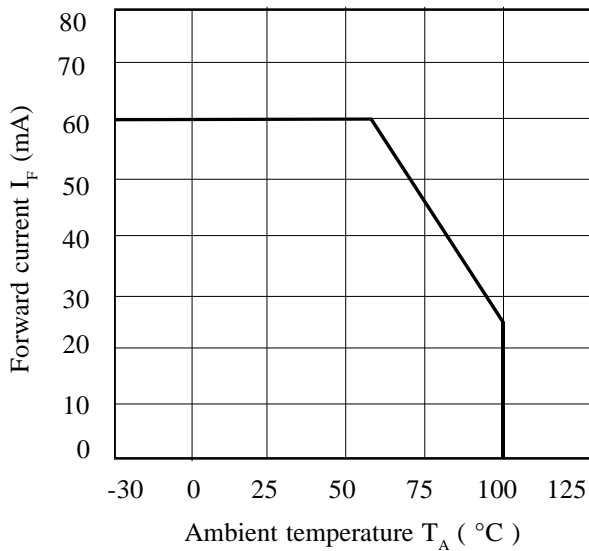

Current Transfer Ratio vs. Forward Current

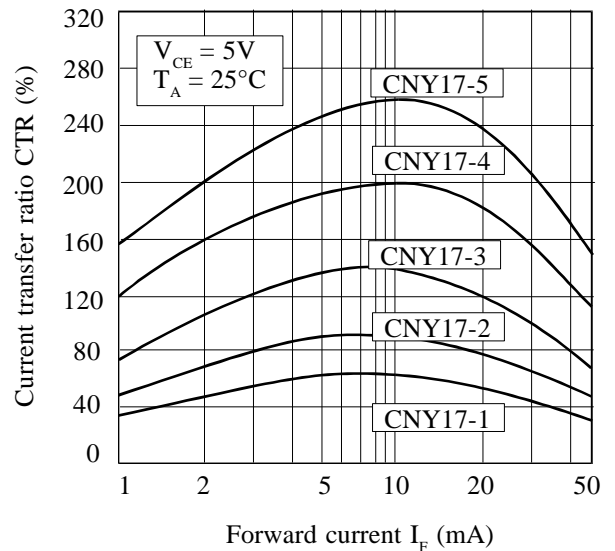

Relative Current Transfer Ratio vs. Ambient Temperature



Collector-emitter Saturation Voltage vs. Ambient Temperature

