



IS181



DESCRIPTION

The IS181 series of optocoupler consists of an infrared light emitting diode optically coupled to an NPN silicon photo transistor in a space efficient Mini Flat Package.

FEATURES

- Low Profile Package
- AC Isolation Voltage 3750V_{RMS}
- CTR Selections Available
- Wide Operating Temperature Range -55°C to +110°C
- Lead Free and RoHS Compliant
- UL File E91231 model "FPT1" and "FPT2"

APPLICATIONS

- Computer Terminals
- Industrial System Controllers
- Measuring Instruments
- Signal Transmission between Systems of Different Potentials and Impedance

ORDER INFORMATION

- Available in Tape and Reel with 3000 pieces per reel

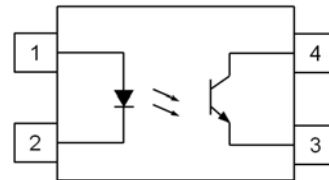

- 1 Anode
- 2 Cathode
- 3 Emitter
- 4 Collector

ABSOLUTE MAXIMUM RATINGS (T_A = 25°C)

Stresses exceeding the absolute maximum ratings can cause permanent damage to the device. Exposure to absolute maximum ratings for long periods of time can adversely affect reliability.

Input

Forward Current	50mA
Reverse Voltage	6V
Power dissipation	70mW

Output

Collector to Emitter Voltage BV _{CEO}	80V
Emitter to Collector Voltage BV _{ECO}	6V
Collector Current	50mA
Power Dissipation	150mW

Total Package

Isolation Voltage	3750V _{RMS}
Total Power Dissipation	170mW
Operating Temperature	-55 to 110 °C
Storage Temperature	-55 to 150 °C
Lead Soldering Temperature (10s)	260°C

ISOCOM COMPONENTS 2004 LTD

Unit 25B, Park View Road West, Park View Industrial Estate
Hartlepool, Cleveland, TS25 1PE, United Kingdom
Tel : +44 (0)1429 863 609 Fax : +44 (0)1429 863 581
e-mail : sales@isocom.co.uk
<http://www.isocom.com>

ISOCOM COMPONENTS ASIA LTD

Hong Kong Office,
Block A, 8/F, Wah Hing Industrial mansion,
36 Tai Yau Street, San Po Kong, Kowloon, Hong Kong.
Tel : +852 2995 9217 Fax : +852 8161 6292
e-mail : sales@isocom.com.hk



IS181

ELECTRICAL CHARACTERISTICS ($T_A = 25^\circ\text{C}$ unless otherwise specified)

INPUT

Parameter	Symbol	Test Condition	Min	Typ.	Max	Unit
Forward Voltage	V_F	$I_F = 20\text{mA}$		1.2	1.4	V
Reverse Current	I_R	$V_R = 4\text{V}$			10	μA
Terminal Capacitance	C_t	$V = 0\text{V}, f = 1\text{KHz}$		30	250	pF

OUTPUT

Parameter	Symbol	Test Condition	Min	Typ.	Max	Unit
Collector-Emitter Breakdown Voltage	BV_{CEO}	$I_C = 0.1\text{mA}, I_F = 0\text{mA}$	80			V
Emitter-Collector Breakdown Voltage	BV_{ECO}	$I_E = 10\mu\text{A}, I_F = 0\text{mA}$	6			V
Collector-Emitter Dark Current	I_{CEO}	$V_{CE} = 20\text{V}, I_F = 0\text{mA}$			100	nA

COUPLED

Parameter	Symbol	Test Condition	Min	Typ.	Max	Unit
Current Transfer Ratio	CTR	$I_F = 5\text{mA}, V_{CE} = 5\text{V}$	50		600	%
		Optional CTR Grades				
		IS181A	80		160	
		IS181B	130		260	
		IS181C	200		400	
		IS181D	300		600	
		IS181GR	100		300	
IS181GB	100		600			
Collector-Emitter Saturation Voltage	$V_{CE(sat)}$	$I_F = 20\text{mA}, I_C = 1\text{mA}$			0.2	V
Floating Capacitance	C_f	$V = 0\text{V}, f = 1\text{MHz}$		0.6	1	pF
Output Rise Time	t_r	$V_{CE} = 2\text{V}, I_C = 2\text{mA}, R_L = 100\Omega$		4	18	μs
Output Fall Time	t_f	$V_{CE} = 2\text{V}, I_C = 2\text{mA}, R_L = 100\Omega$		3	18	μs

ISOLATION

Parameter	Symbol	Test Condition	Min	Typ.	Max	Unit
Insulation Voltage	V_{ISO}	$RH = 40\% \text{ to } 60\%, t = 1 \text{ min},$	3750			V
Input - Output Resistance	R_{I-O}	$V_{I-O} = 500\text{VDC}$	5×10^{10}			Ω



IS181

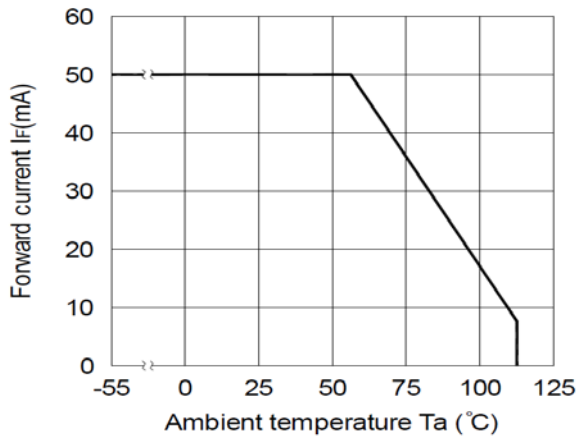

Fig 1 Forward Current vs T_A

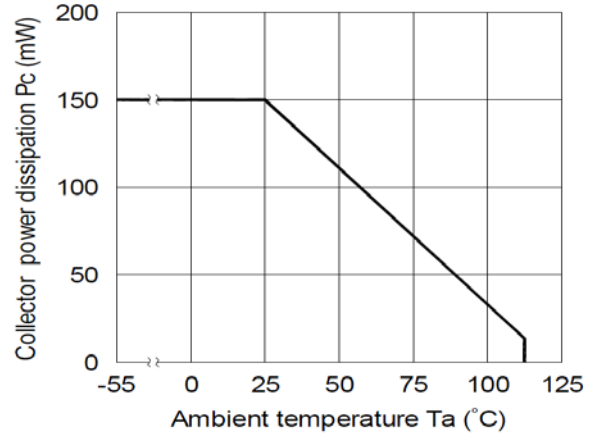

Fig 2 Collector Power Dissipation vs T_A

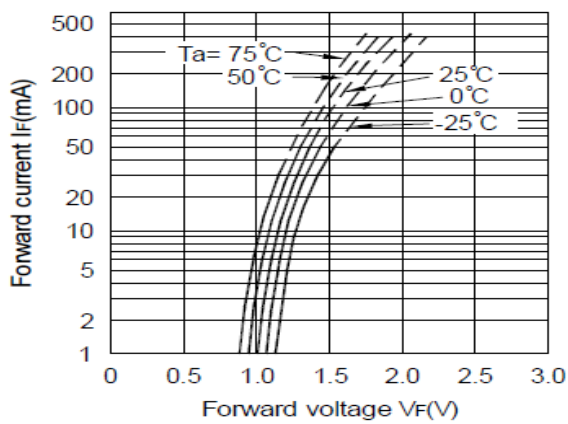

Fig 3 Forward Current vs Forward Voltage

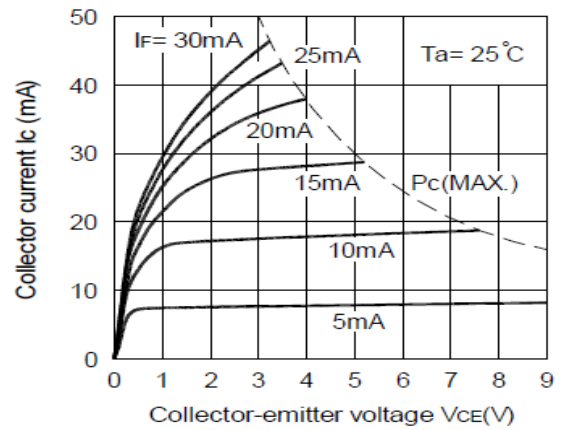

Fig 4 Collector Current vs Collector-Emitter Voltage

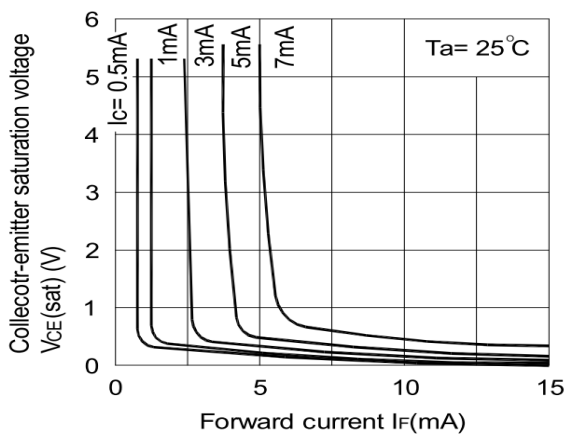

Fig 5 Collector-Emitter Saturation Voltage vs Forward Current

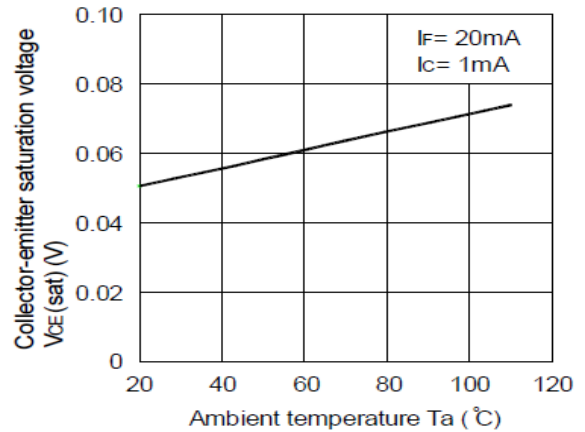

Fig 6 Collector-Emitter Saturation Voltage vs T_A

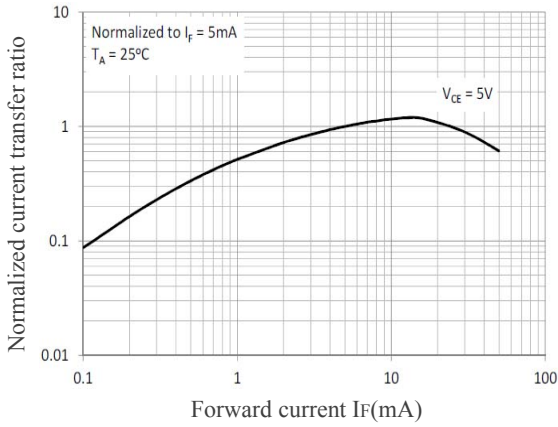

Fig 7 Normalized Current Transfer Ratio vs Forward Current

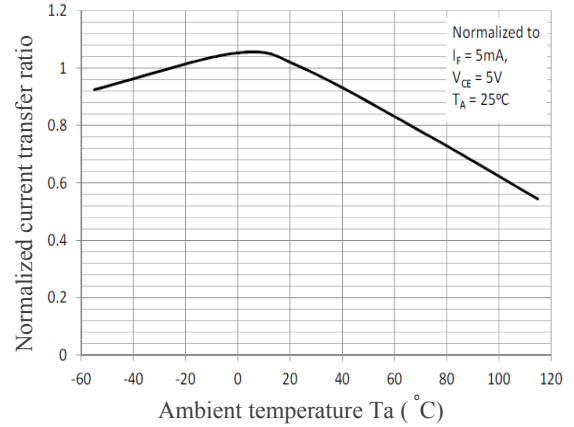

Fig 8 Normalized Current Transfer Ratio vs T_A

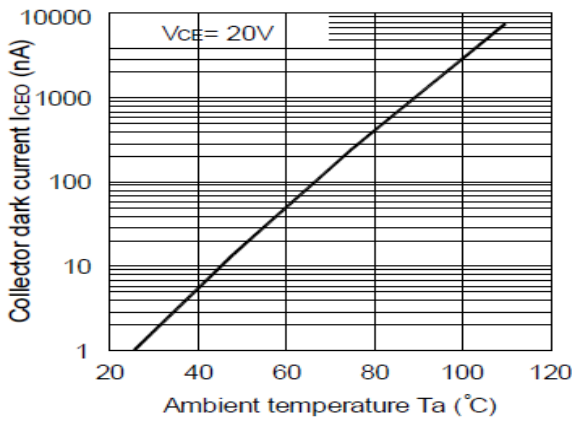

Fig 9 Collector Dark Current vs T_A

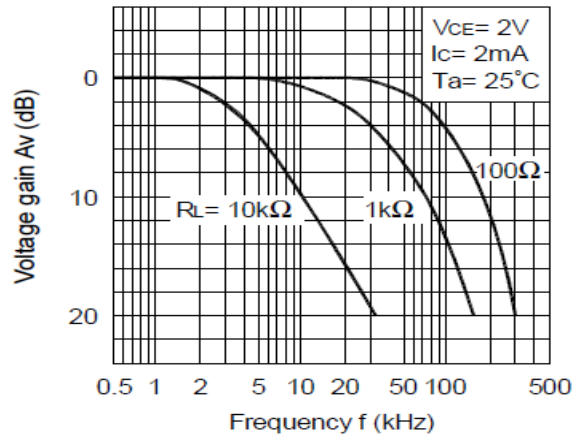

Fig 10 Frequency response

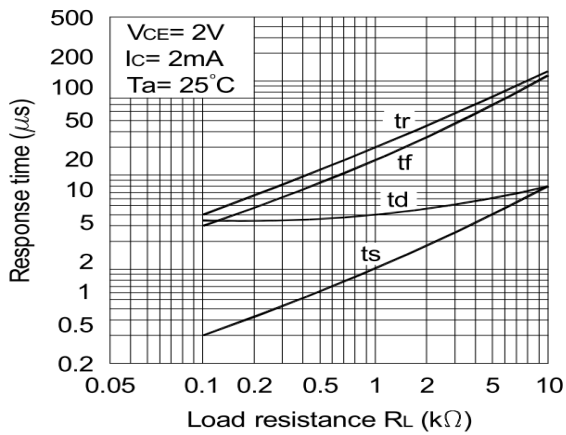
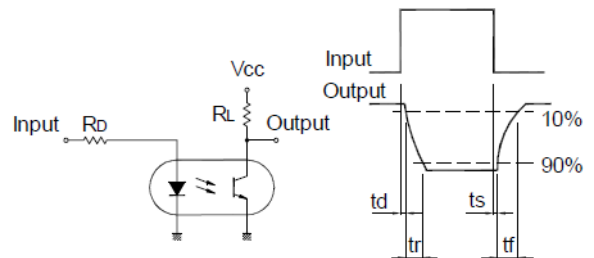

Fig 11 Response Time vs Load Resistance





IS181

ORDER INFORMATION

IS181			
After PN	PN	Description	Packing quantity
None	IS181	Surface Mount Tape & Reel	3000 pcs per reel
Any CTR Grade	IS181A, IS181B, IS181C, IS181D, IS181GR, IS181GB	Surface Mount Tape & Reel	3000 pcs per reel

DEVICE MARKING

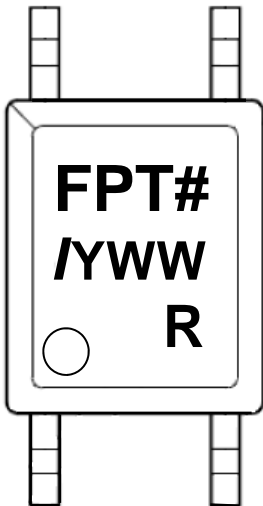

- FPT#** denotes Device Part Number where “#” is internal control number which can be “1” or “2”
- /** denotes Isocom
- Y** denotes 1 digit Year code
- WW** denotes 2 digit Week code
- R** denotes CTR Grade



IS181

PACKAGE DIMENSIONS (mm)

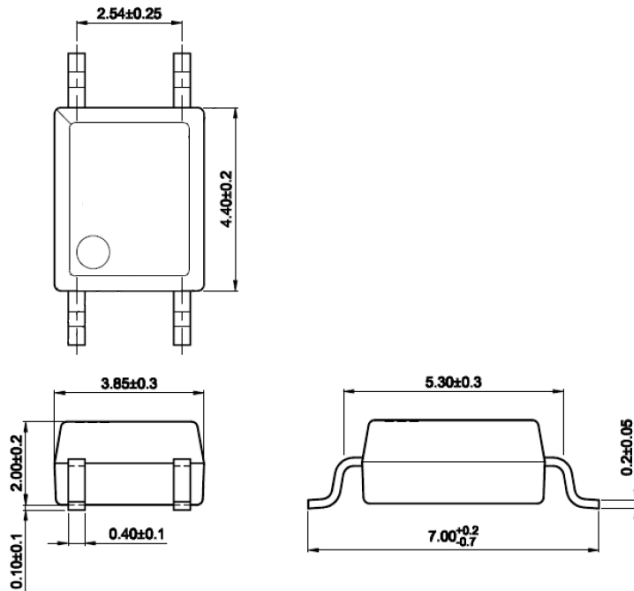

RECOMMENDED SOLDER PAD LAYOUT (mm)

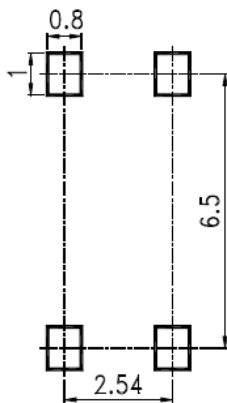



IS181

IR REFLOW SOLDERING TEMPERATURE PROFILE
(One Time Reflow Soldering is Recommended)

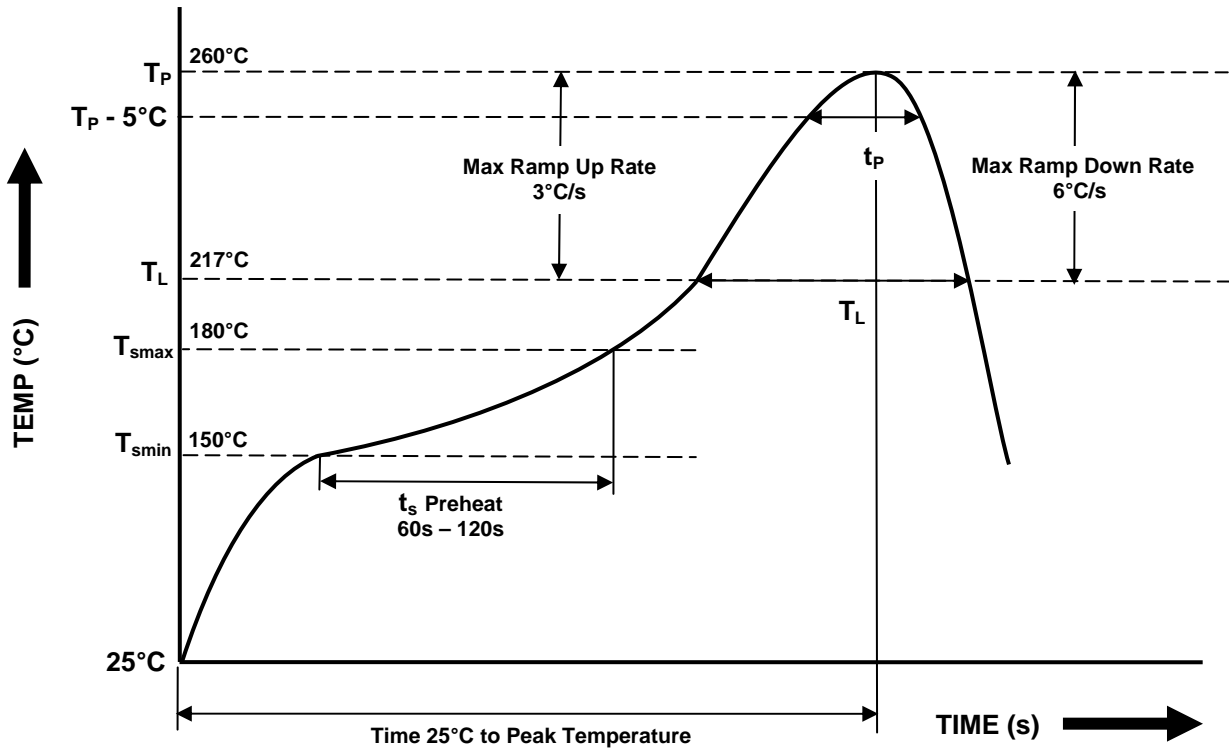

Profile Details	Conditions
Preheat - Min Temperature (T_{SMIN}) - Max Temperature (T_{SMAX}) - Time T_{SMIN} to T_{SMAX} (t_s)	150°C 180°C 60s - 120s
Soldering Zone - Peak Temperature (T_P) - Liquidous Temperature (T_L) - Time within 5°C of Actual Peak Temperature ($T_P - 5°C$) - Time maintained above T_L (t_L) - Ramp Up Rate (T_L to T_P) - Ramp Down Rate (T_P to T_L)	260°C 217°C 20s 60s 3°C/s max 3 - 6°C/s
Average Ramp Up Rate (T_{smax} to T_P)	3°C/s max
Time 25°C to Peak Temperature	8 minutes max



IS181

TAPE AND REEL PACKAGING

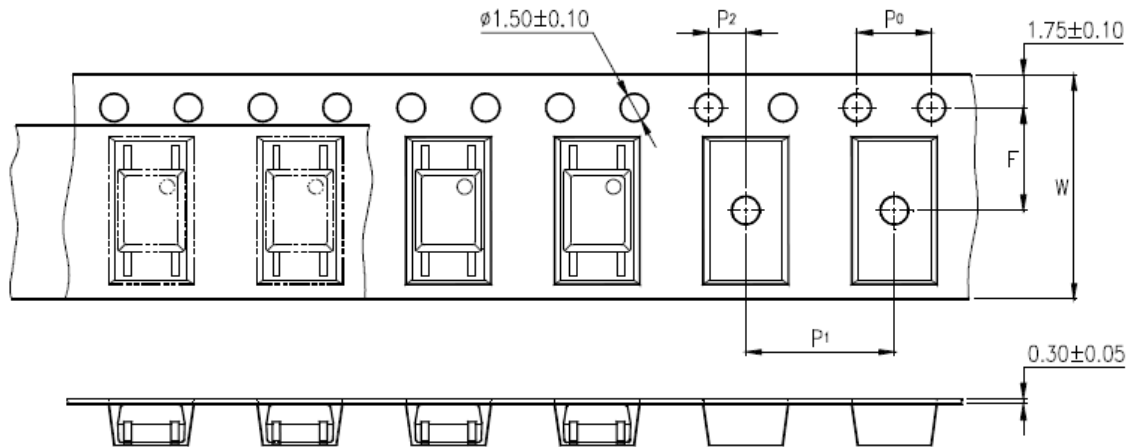

Description	Symbol	Dimension mm (inch)
Tape Width	W	12 ± 0.3 (0.47)
Pitch of Sprocket Holes	P_0	4 ± 0.1 (0.15)
Distance of Compartment to Sprocket Holes	F	5.5 ± 0.1 (0.217)
	P_2	2 ± 0.1 (0.079)
Distance of Compartment to Compartment	P_1	8 ± 0.1 (0.315)



NOTES :

- Isocom is continually improving the quality, reliability, function or design and Isocom reserves the right to make changes without further notices.
- The products shown in this publication are designed for the general use in electronic applications such as office automation equipment, communications devices, audio/visual equipment, electrical application and instrumentation.
- For equipment/application where high reliability or safety is required, such as space applications, nuclear power control equipment, medical equipment, etc., please contact our sales representatives.
- When requiring a device for any "specific" application, please contact our sales for advice.
- The contents described herein are subject to change without prior notice.
- Do not immerse device body in solder paste.



DISCLAIMER

ISOCOM is continually working to improve the quality and reliability of its products. Nevertheless, semiconductor devices in general can malfunction or fail due to their inherent electrical sensitivity and vulnerability to physical stress. It is the responsibility of the buyer, when utilizing ISOCOM products, to comply with the standards of safety in making a safe design for the entire system, and to avoid situations in which a malfunction or failure of such ISOCOM products could cause loss of human life, bodily injury or damage to property.

In developing your designs, please ensure that ISOCOM products are used within specified operating ranges as set forth in the most recent ISOCOM products specifications.

__ The ISOCOM products listed in this document are intended for usage in general electronics applications (computer, personal equipment, office equipment, measuring equipment, industrial robotics, domestic appliances, etc.). These ISOCOM products are neither intended nor warranted for usage in equipment that requires extraordinarily high quality and/or reliability or a malfunction or failure of which may cause loss of human life or bodily injury ("Unintended Usage"). Unintended Usage include atomic energy control instruments, airplane or spaceship instruments, transportation Instruments, traffic signal instruments, combustion control instruments, medical Instruments, all types of safety devices, etc.. Unintended Usage of ISOCOM products listed in this document shall be made at the customer's own risk.

__ Gallium arsenide (GaAs) is a substance used in the products described in this document. GaAs dust and fumes are toxic. Do not break, cut or pulverize the product, or use chemicals to dissolve them. When disposing of the products, follow the appropriate regulations. Do not dispose of the products with other industrial waste or with domestic garbage.

__ The products described in this document are subject to the foreign exchange and foreign trade laws.

__ The information contained herein is presented only as a guide for the applications of our products. No responsibility is assumed by ISOCOM Components for any infringements of intellectual property or other rights of the third parties which may result from its use. No license is granted by implication or otherwise under any intellectual property or other rights of ISOCOM Components or others.

__ The information contained herein is subject to change without notice