



## HIGH DENSITY MOUNTING PHOTOTRANSISTOR OPTICALLY COUPLED ISOLATORS

### DESCRIPTION

The IS357 is an optically coupled isolator consisting of an infrared light emitting diode and NPN silicon photo transistor in a space efficient dual in line plastic package.

### FEATURES

- Marked as FPT1.
- Current Transfer Ratio MIN. 50%
- Isolation Voltage (3.75kV<sub>RMS</sub>, 5.3kV<sub>PK</sub>)
- All electrical parameters 100% tested
- Drop in replacement for Sharp PC357

### APPLICATIONS

- Computer terminals
- Industrial systems controllers
- Measuring instruments
- Signal transmission between systems of different potentials and impedances

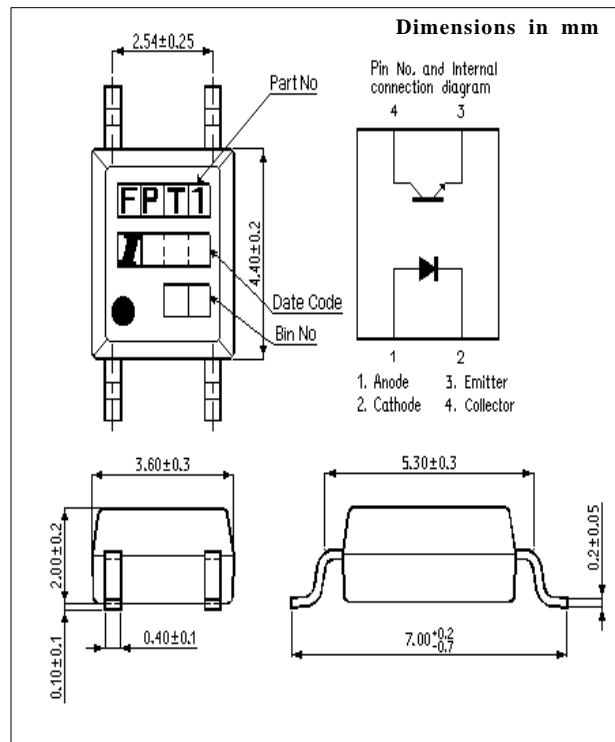

**ISOCOM COMPONENTS LTD**  
Unit 25B, Park View Road West,  
Park View Industrial Estate, Brenda Road  
Hartlepool, Cleveland, TS25 1YD  
Tel: (01429) 863609 Fax : (01429) 863581

**ISOCOM INC**  
1024 S. Greenville Ave, Suite 240,  
Allen, TX 75002 USA  
Tel: (214) 495-0755 Fax: (214) 495-0901  
e-mail info@isocom.com  
http://www.isocom.com

**ABSOLUTE MAXIMUM RATINGS**  
(25°C unless otherwise specified)

Storage Temperature \_\_\_\_\_ -40°C to +125°C  
 Operating Temperature \_\_\_\_\_ -30°C to +100°C  
 Lead Soldering Temperature  
 (1/16 inch (1.6mm) from case for 10 secs) 260°C

**INPUT DIODE**

Forward Current \_\_\_\_\_ 50mA  
 Reverse Voltage \_\_\_\_\_ 6V  
 Power Dissipation \_\_\_\_\_ 70mW

**OUTPUT TRANSISTOR**

Collector-emitter Voltage  $BV_{CEO}$  \_\_\_\_\_ 35V  
 Emitter-collector Voltage  $BV_{ECO}$  \_\_\_\_\_ 6V  
 Power Dissipation \_\_\_\_\_ 150mW

**POWER DISSIPATION**

Total Power Dissipation \_\_\_\_\_ 170mW  
 (derate linearly 2.26mW/°C above 25°C)

**ELECTRICAL CHARACTERISTICS (  $T_A = 25^\circ\text{C}$  Unless otherwise noted )**

PARAMETER		MIN	TYP	MAX	UNITS	TEST CONDITION	
Input	Forward Voltage ( $V_F$ )		1.2	1.4	V	$I_F = 20\text{mA}$	
	Reverse Voltage ( $V_R$ )	5			V	$I_R = 10\mu\text{A}$	
	Reverse Current ( $I_R$ )			10	$\mu\text{A}$	$V_R = 4\text{V}$	
Output	Collector-emitter Breakdown ( $BV_{CEO}$ )	35			V	$I_C = 0.5\text{mA}$	
	Emitter-collector Breakdown ( $BV_{ECO}$ )	6			V	$I_E = 0.1\text{mA}$	
	Collector-emitter Dark Current ( $I_{CEO}$ )			100	nA	$V_{CE} = 20\text{V}$	
Coupled	Current Transfer Ratio (CTR)	50		600	%	$5\text{mA } I_F, 5\text{V } V_{CE}$	
	Optional CTR Grades:	IS357A	80		160	%	$5\text{mA } I_F, 5\text{V } V_{CE}$
		IS357B	130		260	%	$5\text{mA } I_F, 5\text{V } V_{CE}$
		IS357C	200		400	%	$5\text{mA } I_F, 5\text{V } V_{CE}$
		IS357D	300		600	%	$5\text{mA } I_F, 5\text{V } V_{CE}$
	Collector-emitter Saturation Voltage $V_{CE(SAT)}$			0.2	V	$20\text{mA } I_F, 1.0\text{mA } I_C$	
	Input to Output Isolation Voltage $V_{ISO}$	3750 5300			$V_{RMS}$ $V_{PK}$	See note 1 See note 1	
Input-output Isolation Resistance $R_{ISO}$	$5 \times 10^{10}$			$\Omega$	$V_{IO} = 500\text{V}$ (note 1)		
Output Rise Time $t_r$		4	18	$\mu\text{s}$	$V_{CE} = 2\text{V}$ ,		
Output Fall Time $t_f$		3	18	$\mu\text{s}$	$I_C = 2\text{mA}, R_L = 100\Omega$		

Note 1 Measured with input leads shorted together and output leads shorted together.

## TAPING DIMENSIONS

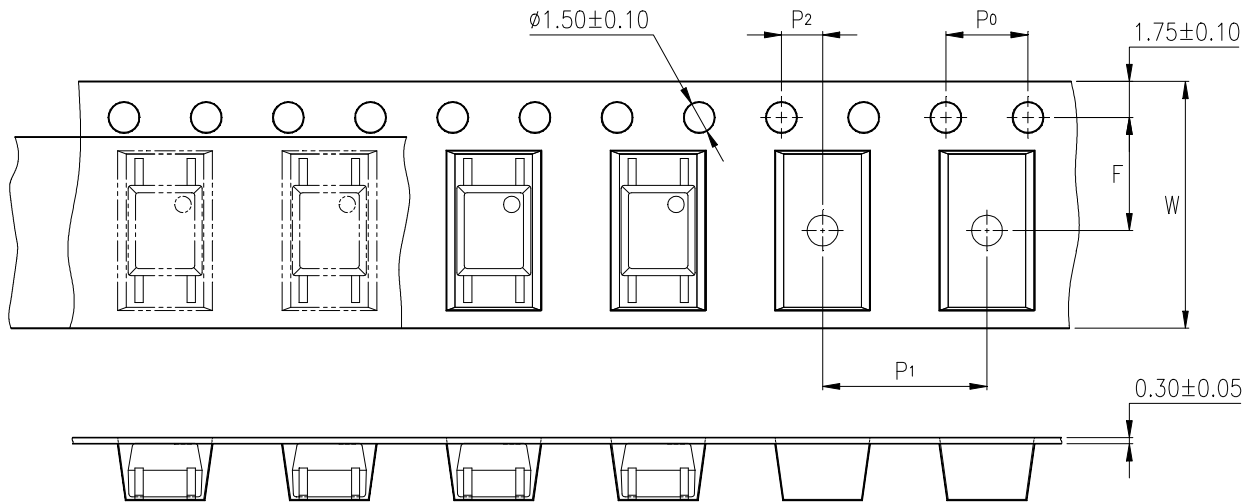

Description	Symbol	Dimensions in mm ( inches )
Tape wide	W	$12 \pm 0.3$ ( .47 )
Pitch of sprocket holes	$P_0$	$4 \pm 0.1$ ( .15 )
Distance of compartment	F	$5.5 \pm 0.1$ ( .217 )
	$P_2$	$2 \pm 0.1$ ( .079 )
Distance of compartment to compartment	$P_1$	$8 \pm 0.1$ ( .315 )

# CHARACTERISTIC CURVES

Fig.1 Forward Current vs. Ambient Temperature

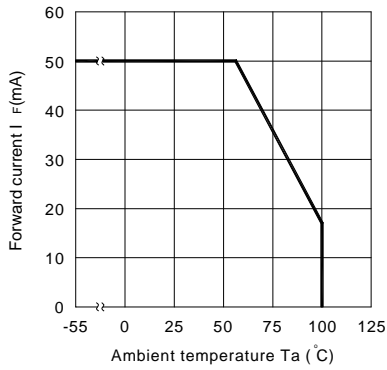

Fig.2 Collector Power Dissipation vs. Ambient Temperature

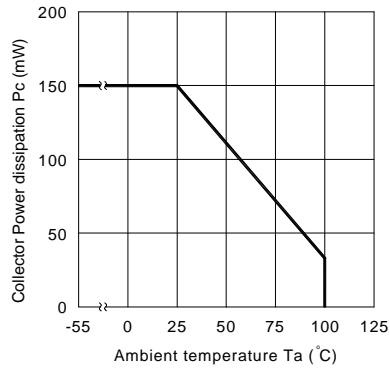

Fig.3 Collector-emitter Saturation Voltage vs. Forward Current

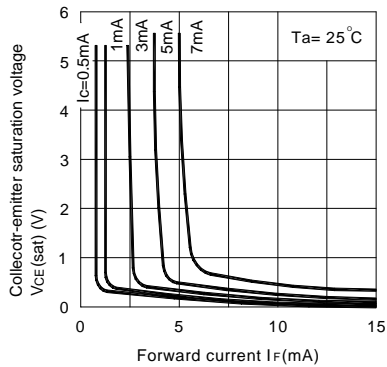

Fig.4 Forward Current vs. Forward Voltage

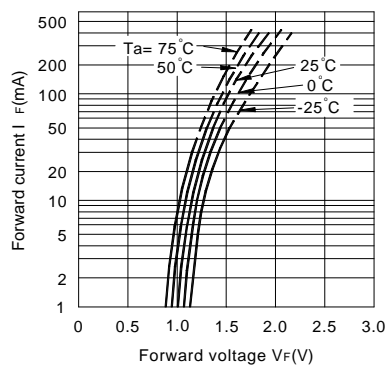

Fig.5 Current Transfer Ratio vs. Forward Current

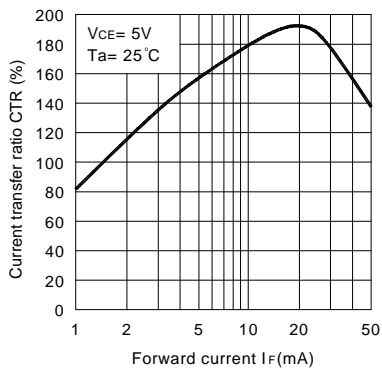
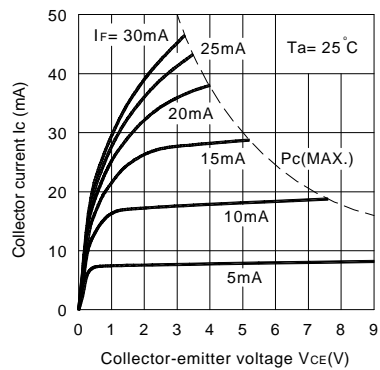

Fig.6 Collector Current vs. Collector-emitter Voltage



# CHARACTERISTIC CURVES

Fig.7 Relative Current Transfer Ratio vs. Ambient Temperature

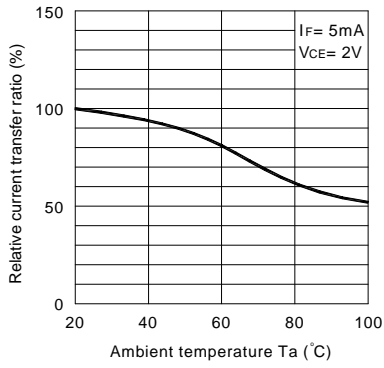

Fig.8 Collector-emitter Saturation Voltage vs. Ambient Temperature

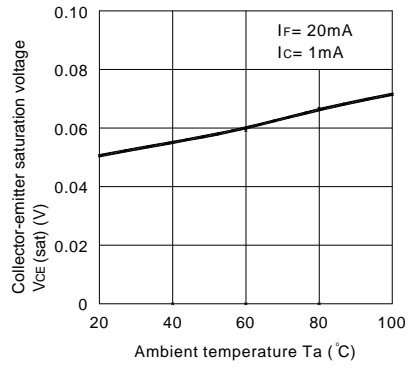

Fig.9 Collector Dark Current vs. Ambient Temperature

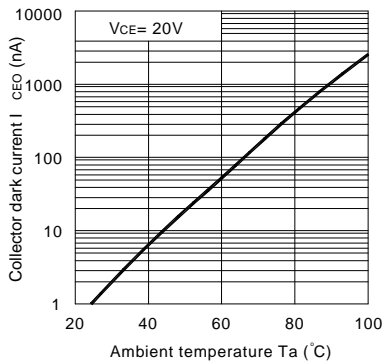

Fig.10 Response Time vs. Load Resistance

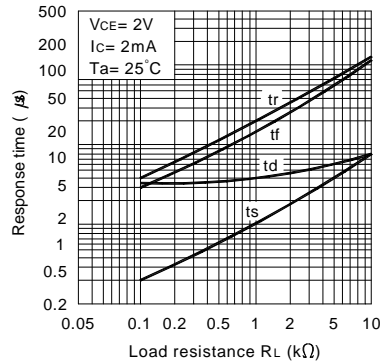
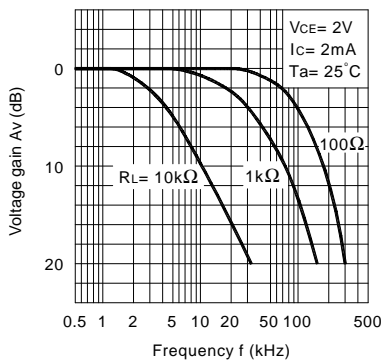
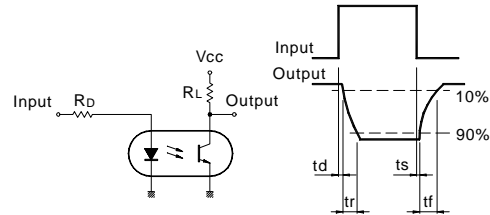

Fig.11 Frequency Response



Test Circuit for Response Time



Test Circuit for Frequency Response

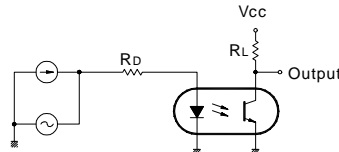

## TEMPERATURE PROFILE OF SOLDERING REFLOW

- (1) One time soldering reflow is recommended within the condition of temperature and time profile shown below.

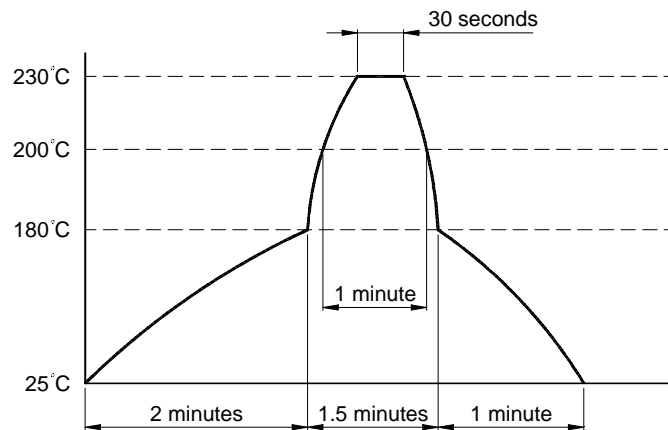

- (2) When using another soldering method such as infrared ray lamp, the temperature may rise partially in the mold of the device.  
Keep the temperature on the package of the device within the condition of above (1).