

Customer Information Sheet

DRAWING No.: G125-MH1XX05M4P

IF IN DOUBT - ASK

©

NOT TO SCALE

THIRD ANGLE PROJECTION

ALL DIMENSIONS IN mm

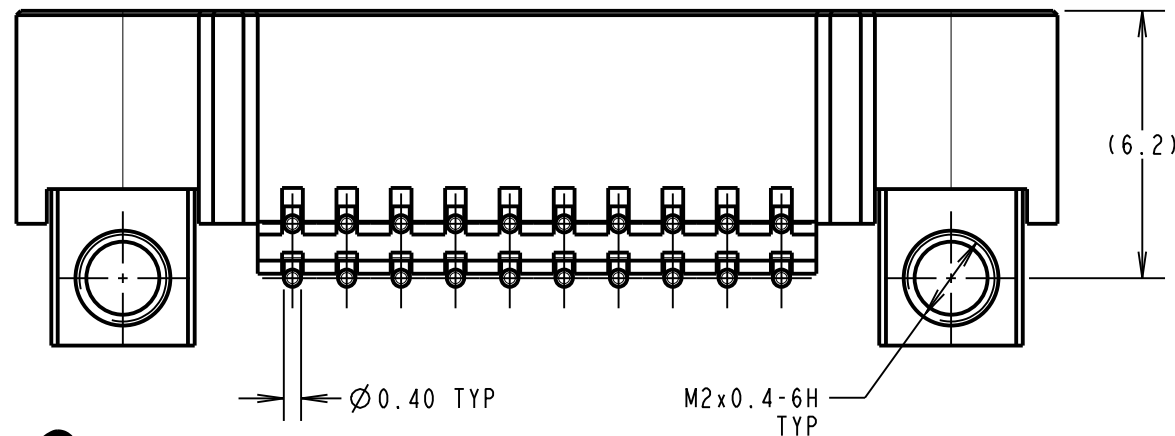
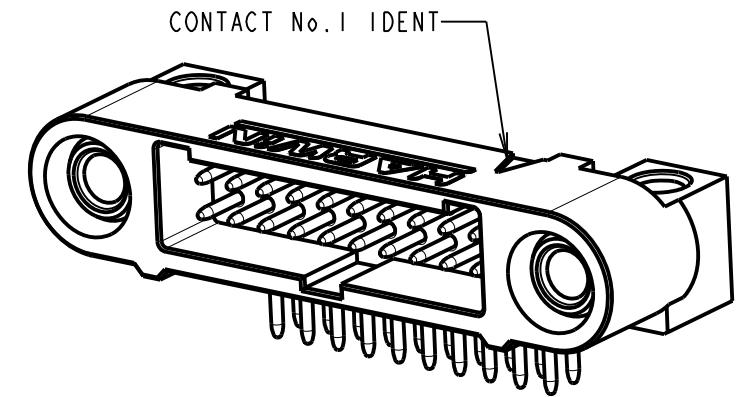
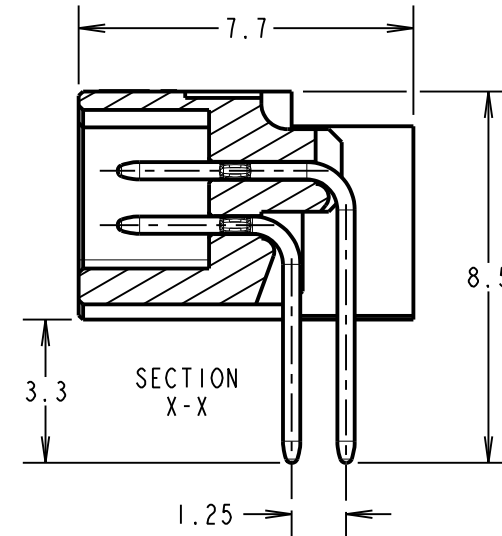
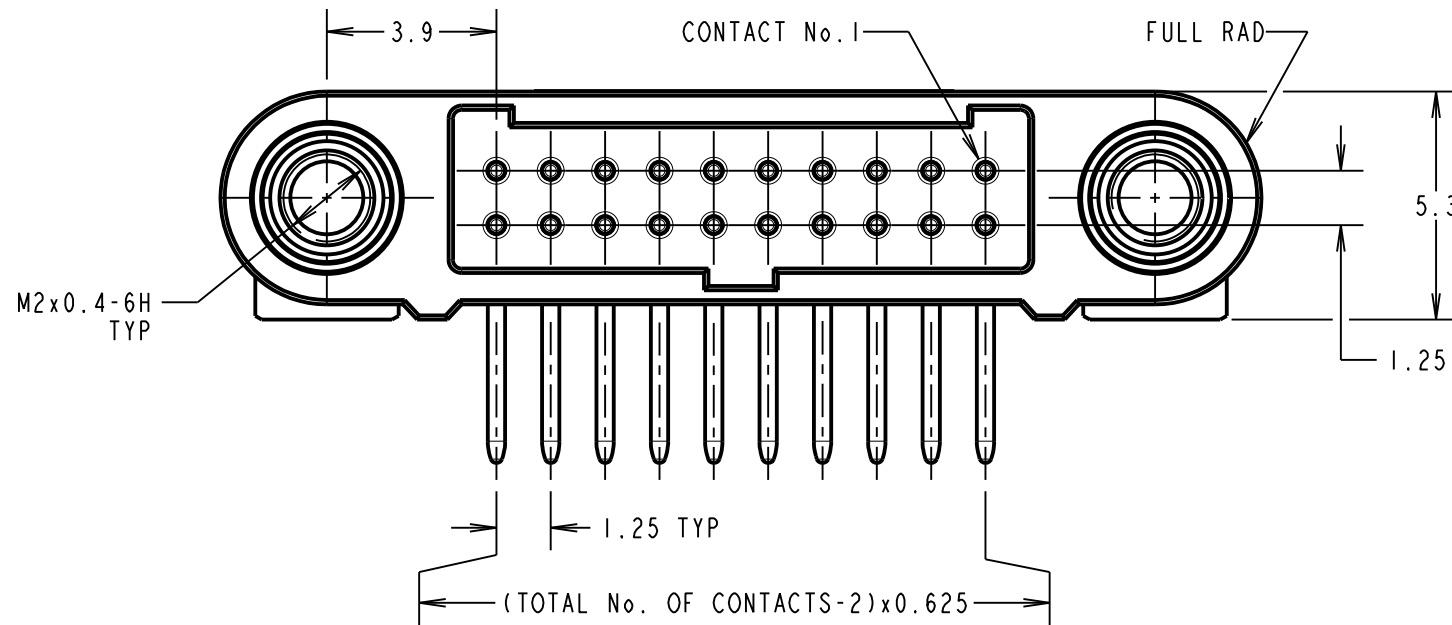
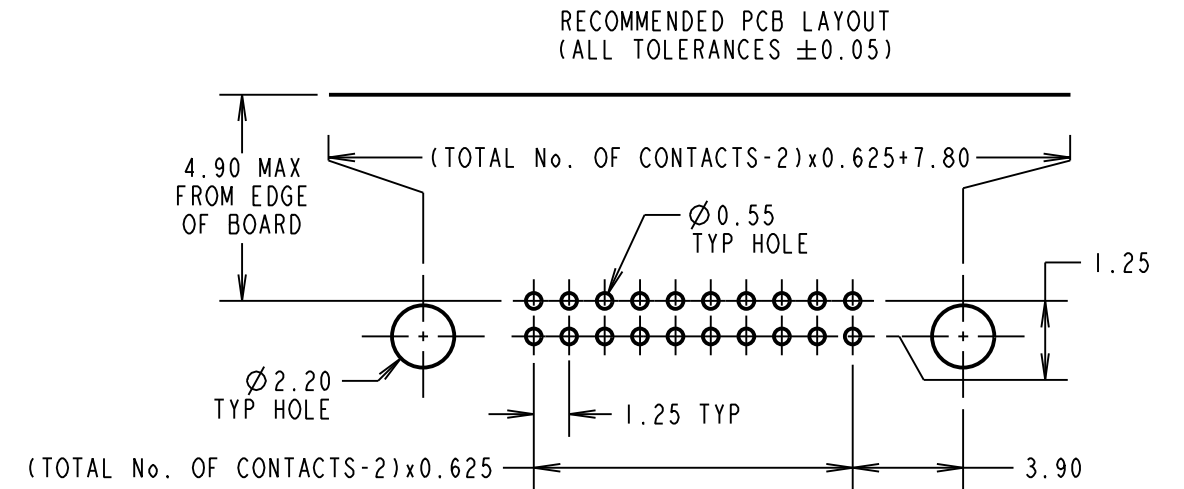
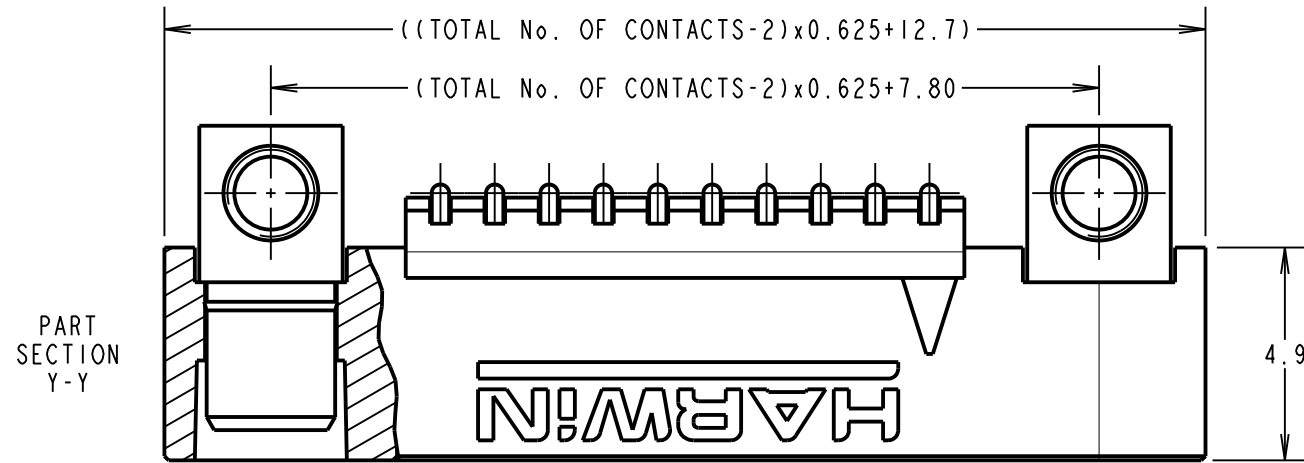

PRODUCT CODE:
G125-MH1XX05M4P

TOTAL No. OF CONTACTS: 06, 10, 12, 16, 20, 26, 34 & 50.

CONNECTOR AND PCB LAYOUT DETAILS ONLY.
SEE SHEET 4 FOR TAPE STRIP DETAILS.

- NOTES:
- FOR MATERIALS, FINISH AND SPECIFICATION SEE GECKO SERIES CONNECTORS SPECIFICATION SUMMARY SHEET OR COMPONENT SPECIFICATION G125XX (LATEST ISSUE) FOR FULL SPECIFICATION.
 - DRAWING SHOWS CONNECTOR WITH 20 CONTACTS.

| | | | |
|----------------|------|------------|--------|
| RTP | 1 | 20.02.20 | 30013 |
| NAME | ISS. | DATE | C/NOTE |
| APPROVED: | | R.PORTLOCK | |
| CHECKED: | | M.RUDKIN | |
| DRAWN: | | R.PORTLOCK | |
| CUSTOMER REF.: | | | |
| ASSEMBLY DRG: | | | |



HARWIN

www.harwin.com
technical@harwin.com

THIS DRAWING AND ANY INFORMATION OR DESCRIPTIVE MATTER SET OUT HEREON ARE CONFIDENTIAL AND COPYRIGHT PROPERTY OF THE HARWIN GROUP AND MUST NOT BE DISCLOSED, LOANED, COPIED OR USED FOR MANUFACTURING, TENDERING OR FOR ANY OTHER PURPOSE WITHOUT THEIR WRITTEN PERMISSION.

TOLERANCES
X. = ± 1 mm
X.X = ± 0.50 mm
X.XX = ± 0.20 mm
X.XXX = ± 0.01 mm
ANGLES = $\pm 5^\circ$
UNLESS STATED

MATERIAL:
SEE ABOVE

FINISH: SEE ABOVE

S/AREA: mm²

TITLE: GECKO-SL HORIZONTAL PC-TAIL MALE CONNECTOR ASSEMBLY

DRAWING NUMBER:
G125-MH1XX05M4P

SHT 3 OF 4

Customer Information Sheet

DRAWING No.: G125-MH1XX05M4P

IF IN DOUBT - ASK

©

NOT TO SCALE

THIRD ANGLE PROJECTION

ALL DIMENSIONS IN mm

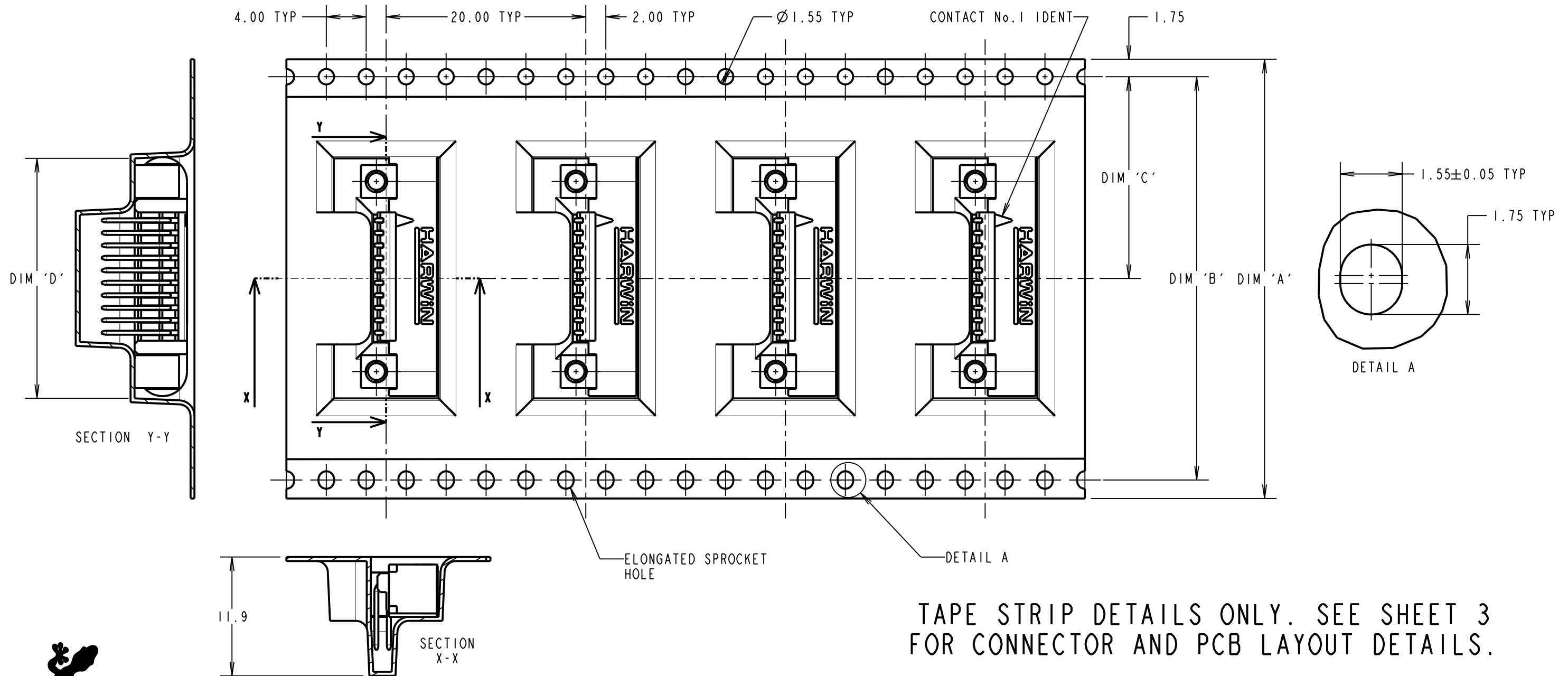

TAPE STRIP DETAILS ONLY. SEE SHEET 3 FOR CONNECTOR AND PCB LAYOUT DETAILS.



PRODUCT CODE:
G125-MH1XX05M4P
 TOTAL No. OF CONTACTS:
 06, 10, 12, 16, 20, 26, 34 & 50.

| PART No. | DIM 'A' | DIM 'B' | DIM 'C' | DIM 'D' |
|-----------------|----------|---------|------------|------------|
| G125-MH10605M4P | | | | 15.30±0.15 |
| G125-MH11005M4P | 32.0±0.3 | 28.40 | 14.20 | 17.80±0.15 |
| G125-MH11205M4P | | | | 19.05±0.15 |
| G125-MH11605M4P | | | | 21.55±0.15 |
| G125-MH12005M4P | 44.0±0.3 | 40.40 | 20.20±0.15 | 24.05±0.15 |
| G125-MH12605M4P | | | | 27.80±0.15 |
| G125-MH13405M4P | | | | 32.80±0.15 |
| G125-MH15005M4P | 56.0±0.3 | 52.40 | 26.20±0.15 | 42.80±0.15 |

| | | | |
|----------------------|------|----------|--------|
| RTP | 1 | 20.02.20 | 30013 |
| NAME | ISS. | DATE | C/NOTE |
| APPROVED: R.PORTLOCK | | | |
| CHECKED: M.RUDKIN | | | |
| DRAWN: R.PORTLOCK | | | |
| CUSTOMER REF.: | | | |
| ASSEMBLY DRG: | | | |

NOTES CONT.:
 3. COMPONENTS ARE ORIENTED IN TAPE POCKETS AS SHOWN.
 4. COMPONENTS ARE SUPPLIED IN STRIPS OF TAPE. SUPPLIED QUANTITY MAY CONSIST OF MORE THAN ONE STRIP. STRIP LENGTH MAY VARY.
 5. LARGE QUANTITIES MAY BE SHIPPED ON A REEL AND MAY NOT HAVE A LEADER.

HARWIN
 www.harwin.com
 technical@harwin.com

THIS DRAWING AND ANY INFORMATION OR DESCRIPTIVE MATTER SET OUT HEREON ARE CONFIDENTIAL AND COPYRIGHT PROPERTY OF THE HARWIN GROUP AND MUST NOT BE DISCLOSED, LOANED, COPIED OR USED FOR MANUFACTURING, TENDERING OR FOR ANY OTHER PURPOSE WITHOUT THEIR WRITTEN PERMISSION.

TOLERANCES
 X. = ±1mm
 X.X = ±0.50mm
 X.XX = ±0.20mm
 X.XXX = ±0.01mm
 ANGLES = ±5°
 UNLESS STATED

MATERIAL:
 SEE SHEET 3
 FINISH: SEE SHEET 3
 S/AREA: mm²

TITLE: GECKO-SL HORIZONTAL PC-TAIL MALE CONNECTOR ASSEMBLY
 DRAWING NUMBER:
G125-MH1XX05M4P
 SHT 4 OF 4

Customer Information Sheet

DRAWING No.: G125-SERIES COMPONENT SPECIFICATION

IF IN DOUBT - ASK

©

NOT TO SCALE

THIRD ANGLE PROJECTION

ALL DIMENSIONS IN mm

SPECIFICATIONS:

MATERIALS:

MOULDING, PICK & PLACE CAP:
POLYAMIDE, PA4T-GF30 FR(40) UL94V-0,
HALOGEN FREE, FREE OF RED PHOSPHORUS

CONTACTS:

SIGNAL CONTACTS:
MALE PC-TAIL/SMT = PHOSPHOR BRONZE
MALE CRIMP = BRASS
ALL FEMALE CONTACTS = BERYLLIUM COPPER
POWER CONTACTS:
ALL CONTACTS = BERYLLIUM COPPER

LOCKING HARDWARE:

LATCHES: COPPER NICKEL TIN ALLOY
SCREW LOCK: STAINLESS STEEL

BACK POTTING COMPOUND (CABLE ASSEMBLIES ONLY):
STYCAST 2651 MM BACK POTTING WITH CATALYST 9

FINISH:

ALL SIGNAL CONTACTS:
0.2-0.3µm GOLD OVER NICKEL
ALL POWER CONTACTS:
0.76-1.00µm GOLD OVER 1.50-2.50µm NICKEL
AND COPPER FLASH
LATCHES:
3.0µm 100% TIN OVER NICKEL

MECHANICAL:

DURABILITY = 1000 OPERATIONS
RETENTION IN HOUSING (ALL CONTACTS) = 6.0N MIN
SIGNAL CONTACTS:
INSERTION FORCE = 2.8N MAX
WITHDRAWAL FORCE = 0.2N MIN
POWER CONTACTS:
INSERTION FORCE = 7.0N MAX
WITHDRAWAL FORCE = 0.2N MIN
SCREW-LOK:
RETENTION IN HOUSING = 20.0N MIN
LATCHES:
RETENTION IN HOUSING = 4.0N MIN

ENVIRONMENTAL:

CLASSIFICATION: 65/150/56 DAYS AT 93% RH

TEMPERATURE RANGE:

* EIA-364-32 : 2000 TEST CONDITION IV, DWELL
30mins, 5 CYCLES -65°C TO +150°C

MECHANICAL:

VIBRATION AND SHOCK:

* EIA-364-28D : 1999: TEST CONDITION IV: VIBRATION SEVERITY:
10Hz TO 2000Hz, 1.5mm, 198mm/s² (20G). DURATION 2Hr
* EIA-364-28D : 1999: TEST CONDITION IV: VIBRATION SEVERITY:
10Hz TO 2000Hz, 1.5mm, 198mm/s² (20G). DURATION 2Hr
* EIA-364-27B : 1996: TEST CONDITION E SHOCK SEVERITY: 981mm/s²
(100G) FOR 6ms IN Z AXIS, 490mm/s² (50G) FOR 11ms IN X & Y AXIS.
* EIA-364-01A : 2000: ACCELERATION: 490mm/s² (50G)
* BUMP SEVERITY: 390mm/s² (40G), 4000±10 BUMPS
* TESTED WITH LATCHED CONNECTORS

ELECTRICAL:

CURRENT RATING:

SIGNAL CONTACTS:

EIA-364-70A : 1998: INDIVIDUAL CONTACT IN ISOLATION AT 25°C = 2.8A MAX
EIA-364-70A : 1998: ALL CONTACTS SIMULTANEOUSLY AT 25°C = 2.0A MAX

POWER CONTACTS:

EIA-364-70A : 1998: PER CONTACT, THROUGH ALL CONTACTS = 10A MAX

CONTACT RESISTANCE:

EIA-364-06C : 2006: INITIAL CONTACT RESISTANCE = 20mΩ MAX
EIA-364-06C : 2006: CONTACT RESISTANCE AFTER CONDITIONING = 25mΩ MAX

VOLTAGE PROOF:

EIA-364-20C : 2004: SEA LEVEL (1013mbar) = 600V DC/AC PEAK
EIA-364-20C : 2004: ALTITUDE LEVEL (44mbar, 21,336m/70,000ft) = 350V DC/AC PEAK

WORKING VOLTAGE:

AT SEA LEVEL (1006mbar) = 450V DC/AC PEAK
AT ALTITUDE (44mbar, 21,336m/70,000ft) = 250V DC/AC PEAK

INSULATION RESISTANCE:

EIA-364-21C : 2000: INSULATION RESISTANCE (INITIAL)
= 10GΩ MIN AT 500V DC
EIA-364-21C : 2000: INSULATION RESISTANCE (AFTER CONDITIONING)
= >1GΩ MIN AT 500V DC

FOR FULL COMPONENT SPECIFICATION SEE C125XX (LATEST ISSUE).



PATENTED TECHNOLOGY

HARWIN

www.harwin.com
technical@harwin.com

THIS DRAWING AND ANY INFORMATION OR DESCRIPTIVE MATTER SET OUT HEREON ARE CONFIDENTIAL AND COPYRIGHT PROPERTY OF THE HARWIN GROUP AND MUST NOT BE DISCLOSED, LOANED, COPIED OR USED FOR MANUFACTURING, TENDERING OR FOR ANY OTHER PURPOSE WITHOUT THEIR WRITTEN PERMISSION.

TOLERANCES

X. = ±1mm
X.X = ±0.50mm
X.XX = ±0.20mm
X.XXX = ±0.01mm
ANGLES = ±5°
UNLESS STATED

MATERIAL:

SEE ABOVE

FINISH:

SEE ABOVE

S/AREA:

mm²

TITLE:

G125 SERIES COMPONENT SPECIFICATION

DRAWING NUMBER:

G125-SERIES CONNECTORS

SHT
1
OF
1

| | | | |
|----------------|------|------------|--------|
| RTP | 5 | 04.10.19 | 22083 |
| NAME | ISS. | DATE | C/NOTE |
| APPROVED: | | R.PORTLOCK | |
| CHECKED: | | S.BENNETT | |
| DRAWN: | | S.FLOWER | |
| CUSTOMER REF.: | | | |
| ASSEMBLY DRG: | | | |

Mouser Electronics

Authorized Distributor

Click to View Pricing, Inventory, Delivery & Lifecycle Information:

[Harwin:](#)

[G125-MH11005M4P](#) [G125-MH11205M4P](#) [G125-MH11605M4P](#) [G125-MH12005M4P](#) [G125-MH12605M4P](#) [G125-MH13405M4P](#) [G125-MH15005M4P](#) [G125-MH10605M4P](#)