



**MICROCHIP**

---

**MiWi™ Demo Kit  
User's Guide**

---

---

**Note the following details of the code protection feature on Microchip devices:**

- Microchip products meet the specification contained in their particular Microchip Data Sheet.
- Microchip believes that its family of products is one of the most secure families of its kind on the market today, when used in the intended manner and under normal conditions.
- There are dishonest and possibly illegal methods used to breach the code protection feature. All of these methods, to our knowledge, require using the Microchip products in a manner outside the operating specifications contained in Microchip's Data Sheets. Most likely, the person doing so is engaged in theft of intellectual property.
- Microchip is willing to work with the customer who is concerned about the integrity of their code.
- Neither Microchip nor any other semiconductor manufacturer can guarantee the security of their code. Code protection does not mean that we are guaranteeing the product as "unbreakable."

Code protection is constantly evolving. We at Microchip are committed to continuously improving the code protection features of our products. Attempts to break Microchip's code protection feature may be a violation of the Digital Millennium Copyright Act. If such acts allow unauthorized access to your software or other copyrighted work, you may have a right to sue for relief under that Act.

---

Information contained in this publication regarding device applications and the like is provided only for your convenience and may be superseded by updates. It is your responsibility to ensure that your application meets with your specifications. MICROCHIP MAKES NO REPRESENTATIONS OR WARRANTIES OF ANY KIND WHETHER EXPRESS OR IMPLIED, WRITTEN OR ORAL, STATUTORY OR OTHERWISE, RELATED TO THE INFORMATION, INCLUDING BUT NOT LIMITED TO ITS CONDITION, QUALITY, PERFORMANCE, MERCHANTABILITY OR FITNESS FOR PURPOSE. Microchip disclaims all liability arising from this information and its use. Use of Microchip devices in life support and/or safety applications is entirely at the buyer's risk, and the buyer agrees to defend, indemnify and hold harmless Microchip from any and all damages, claims, suits, or expenses resulting from such use. No licenses are conveyed, implicitly or otherwise, under any Microchip intellectual property rights.

### Trademarks

The Microchip name and logo, the Microchip logo, dsPIC, FlashFlex, KEELOQ, KEELOQ logo, MPLAB, PIC, PICmicro, PICSTART, PIC<sup>32</sup> logo, rPIC, SST, SST Logo, SuperFlash and UNI/O are registered trademarks of Microchip Technology Incorporated in the U.S.A. and other countries.

FilterLab, Hampshire, HI-TECH C, Linear Active Thermistor, MTP, SEEVAL and The Embedded Control Solutions Company are registered trademarks of Microchip Technology Incorporated in the U.S.A.

Silicon Storage Technology is a registered trademark of Microchip Technology Inc. in other countries.

Analog-for-the-Digital Age, Application Maestro, BodyCom, chipKIT, chipKIT logo, CodeGuard, dsPICDEM, dsPICDEM.net, dsPICworks, dsSPEAK, ECAN, ECONOMONITOR, FanSense, HI-TIDE, In-Circuit Serial Programming, ICSP, Mindi, MiWi, MPASM, MPF, MPLAB Certified logo, MPLIB, MPLINK, mTouch, Omniscient Code Generation, PICC, PICC-18, PICDEM, PICDEM.net, PICkit, PICtail, REAL ICE, rLAB, Select Mode, SQI, Serial Quad I/O, Total Endurance, TSHARC, UniWinDriver, WiperLock, ZENA and Z-Scale are trademarks of Microchip Technology Incorporated in the U.S.A. and other countries.

SQTP is a service mark of Microchip Technology Incorporated in the U.S.A.

GestIC and ULPP are registered trademarks of Microchip Technology Germany II GmbH & Co. & KG, a subsidiary of Microchip Technology Inc., in other countries.

All other trademarks mentioned herein are property of their respective companies.

© 2012, Microchip Technology Incorporated, Printed in the U.S.A., All Rights Reserved.

 Printed on recycled paper.

ISBN: 978-1-62076-575-3

---

---

**QUALITY MANAGEMENT SYSTEM  
CERTIFIED BY DNV  
= ISO/TS 16949 =**

*Microchip received ISO/TS-16949:2009 certification for its worldwide headquarters, design and wafer fabrication facilities in Chandler and Tempe, Arizona; Gresham, Oregon and design centers in California and India. The Company's quality system processes and procedures are for its PIC<sup>®</sup> MCUs and dsPIC<sup>®</sup> DSCs, KEELOQ<sup>®</sup> code hopping devices, Serial EEPROMs, microperipherals, nonvolatile memory and analog products. In addition, Microchip's quality system for the design and manufacture of development systems is ISO 9001:2000 certified.*



---

---

## Table of Contents

---

---

<b>Preface</b> .....	<b>5</b>
<b>Chapter 1. Overview</b>	
1.1 MiWi™ Demo Kit Contents .....	9
1.2 MiWi™ Demo Kit .....	9
<b>Chapter 2. MiWi™ Demo Board</b>	
2.1 MiWi™ Board Layout and Features .....	11
<b>Chapter 3. Getting Started</b>	
3.1 Hardware Requirements .....	15
3.2 Demo Setup .....	15
3.3 Preprogrammed Tutorial Operation .....	15
<b>Appendix A. MiWi™ Demo Board Schematics</b>	
A.1 Introduction .....	19
A.2 MiWi™ Demo Board Schematics .....	19
A.3 MiWi™ Demo Board PCB Layout .....	23
A.4 MiWi™ Demo Board Bill of Materials (BOM) .....	29
<b>Index</b> .....	<b>31</b>
<b>Worldwide Sales and Service</b> .....	<b>32</b>

---

---

**NOTES:**

---

---

## Preface

---

---

### NOTICE TO CUSTOMERS

All documentation becomes dated, and this manual is no exception. Microchip tools and documentation are constantly evolving to meet customer needs, so some actual dialogs and/or tool descriptions may differ from those in this document. Please refer to our web site ([www.microchip.com](http://www.microchip.com)) to obtain the latest documentation available.

Documents are identified with a “DS” number. This number is located on the bottom of each page, in front of the page number. The numbering convention for the DS number is “DSXXXXA”, where “XXXX” is the document number and “A” is the revision level of the document.

For the most up-to-date information on development tools, see the MPLAB® IDE online help. Select the Help menu, and then Topics to open a list of available online help files.

## INTRODUCTION

This chapter contains general information that will be useful to know before using the MiWi™ Demo Kit User's Guide. Items discussed in this chapter include:

- [Document Layout](#)
- [Conventions Used in this Guide](#)
- [Warranty Registration](#)
- [Recommended Reading](#)
- [The Microchip Web Site](#)
- [Development Systems Customer Change Notification Service](#)
- [Customer Support](#)

## DOCUMENT LAYOUT

This user's guide describes how to use the MiWi Demo Kit to evaluate and experiment the Microchip Wireless Solutions. This user's guide consists of the following chapters:

- **Chapter 1. “Overview”** This chapter describes the MiWi Demo Kit and how it works.
- **Chapter 2. “MiWi™ Demo Board”** This chapter details the hardware information of the MiWi Demo Board.
- **Chapter 3. “Getting Started”** This chapter describes what you need to know to start using the MiWi Demo Kit.
- **Appendix A. “MiWi™ Demo Board Schematics”** This appendix illustrates the PCB layout and BOM, and it also includes MiWi Demo Board schematics.

# MiWi™ Demo Kit User's Guide

## CONVENTIONS USED IN THIS GUIDE

This manual uses the following documentation conventions:

### DOCUMENTATION CONVENTIONS

Description	Represents	Examples
<b>Arial font:</b>		
Italic characters	Referenced books	<i>MPLAB® IDE User's Guide</i>
	Emphasized text	...is the <i>only</i> compiler...
Initial caps	A window	the Output window
	A dialog	the Settings dialog
	A menu selection	select Enable Programmer
Quotes	A field name in a window or dialog	"Save project before build"
Underlined, italic text with right angle bracket	A menu path	<u><i>File&gt;Save</i></u>
Bold characters	A dialog button	Click <b>OK</b>
	A tab	Click the <b>Power</b> tab
Text in angle brackets < >	A key on the keyboard	Press <Enter>, <F1>
<b>Courier New font:</b>		
Plain Courier New	Sample source code	#define START
	Filenames	autoexec.bat
	File paths	C:\mcc18\h
	Keywords	_asm, _endasm, static
	Command-line options	-Opa+, -Opa-
	Bit values	0, 1
	Constants (in source code)	0xFF, 'A'
<i>Italic Courier New</i>	A variable argument	<i>file.o</i> , where file can be any valid filename
Square brackets [ ]	Optional arguments	mcc18 [options] file [options]
Curly brackets and pipe character: {   }	Choice of mutually exclusive arguments; an OR selection	errorlevel {0 1}
Ellipses...	Replaces repeated text	var_name [, var_name...]
	Represents code supplied by user	void main (void) { ... }

## WARRANTY REGISTRATION

Please complete the enclosed Warranty Registration Card and mail it promptly. Sending in the Warranty Registration Card entitles users to receive new product updates. Interim software releases are available at the Microchip web site.

## RECOMMENDED READING

This user's guide describes how to use the ZENA Wireless Adapter. The following Microchip documents are available from the Microchip web site (<http://www.microchip.com>), and are recommended as supplemental reference resources.

- *"MRF24J40MA 2.4 GHz IEEE Std. 802.15.4 RF Transceiver Module"* (DS70329)
- *"MRF89XAM8A Data Sheet 868 MHz Ultra-Low Power Sub-GHz Transceiver Module"* (DS70651)
- *"MRF89XAM9A Data Sheet 915 MHz Ultra-Low Power Sub-GHz Transceiver Module"* (DS75017)
- *"PIC18F46J50 USB Microcontroller Data Sheet"* (DS39931)
- *"2K SPI Bus Serial EEPROM with EUI-48TM Node Identity Data Sheet"* (DS22123)
- *"1 Mbit SPI Serial Flash SST25VF010A"* (S725081)
- *"MCP9700A/01A - Low Power Linear Active Thermistor ICs"* (DS21942)

## THE MICROCHIP WEB SITE

Microchip provides online support through our web site at <http://www.microchip.com>. This web site makes files and information easily available to customers. Accessible by most Internet browsers, the web site contains the following information:

- **Product Support** – Data sheets and errata, application notes and sample programs, design resources, user's guides and hardware support documents, latest software releases and archived software
- **General Technical Support** – Frequently Asked Questions (FAQs), technical support requests, online discussion groups, Microchip consultant program member listings
- **Business of Microchip** – Product selector and ordering guides, latest Microchip press releases, listings of seminars and events; and listings of Microchip sales offices, distributors and factory representatives

## DEVELOPMENT SYSTEMS CUSTOMER CHANGE NOTIFICATION SERVICE

Microchip's customer notification service helps keep customers current on Microchip products. Subscribers will receive e-mail notification whenever there are changes, updates, revisions or errata related to a specified product family or development tool of interest.

To register, access the Microchip web site at <http://www.microchip.com>, click **Customer Change Notification** and follow the registration instructions.

The Development Systems product group categories are:

- **Compilers** – The latest information on Microchip C compilers and other language tools. These include the MPLAB C18 and MPLAB C30 C compilers; MPASM™ and MPLAB ASM30 assemblers; MPLINK™ and MPLAB LINK30 object linkers; and MPLIB™ and MPLAB LIB30 object librarians.
- **Emulators** – The latest information on Microchip in-circuit emulators. This includes the MPLAB ICE 2000 and MPLAB ICE 4000.
- **In-Circuit Debuggers** – The latest information on the Microchip in-circuit debugger, MPLAB ICD 2.
- **MPLAB IDE** – The latest information on Microchip MPLAB IDE, the Windows® Integrated Development Environment for development systems tools. This list is focused on the MPLAB IDE, MPLAB SIM simulator, MPLAB IDE Project Manager and general editing and debugging features.
- **Programmers** – The latest information on Microchip programmers. These include the MPLAB PM3 and PRO MATE® II device programmers and the PICSTART® Plus and PICKit™ 1 development programmers.

## CUSTOMER SUPPORT

Several channels are available to assist the users of Microchip products:

- Distributor or Representative
- Local Sales Office
- Field Application Engineer (FAE)
- Technical Support

Customers should contact their distributor, representative, or FAE for support. Local sales offices are also available to help customers. A list of sales offices and locations is included in the back of this document.

Technical support is available through our web site at <http://support.microchip.com>.

## DOCUMENT REVISION HISTORY

### Revision A (September 2012)

This is the initial released version of the document.



---

---

## Chapter 1. Overview

---

---

This chapter introduces the MiWi™ Demo Kit features and its requirements. The topic covered includes:

- [MiWi™ Demo Kit Contents](#)
- [MiWi™ Demo Kit](#)

### 1.1 MiWi™ DEMO KIT CONTENTS

Based on the frequency of operation selected, the MiWi Demo Kit contains any one of the following items:

- Two MiWi Demo Boards with PIC18F46J50 XLP Microcontroller with MRF24J40 MA Module
- Two MiWi Demo Boards with PIC18F46J50 XLP Microcontroller with MRF89XAM8A Module
- Two MiWi Demo Boards with PIC18F46J50 XLP Microcontroller with MRF89XAM9A Module

### 1.2 MiWi™ DEMO KIT

The MiWi Demo Kit enables developers to evaluate and experiment with 2.4 GHz, 868 MHz and 915 MHz RF solutions from Microchip. The MiWi Demo Kit contains two hardware nodes (MiWi Demo Boards) which can be used to create a simple two node MiWi wireless network. More hardware nodes to the same network can be added by purchasing additional MiWi Demo Kits or individual components.

The MiWi Demo Kit is preprogrammed with a wireless demo program that enables users to setup a MiWi network easily. For more information on running the preprogrammed demo program and extending the network refer to [Chapter 3. "Getting Started"](#). The Microchip wireless stacks and additional application demo source codes can be downloaded from the Microchip web site <http://www.microchip.com/wireless>.

# MiWi™ Demo Kit User's Guide

---

NOTES:

## Chapter 2. MiWi™ Demo Board

This chapter describes the MiWi Demo Board hardware and the topic covers [MiWi™ Board Layout and Features](#).

### 2.1 MiWi™ BOARD LAYOUT AND FEATURES

This section describes the MiWi Demo Board hardware, which also features key components shown in [Figure 2-1](#) and [Figure 2-2](#).

**FIGURE 2-1: MiWi™ DEMO BOARD (FRONT VIEW)**

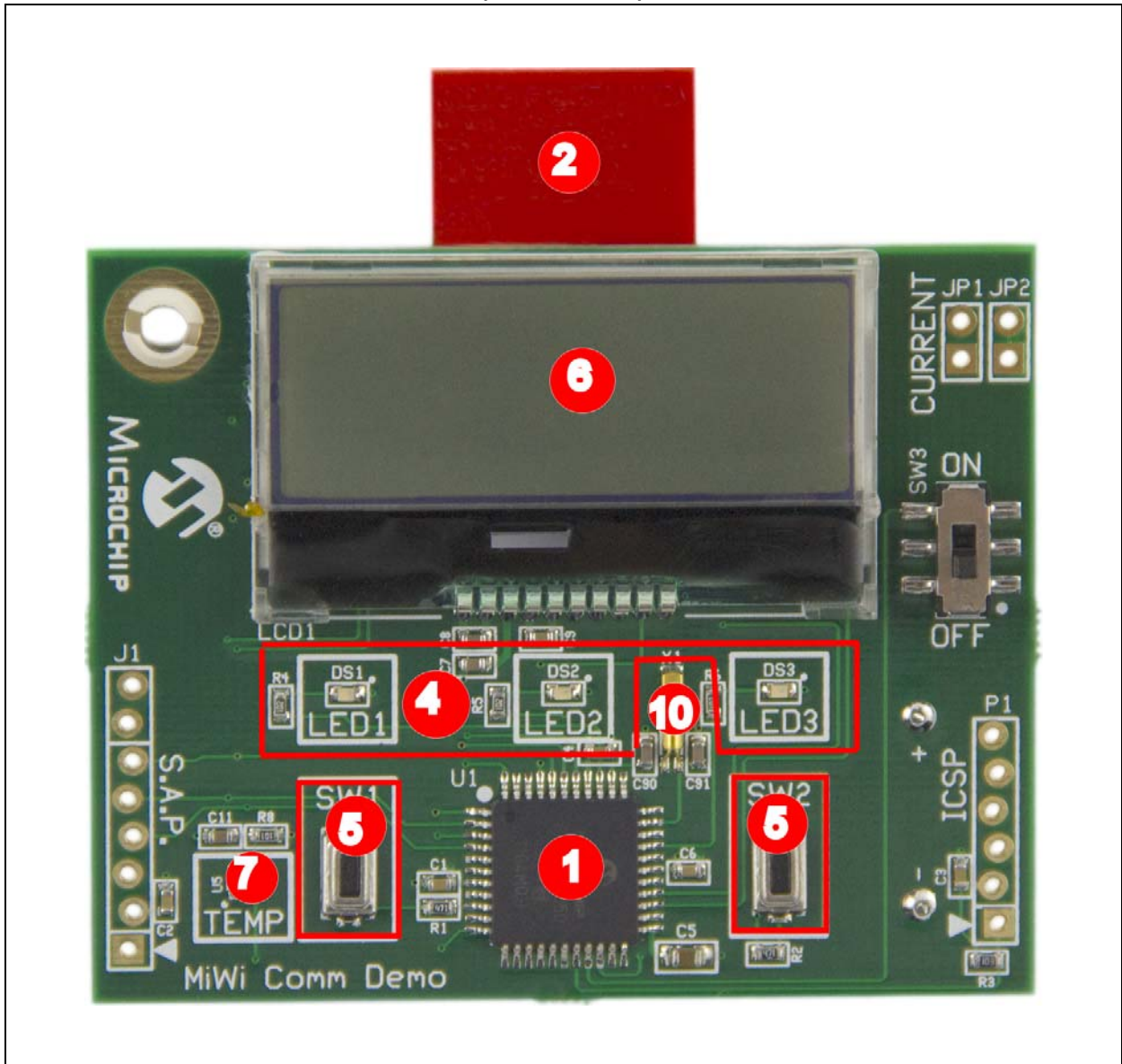

# MiWi™ Demo Kit User's Guide

FIGURE 2-2: MiWi™ DEMO BOARD (REAR VIEW)

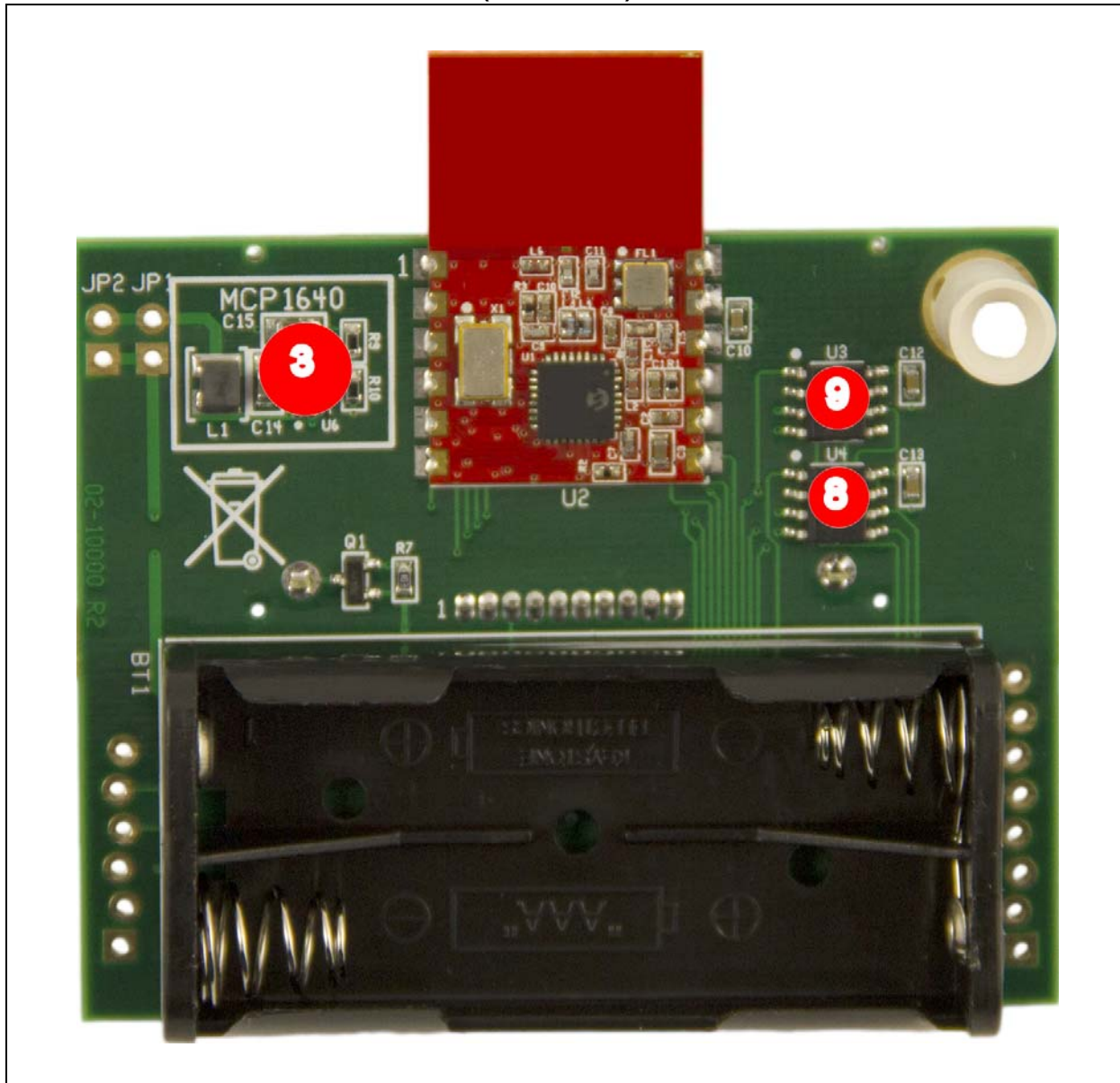

This MiWi Demo board includes these key features, as indicated in the [Figure 2-1](#) and [Figure 2-2](#).

1. PIC18F46J50 8-bit XLP microcontroller
2. MRF24J40MA RF Transceiver Module or MRF89XAM8A RF Transceiver Module or MRF89XAM9A RF Transceiver Module
3. +3.3V Boost Regulator (MCP1640)
4. Three status indicator LEDs (Red, Yellow and Green)
5. Two push-button switches (SW1 and SW2) for user input
6. 2 X 16 LCD Character Display
7. MCP9700 Temperature Sensor
8. 2K SPI EEPROM with a unique MAC Address
9. 1 Mbit SPI Serial Flash
10. 32 KHz Crystal for Sleep Mode

Some of main blocks defined on the board are explained in detail below:

## 2.1.1 PIC18F46J50 Microcontroller

PIC18F46J50 microcontroller is an 8-bit XLP 44-pin microcontroller with 64K program memory.

## 2.1.2 RF Transceiver Module

MiWi Demo board supports MRF24J40MA, MRF89XAM8A, MRF89XAM9A RF transceiver modules. It has dedicated SPI Interface and interrupt lines between the microcontroller and the RF transceiver module.

## 2.1.3 Status Indicator LEDs

To indicate the status the MiWi Demo board has three LEDs: LED1(green), LED2 (yellow), and LED3 (red).

## 2.1.4 Push Buttons

MiWi Demo board contains two push buttons SW1 and SW2. These push buttons are assigned to the individual interrupt lines of the microcontroller. The user software must enable Port B pull-ups of the microcontroller before evaluating the push button state.

[Example 2-1](#) provides a possible solution to evaluate the state of SW1 push button.

### EXAMPLE 2-1: CODE EXAMPLE FOR EVALUATING THE STATE OF SW1

```
// Initialize RB1 - SW1
TRISBbits.TRISB2 = 1;// RB1 is an input
ANCON1 = ANCON1 | 0x04;// RB1 is a digital pin
/*
User Code
*/
//Evaluating RB1
INTCON2bits.RBPU = 0;// Enable PORT B pull-ups for switches
If (PORTBbits.RB1 = 0 )// RB1 pushed
{
/*
RB1/SW1 push button code
*/
}
INTCON2bits.RBPU = 1;//PORTB pull-ups disabled
```

## 2.1.5 LCD Character Display

The LCD supports power saving modes. The LCD has a backlight display which can be turned on or off based on the power consumption and it supports 32 characters in two lines (16 characters in each line). It uses shared SPI interface (with SPI EEPROM and SPI Serial Flash) to communicate with the microcontroller.

## 2.1.6 Temperature Sensor

The temperature sensor (MCP9700A) is a low-power Linear Active Thermistor IC. To minimize power consumption, the sensor is powered from a port pin. After powering up, the sensor output can be measured after a minute. The internal AD converter of the microcontroller can be used to measure the temperature value.

## 2.1.7 EEPROM with MAC Address

The Serial EEPROM is a low-power, Microchip 25LC256 256K SPI Bus Serial EEPROM, it uses shared SPI interface with SPI Serial Flash and LCD.

## 2.1.8 SPI Serial Flash

MiWi Demo board features a 1Mb SPI Serial Flash for storing and retrieving network or any application specific information. The SPI Serial Flash and Serial EEPROM share the SPI bus and each has its own active low-chip select.

## 2.1.9 Power Supply

The MiWi Demo board uses two AAA batteries for power supply. Current consumption for the entire board can also be measured at JP1 and JP2 without disturbing it.

## 2.1.10 +3.3V Boost Regulator

The MCP1640 is a compact, high efficiency boost regulator. It ensures that the voltage requirements for the RF transceivers are met throughout the lifetime of the battery.

---

---

## Chapter 3. Getting Started

---

---

This chapter is a self paced tutorial to use the MiWi™ Demo Board. It explains in detail how to run the preprogrammed demo. The source code for the demo is available along with the MiWi stack (latest version of Microchip Applications library is available at <http://www.microchip.com/MAL>). After unzipping the latest version of MiWi stack, the default location for MiWi Demo Kit Out of Box Demo is "C:\Microchip Solutions\MiWi DE Demo\MiWi Demo Kit\".

For more information about MiWi stack, refer to [http:// www.microchip.com/MiWi](http://www.microchip.com/MiWi).

Topics covered include:

- [Hardware Requirements](#)
- [Demo Setup](#)
- [Preprogrammed Tutorial Operation](#)

### 3.1 HARDWARE REQUIREMENTS

The following hardware is required to run the preprogrammed demo application:

- Two MiWi Demo Boards
- Four AAA batteries for powering up the boards

### 3.2 DEMO SETUP

The MiWi Demo Board comes with a preprogrammed Demo Board. Follow these steps to set up the demo:

1. Plug in two AAA batteries on each MiWi Demo Board.
2. To power up the board, move SW3 switch from "OFF" position to the "ON" position. On powering, a splash screen will be displayed on the LCD screen.

### 3.3 PREPROGRAMMED TUTORIAL OPERATION

1. On powering the boards, the following splash screen message will be displayed on the LCD screen for 2 seconds.

"Microchip  
MiWi Demo Board"

2. The display changes to channel selection screen. Choose the channel to setup the network.

"SW1: <Sel Ch: 26>  
SW2: Chnge Chnl"

# MiWi™ Demo Kit User's Guide

---

Press SW1 push button to select channel 26 as the operating channel or press SW2 push button to choose a different channel. For MRF24J40 Channel 11 through channel 26 are available. Using the push buttons on the board, the user can choose operating channel from channel 11 through channel 26. For MRF89XA channel 0 through channel 31 are available.

**Note:** Ensure that you select same operating channel on both the MiWi Demo Boards to enable connection with each other.

3. The LCD screen displays network setup options:

“SW1: Create Ntwk

SW2: Join Ntwk”

4. Press SW1 push button on one of the boards to create a MiWi network (PAN Coordinator) with a random PANID. After the network is created, the board will notify the user that the network is created successfully, and then display the node information such as PAN ID, Channel and Address until a node joins.

“PANID: 1234 Ch: 26

Address: 0000”

5. Press SW2 push button on the second board to join a MiWi network. The board performs a scan of nearby networks and allows the user to choose the network to join to.

“SW1: < PANID:1234>

SW2: Additional”

6. Press SW1 push button on the second board after choosing the network (PANID) to connect.

**Note:** If more than one node from the same network (PANID) has responded with a beacon, the user can select the node to join by using the network short address information printed on the LCD. Use SW1 and SW2 to choose the node to establish connection with in a network similar to PANID.

7. After the second board is joined the network, the user has the option to run any one of the these demo applications: Range Demo, Temp Demo, Node Info. The LCD screen displays this message.

“SW1: Range Demo

SW2: Other Apps”

The current Out of Box demo for MiWi Demo Kit supports all the three Range Demo, Temp Demo and Node Info applications.

- a) Range Demo is used to demonstrate the range of Microchip's MRF24J40MA and MRF89XA transceiver. It performs a range test by transmitting a packet to the remote node and displaying the Received Signal Strength Indication (RSSI) value on the LCD Display. The display will show this RSSI value after each packet is received and will notify the user the strength of the signal such as, high, medium, low, or out of range.
- b) The Temp Demo uses on-board Microchip's MCP9700A temperature sensor (Low-Power Linear Active Thermistor IC). This demo measures the temperature and displays its local temperature information in C (Celsius) and F (Fahrenheit) on the display and broadcast its reading to other nodes listening. If other nodes are connected it will then cycle through each remote node's reading.



- c) In the node Info, the node's PANID and Address information will be displayed on the LCD screen.

"PANID: 1234 Ch: 26

Address: 0000"

Figure 3-1 illustrates the preprogrammed tutorial operation.

**FIGURE 3-1: PREPROGRAMMED TUTORIAL OPERATION**

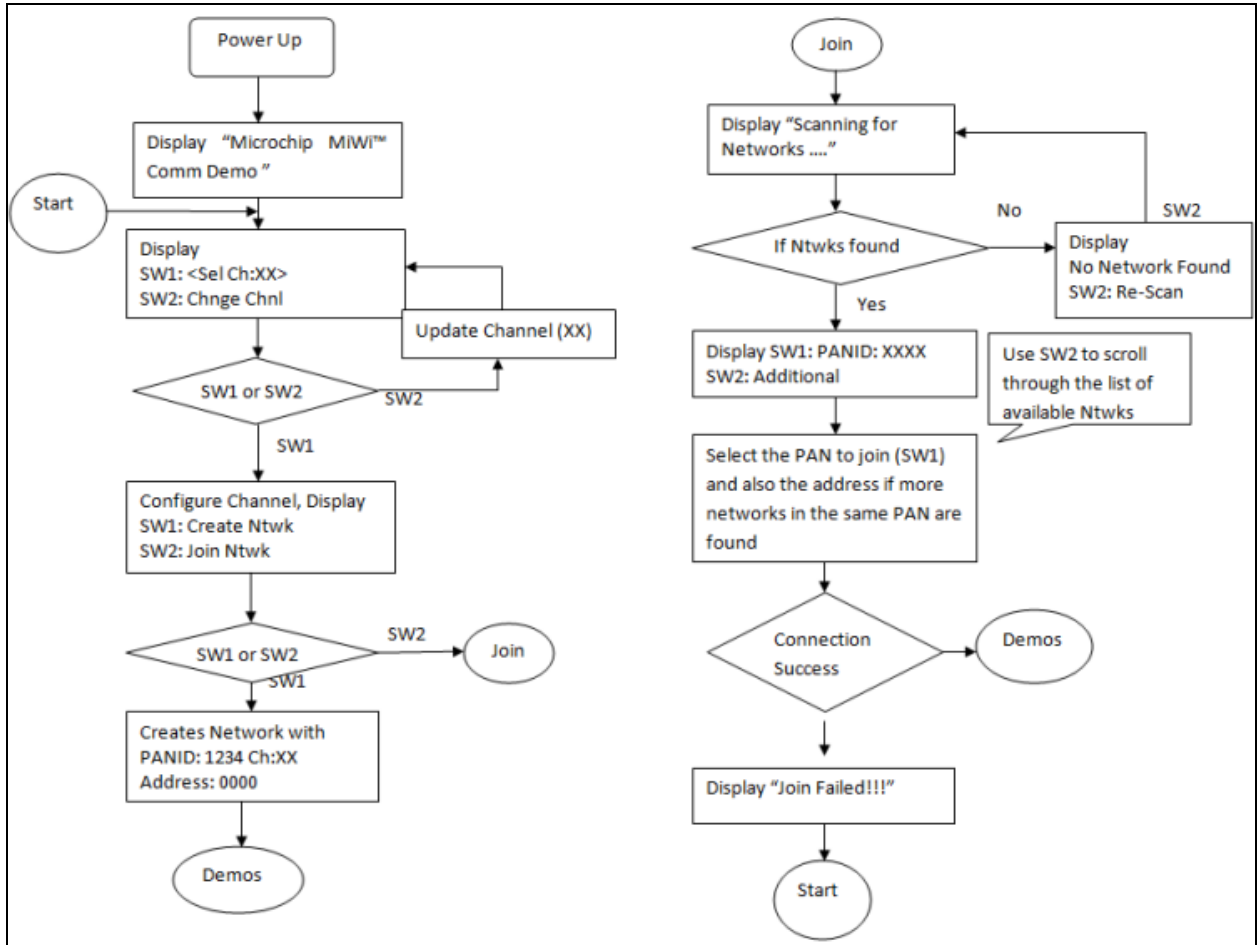

# MiWi™ Demo Kit User's Guide

---

NOTES:

---

---

## **Appendix A. MiWi™ Demo Board Schematics**

---

---

### **A.1 INTRODUCTION**

This appendix includes:

- [MiWi™ Demo Board Schematics](#)
- [MiWi™ Demo Board PCB Layout](#)
- [MiWi™ Demo Board Bill of Materials \(BOM\)](#)

### **A.2 MiWi™ DEMO BOARD SCHEMATICS**

[Figure A-1](#), [Figure A-2](#) and [Figure A-3](#) illustrate the MiWi Demo Board schematics.

FIGURE A-1: MiWi™ DEMO BOARD SCHEMATICS 1 OF 3

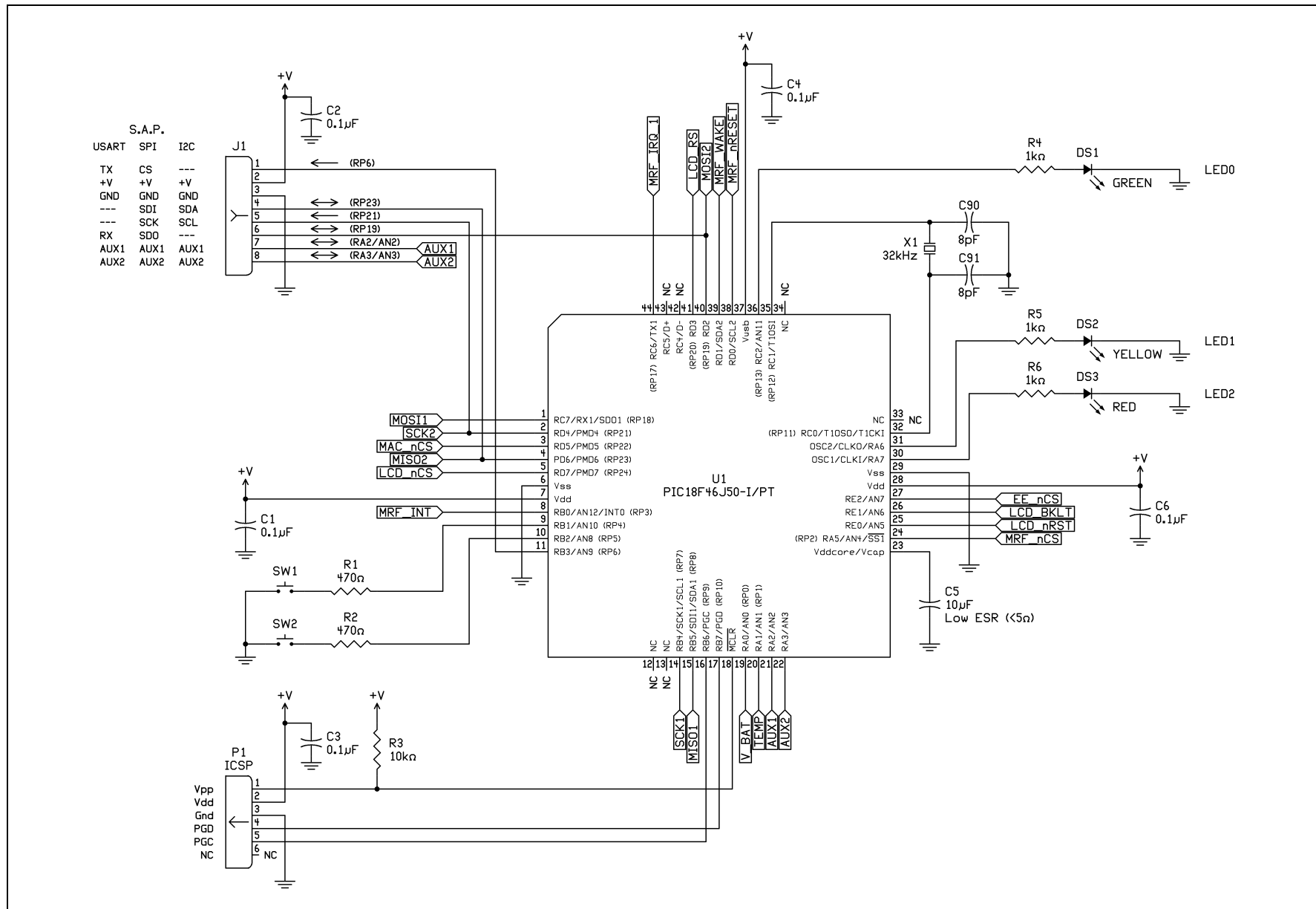





## A.3 MiWi™ DEMO BOARD PCB LAYOUT

The MiWi Demo PCB is a 4-layer, high temperature FR4, 0.062 inch, plated through hole construction. [Figure A-4](#) through [Figure A-9](#) illustrate the PCB layers.

**FIGURE A-4: PCB TOP SILKSCREEN**

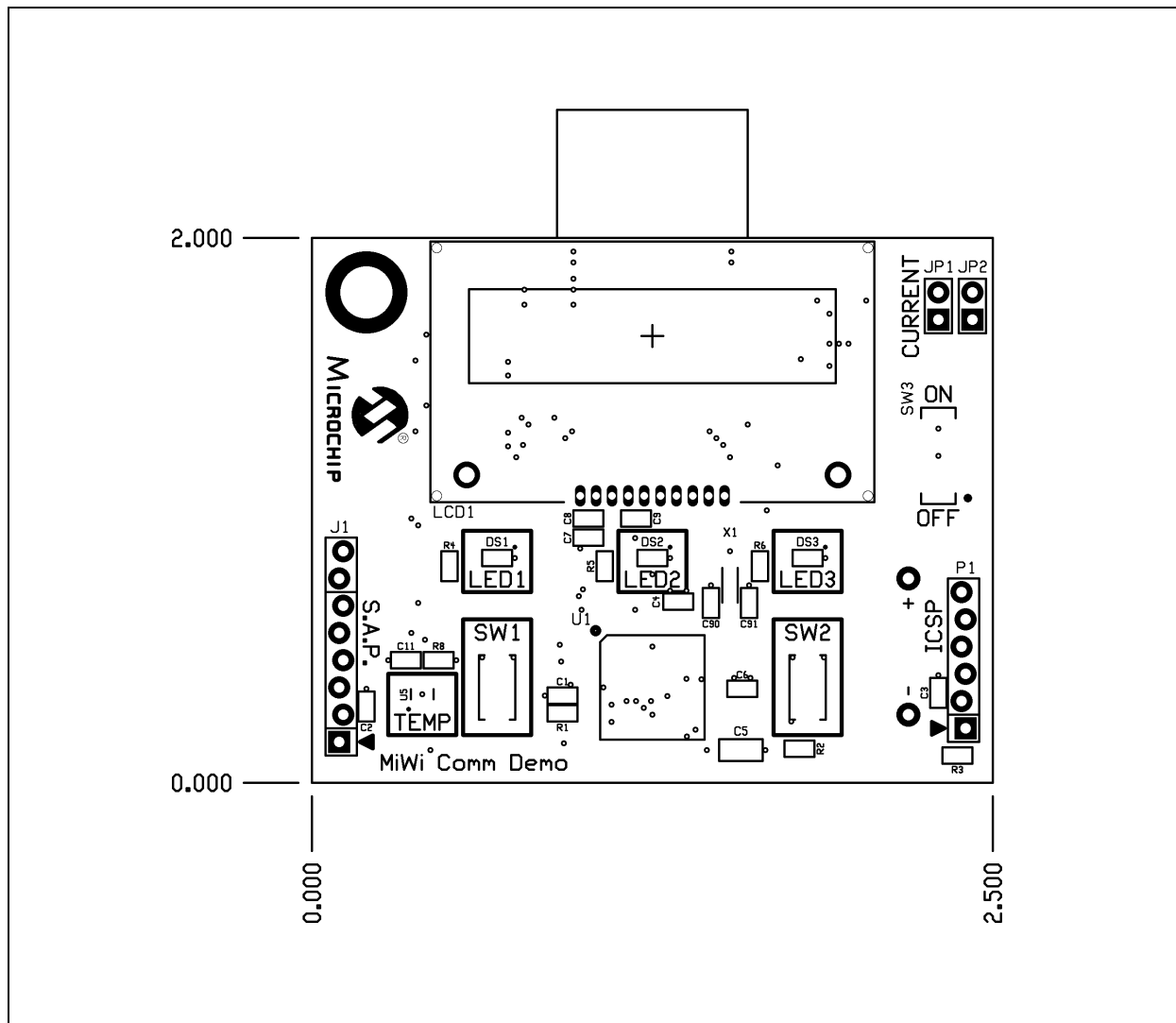

# MiWi™ Demo Kit User's Guide

FIGURE A-5: PCB TOP COPPER

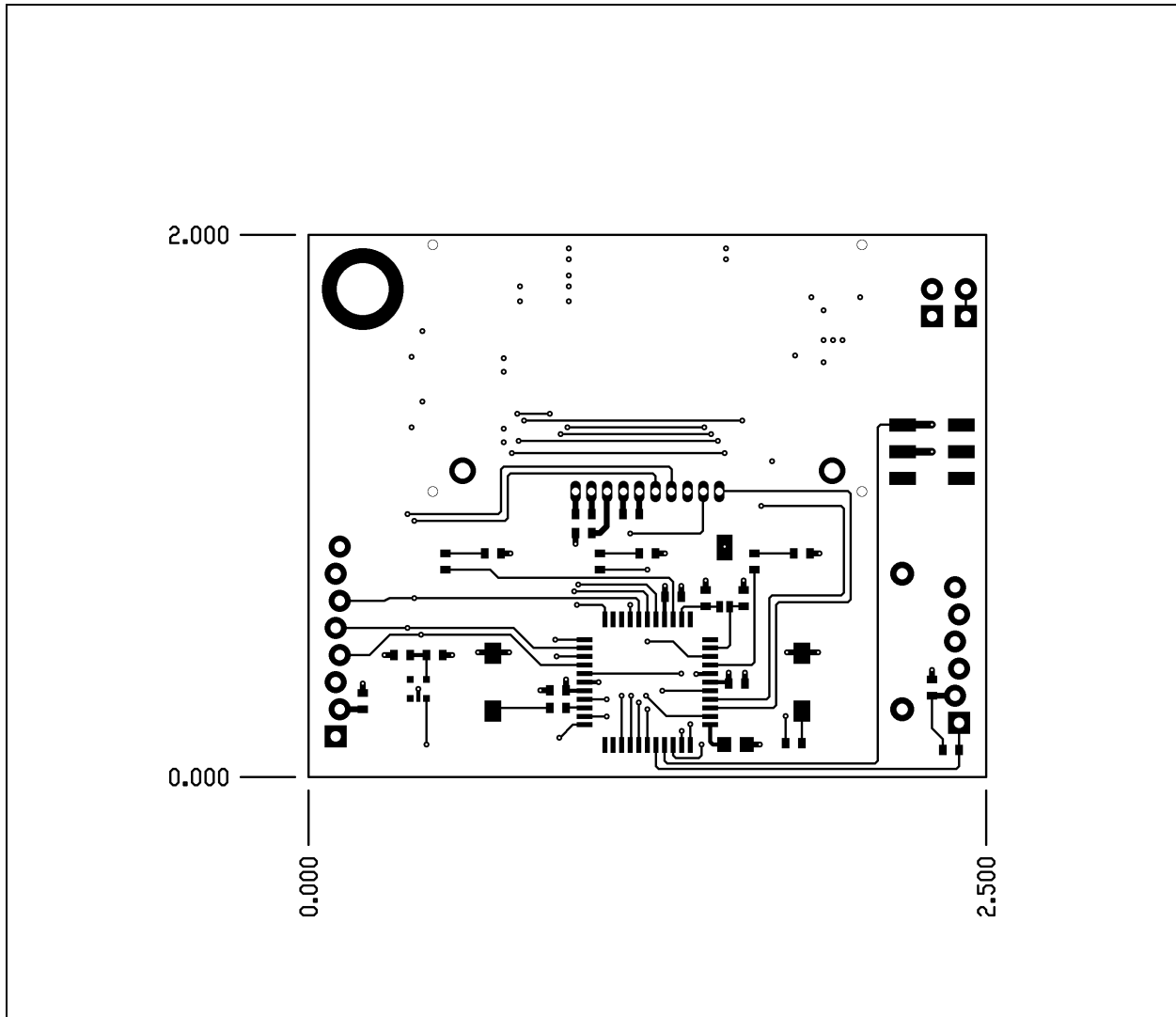





# MiWi™ Demo Kit User's Guide

FIGURE A-7: PCB BOTTOM COPPER

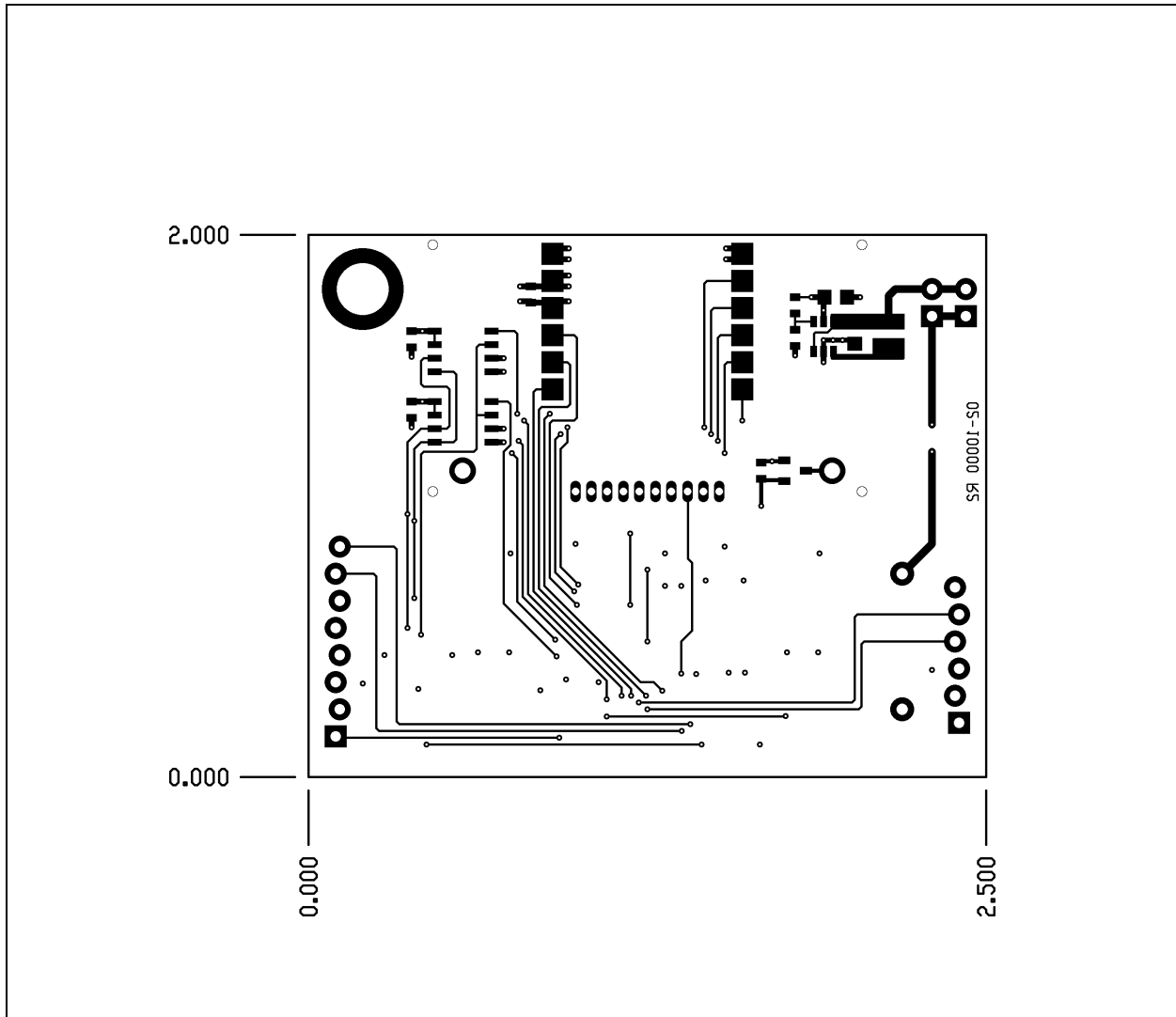

FIGURE A-8: PCB INNER LAYER 2 POWER

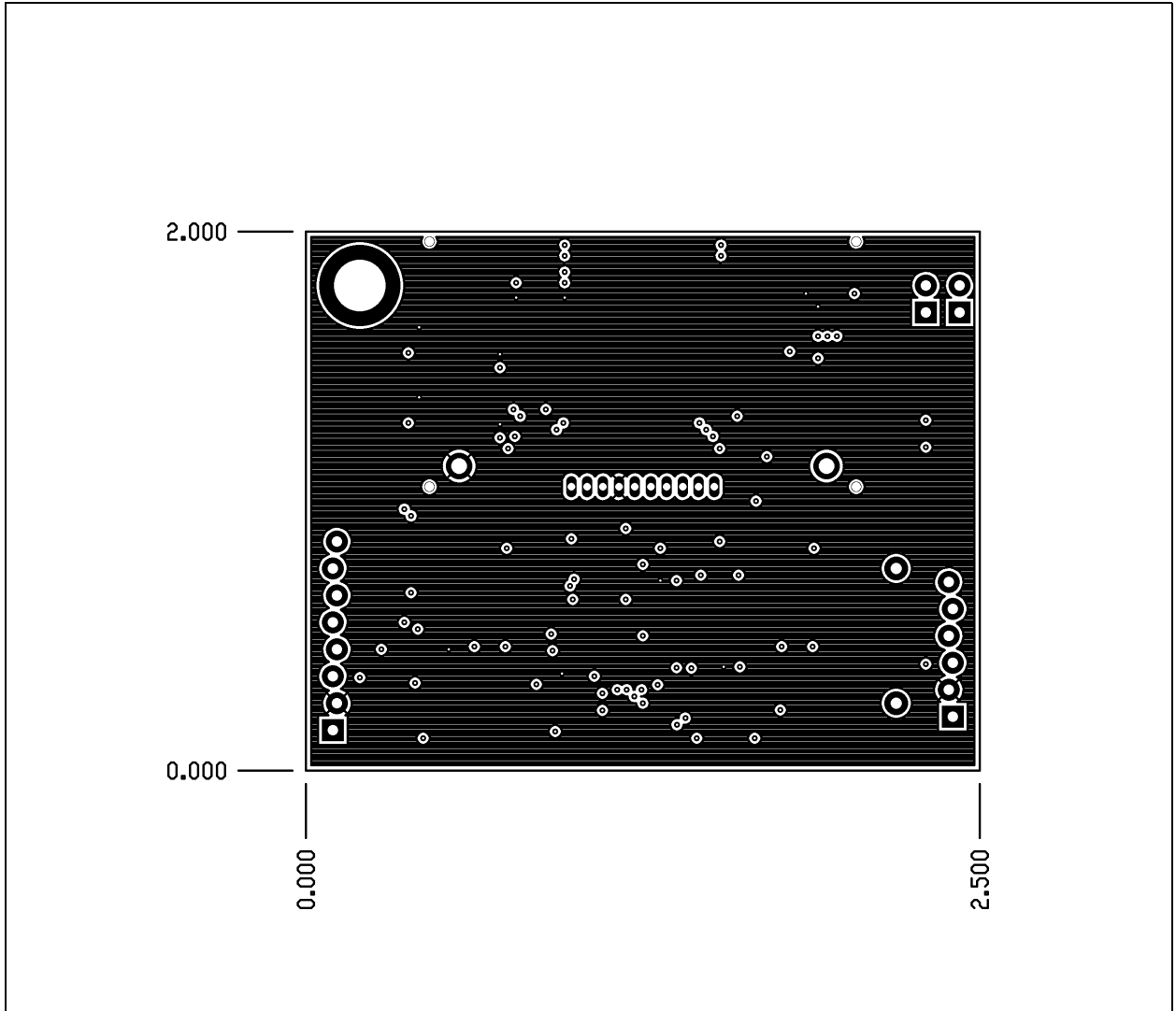
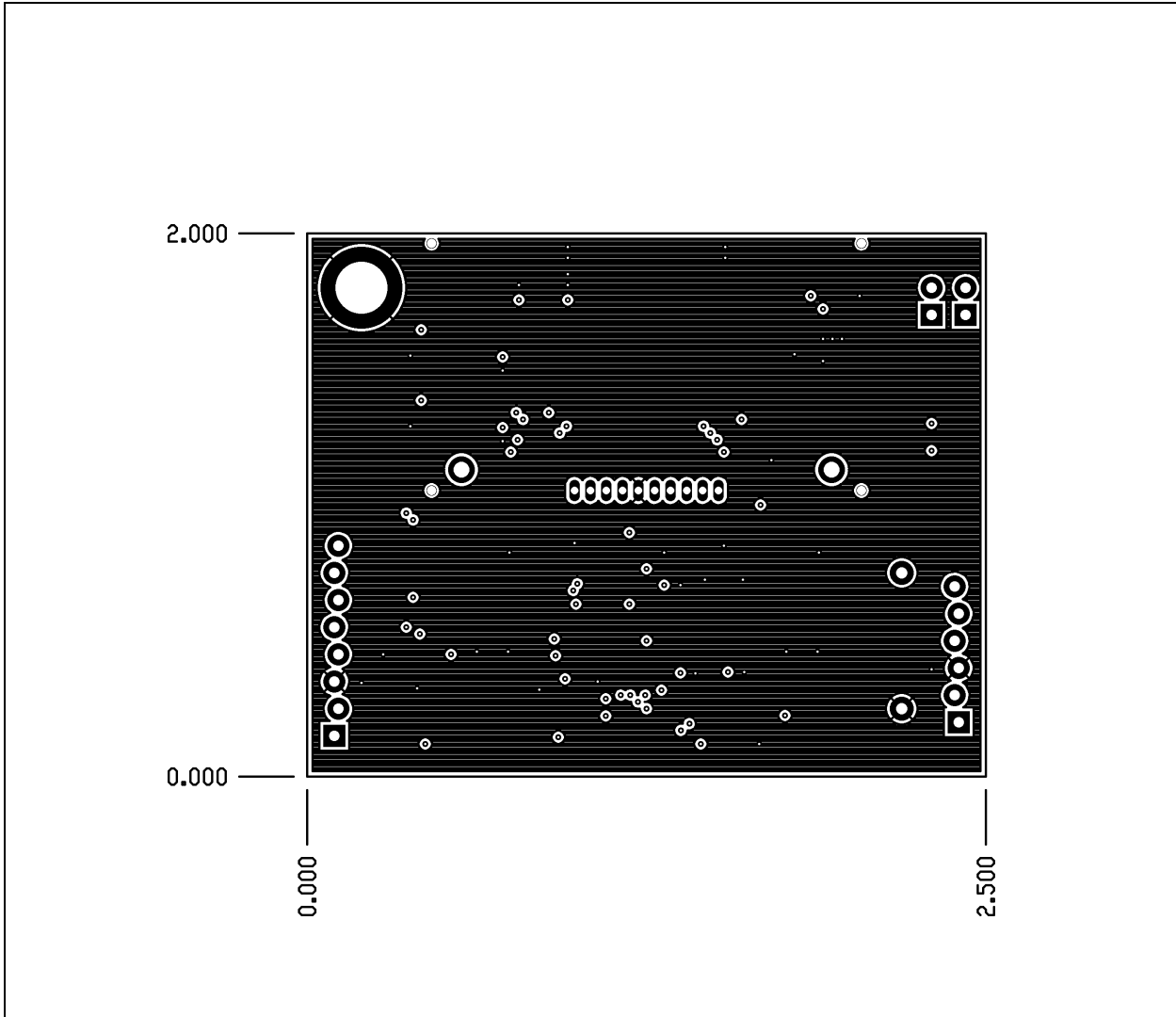

FIGURE A-9: PCB INNER LAYER 3 GROUND



## A.4 MiWi™ DEMO BOARD BILL OF MATERIALS (BOM)

FIGURE A-10: MiWi™ DEMO BOARD BILL OF MATERIALS (BOM)

Qty.	Designator	Value	Description	Manufacturer	Manufacturer Part Number
1	BT1	—	HOLDER BATTERY 2CELL AAA PC MNT	Keystone Electronics	2468
2	C90, C91	8 pF	Capacitor, Ceramic, 50V, +/-0.5pF, C0G, SMT 0603	Murata Electronics North America	GRM1885C1H8R0DZ01D
9	C1, C2, C3, C4, C6, C9, C10, C12, C13	0.1 uF	Capacitor, Ceramic, 16V, +/-10%, X7R, SMT 0603	Murata Electronics North America	GRM188R71C104KA01D
3	C7, C8, C11	1 uF	Capacitor, Ceramic, 6.3V, +/-10%, X5R, SMT 0603	Murata Electronics North America	GRM188R60J105KA01D
1	C14	4.7 uF	Capacitor, Ceramic, 6.3V, +/-20%, X5R, SMT 0805	Murata Electronics North America	GRM219R60J475ME01D
3	C5, C15	10 uF	Capacitor, Ceramic, 6.3V, +/-20%, X5R, SMT 0805	Murata Electronics North America	GRM21BR60J106ME19L
1	DS1	Green	Diode, Light Emitting	OSRAM	LG Q971-KN-1-0-20-R18
1	DS2	Yellow	Diode, Light Emitting	OSRAM	LY Q976-P1S2-36
1	DS3	Red	Diode, Light Emitting	OSRAM	LS Q976-NR-1-0-20-R18
1	L1	4.7 uH	Inductor	Coilcraft	ME3220-472ML_
1	LCD1	—	LCD, 2x16 character	Newhaven Display Intl	NHD-C0216CZ-FSW-FBW-3V3
1	Q1	—	MOSFET N-CH 20V 1.2A SOT-23	IRLML2402	International Rectifier
1	R8	100 ohms	Resistor, Thin Film, 5%, SMT 0603	Yageo	RC0603JR-07100RL
2	R1, R2	470 ohms	Resistor, Thin Film, 5%, SMT 0603	Yageo	RC0603JR-07470RL
3	R4, R5, R6	1K ohms	Resistor, Thin Film, 5%, SMT 0603	Yageo	RC0603JR-071KL
2	R3, R7	10K ohms	Resistor, Thin Film, 5%, SMT 0603	Yageo	RC0603JR-0710KL
1	R10	562K ohms	Resistor, Thin Film, 1%, SMT 0603	Yageo	RC0603FR-07562KL
1	R9	976K ohms	Resistor, Thin Film, 1%, SMT 0603	Yageo	RC0603FR-07976KL
2	SW1, SW2	—	Switch, Pushbutton, Momentary, 6x3mm SMT	C&K Components	PTS635SL25SMTR LFS
1	SW3	—	Switch, Slide DPDT, 6VDC, 0.3A, SMT	C&K Components	JS202011SCQN
1	U4	—	25AA02E48-I/SN	Microchip Technology	25AA02E48-I/SN
1	U6	—	MCP1640CT-I/CH	Microchip Technology	MCP1640CT-I/CH
1	U5	—	MCP9700A	Microchip Technology	MCP9700AT-E/LT
1	U1	—	PIC18F46J50-I/PT	Microchip Technology	PIC18F46J50-I/PT
1	U3	—	SST25VF010A	Microchip Technology	SST25VF010A-33-4C-SAE
1	X1	—	Crystal, 32.768 kHz, 9 pF, +/- 20 ppm, SMT	Micro Crystal	MS3V-T1R 32.768kHz +/-20 ppm 9 pF
1	Stand Off	—	Stacking Spacer, 0.500 inch height	Keystone Electronics	8833
<b>868 MHz Version (DM182016-2)</b>					
1	U2	—	MRF89XAM8A-I/RM	Microchip Technology	MRF89XAM8A-I/RM
<b>915 MHz Version (DM182016-3)</b>					
1	U2	—	MRF89XAM9A-I/RM	Microchip Technology	MRF89XAM9A-I/RM
<b>2.4 GHz Version (DM182016-1)</b>					
1	U2	—	MRF24J40MA-I/RM	Microchip Technology	MRF24J40MA-I/RM
<b>Separate Bag</b>					
1	J1	—	Socket, Right Angle, 6 pin, 0.100 inch spacing	Samtec	SSW-106-02-G-S-RA
1	P1	—	Header, Right Angle, 6 pin, 0.100 inch spacing	Samtec	TSW-106-08-T-S-RA
<b>Do Not Populate</b>					
1	JP1, JP2	—	Connector, Header, 2-pin, 0.100" spacing	SPC Technology	SPC20481

# MiWi™ Demo Kit User's Guide

---

NOTES:

---

---

## Index

---

---

### **B**

Block Diagrams	
High-level .....	23

### **C**

Customer Change Notification Service .....	7
Customer Support .....	7

### **D**

Documentation	
Conventions .....	5

### **I**

Internet Address .....	6
------------------------	---

### **M**

Microchip Internet Web Site .....	6
-----------------------------------	---

### **R**

Readme .....	6
--------------	---

### **S**

Schematics	
Solomon Systech SSD1926 LCD Controller	29

### **W**

WWW Address .....	6
-------------------	---



# MICROCHIP

## Worldwide Sales and Service

### AMERICAS

**Corporate Office**  
2355 West Chandler Blvd.  
Chandler, AZ 85224-6199  
Tel: 480-792-7200  
Fax: 480-792-7277  
Technical Support:  
<http://www.microchip.com/support>  
Web Address:  
[www.microchip.com](http://www.microchip.com)

**Atlanta**  
Duluth, GA  
Tel: 678-957-9614  
Fax: 678-957-1455

**Boston**  
Westborough, MA  
Tel: 774-760-0087  
Fax: 774-760-0088

**Chicago**  
Itasca, IL  
Tel: 630-285-0071  
Fax: 630-285-0075

**Cleveland**  
Independence, OH  
Tel: 216-447-0464  
Fax: 216-447-0643

**Dallas**  
Addison, TX  
Tel: 972-818-7423  
Fax: 972-818-2924

**Detroit**  
Farmington Hills, MI  
Tel: 248-538-2250  
Fax: 248-538-2260

**Indianapolis**  
Noblesville, IN  
Tel: 317-773-8323  
Fax: 317-773-5453

**Los Angeles**  
Mission Viejo, CA  
Tel: 949-462-9523  
Fax: 949-462-9608

**Santa Clara**  
Santa Clara, CA  
Tel: 408-961-6444  
Fax: 408-961-6445

**Toronto**  
Mississauga, Ontario,  
Canada  
Tel: 905-673-0699  
Fax: 905-673-6509

### ASIA/PACIFIC

**Asia Pacific Office**  
Suites 3707-14, 37th Floor  
Tower 6, The Gateway  
Harbour City, Kowloon  
Hong Kong  
Tel: 852-2401-1200  
Fax: 852-2401-3431

**Australia - Sydney**  
Tel: 61-2-9868-6733  
Fax: 61-2-9868-6755

**China - Beijing**  
Tel: 86-10-8569-7000  
Fax: 86-10-8528-2104

**China - Chengdu**  
Tel: 86-28-8665-5511  
Fax: 86-28-8665-7889

**China - Chongqing**  
Tel: 86-23-8980-9588  
Fax: 86-23-8980-9500

**China - Hangzhou**  
Tel: 86-571-2819-3187  
Fax: 86-571-2819-3189

**China - Hong Kong SAR**  
Tel: 852-2401-1200  
Fax: 852-2401-3431

**China - Nanjing**  
Tel: 86-25-8473-2460  
Fax: 86-25-8473-2470

**China - Qingdao**  
Tel: 86-532-8502-7355  
Fax: 86-532-8502-7205

**China - Shanghai**  
Tel: 86-21-5407-5533  
Fax: 86-21-5407-5066

**China - Shenyang**  
Tel: 86-24-2334-2829  
Fax: 86-24-2334-2393

**China - Shenzhen**  
Tel: 86-755-8203-2660  
Fax: 86-755-8203-1760

**China - Wuhan**  
Tel: 86-27-5980-5300  
Fax: 86-27-5980-5118

**China - Xian**  
Tel: 86-29-8833-7252  
Fax: 86-29-8833-7256

**China - Xiamen**  
Tel: 86-592-2388138  
Fax: 86-592-2388130

**China - Zhuhai**  
Tel: 86-756-3210040  
Fax: 86-756-3210049

### ASIA/PACIFIC

**India - Bangalore**  
Tel: 91-80-3090-4444  
Fax: 91-80-3090-4123

**India - New Delhi**  
Tel: 91-11-4160-8631  
Fax: 91-11-4160-8632

**India - Pune**  
Tel: 91-20-2566-1512  
Fax: 91-20-2566-1513

**Japan - Osaka**  
Tel: 81-66-152-7160  
Fax: 81-66-152-9310

**Japan - Yokohama**  
Tel: 81-45-471-6166  
Fax: 81-45-471-6122

**Korea - Daegu**  
Tel: 82-53-744-4301  
Fax: 82-53-744-4302

**Korea - Seoul**  
Tel: 82-2-554-7200  
Fax: 82-2-558-5932 or  
82-2-558-5934

**Malaysia - Kuala Lumpur**  
Tel: 60-3-6201-9857  
Fax: 60-3-6201-9859

**Malaysia - Penang**  
Tel: 60-4-227-8870  
Fax: 60-4-227-4068

**Philippines - Manila**  
Tel: 63-2-634-9065  
Fax: 63-2-634-9069

**Singapore**  
Tel: 65-6334-8870  
Fax: 65-6334-8850

**Taiwan - Hsin Chu**  
Tel: 886-3-5778-366  
Fax: 886-3-5770-955

**Taiwan - Kaohsiung**  
Tel: 886-7-536-4818  
Fax: 886-7-330-9305

**Taiwan - Taipei**  
Tel: 886-2-2500-6610  
Fax: 886-2-2508-0102

**Thailand - Bangkok**  
Tel: 66-2-694-1351  
Fax: 66-2-694-1350

### EUROPE

**Austria - Wels**  
Tel: 43-7242-2244-39  
Fax: 43-7242-2244-393

**Denmark - Copenhagen**  
Tel: 45-4450-2828  
Fax: 45-4485-2829

**France - Paris**  
Tel: 33-1-69-53-63-20  
Fax: 33-1-69-30-90-79

**Germany - Munich**  
Tel: 49-89-627-144-0  
Fax: 49-89-627-144-44

**Italy - Milan**  
Tel: 39-0331-742611  
Fax: 39-0331-466781

**Netherlands - Druenen**  
Tel: 31-416-690399  
Fax: 31-416-690340

**Spain - Madrid**  
Tel: 34-91-708-08-90  
Fax: 34-91-708-08-91

**UK - Wokingham**  
Tel: 44-118-921-5869  
Fax: 44-118-921-5820

11/29/11