

FEATURES

- 5A Onboard Switch (LT1074)
- Operates Up to 60V Input
- 100kHz Switching Frequency
- Greatly Improved Dynamic Behavior
- Available in Low Cost 5 and 7-Lead Packages
- Only 8.5mA Quiescent Current
- Programmable Current Limit
- Micropower Shutdown Mode

APPLICATIONS

- Buck Converter with Output Voltage Range of 2.5V to 50V
- Tapped-Inductor Buck Converter with 10A Output at 5V
- Positive-to-Negative Converter
- Negative Boost Converter
- Multiple Output Buck Converter

DESCRIPTION

The LT[®]1074 is a 5A (LT1076 is rated at 2A) monolithic bipolar switching regulator which requires only a few external parts for normal operation. The power switch, all oscillator and control circuitry, and all current limit com-

ponents, are included on the chip. The topology is a classic positive “buck” configuration but several design innovations allow this device to be used as a positive-to-negative converter, a negative boost converter, and as a flyback converter. The switch output is specified to swing 40V below ground, allowing the LT1074 to drive a tapped-inductor in the buck mode with output currents up to 10A.

The LT1074 uses a true analog multiplier in the feedback loop. This makes the device respond nearly instantaneously to input voltage fluctuations and makes loop gain independent of input voltage. As a result, dynamic behavior of the regulator is significantly improved over previous designs.

On-chip pulse by pulse current limiting makes the LT1074 nearly bust-proof for output overloads or shorts. The input voltage range as a buck converter is 8V to 60V, but a self-boot feature allows input voltages as low as 5V in the inverting and boost configurations.

The LT1074 is available in low cost TO-220 or DD packages with frequency pre-set at 100kHz and current limit at 6.5A (LT1076 = 2.6A). A 7-pin TO-220 package is also available which allows current limit to be adjusted down to zero. In addition, full micropower shutdown can be programmed. See Application Note 44 for design details.

A fixed 5V output, 2A version is also available. See LT1076-5.

LT, LTC and LT are registered trademarks of Linear Technology Corporation.

TYPICAL APPLICATION



Buck Converter Efficiency

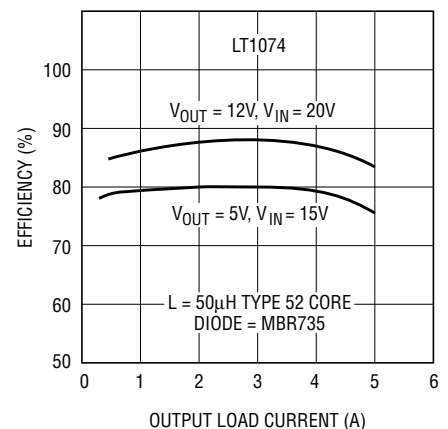

LT1074/LT1076

ABSOLUTE MAXIMUM RATINGS (Note 1)

Input Voltage	I_{LIM} Pin Voltage (Forced)	5.5V
LT1074/ LT1076	Maximum Operating Ambient Temperature Range	
LT1074HV/LT1076HV	Commercial	0°C to 70°C
Switch Voltage with Respect to Input Voltage	Industrial	-40°C to 85°C
LT1074/ LT1076	Military (OBSOLETE)	-55°C to 125°C
LT1074HV/LT1076HV	Maximum Operating Junction Temperature Range	
Switch Voltage with Respect to Ground Pin (V_{SW} Negative)	Commercial	0°C to 125°C
LT1074/LT1076 (Note 7)	Industrial	-40°C to 125°C
LT1074HV/LT1076HV (Note 7)	Military (OBSOLETE)	-55°C to 150°C
Feedback Pin Voltage	Maximum Storage Temperature	-65°C to 150°C
Shutdown Pin Voltage (Not to Exceed V_{IN})	Lead Temperature (Soldering, 10 sec)	300°C

PACKAGE/ORDER INFORMATION

<p>FRONT VIEW</p> <p>TAB IS GND</p> <p>Q PACKAGE 5-LEAD PLASTIC DD</p> <p>LT1076: $\theta_{JC} = 4^{\circ}\text{C}$, $\theta_{JA} = 30^{\circ}\text{C/W}$</p>	<p>ORDER PART NUMBER</p> <p>LT1076CQ LT1076IQ</p>	<p>BOTTOM VIEW</p> <p>V_C V_{IN} V_{SW} FB CASE IS GND</p> <p>K PACKAGE 4-LEAD TO-3 METAL CAN</p> <p>LT1074: $\theta_{JC} = 2.5^{\circ}\text{C}$, $\theta_{JA} = 35^{\circ}\text{C/W}$ LT1076: $\theta_{JC} = 4^{\circ}\text{C}$, $\theta_{JA} = 35^{\circ}\text{C/W}$</p> <p>OBSOLETE PACKAGE Consider the T5 Package for Alternate Source</p>	<p>ORDER PART NUMBER</p> <p>LT1074CK LT1074HVCK LT1074MK LT1074HVMK LT1076CK LT1076HVCK LT1076MK LT1076HVMK</p>
<p>FRONT VIEW</p> <p>TAB IS GND</p> <p>R PACKAGE 7-LEAD PLASTIC DD</p> <p>LT1076: $\theta_{JC} = 4^{\circ}\text{C}$, $\theta_{JA} = 30^{\circ}\text{C/W}$</p>	<p>LT1076CR LT1076IR LT1076HVCR LT1076HVIR</p>	<p>FRONT VIEW</p> <p>TAB IS GND</p> <p>T PACKAGE 5-LEAD PLASTIC TO-220 LEADS ARE FORMED STANDARD FOR STRAIGHT LEADS, ORDER FLOW 06</p> <p>LT1074: $\theta_{JC} = 2.5^{\circ}\text{C}$, $\theta_{JA} = 50^{\circ}\text{C/W}$ LT1076: $\theta_{JC} = 4^{\circ}\text{C}$, $\theta_{JA} = 50^{\circ}\text{C/W}$</p>	<p>LT1074CT LT1074HVCT LT1074IT LT1074HVIT LT1076CT LT1076HVCT LT1076IT LT1076HVIT</p>
<p>FRONT VIEW</p> <p>TAB IS GND</p> <p>T7 PACKAGE 7-LEAD PLASTIC TO-220</p> <p>LT1074: $\theta_{JC} = 2.5^{\circ}\text{C}$, $\theta_{JA} = 50^{\circ}\text{C/W}$ LT1076: $\theta_{JC} = 4^{\circ}\text{C}$, $\theta_{JA} = 50^{\circ}\text{C/W}$</p>	<p>LT1074CT7 LT1074HVCT7 LT1074IT7 LT1074HVIT7 LT1076CT7 LT1076HVCT7</p>		

*Assumes package is soldered to 0.5 IN² of 1 oz. copper over internal ground plane or over back side plane. Consult LTC Marketing for parts specified with wider operating temperature ranges.

ELECTRICAL CHARACTERISTICS The ● denotes the specifications which apply over the full operating temperature range, otherwise specifications are at $T_A = 25^\circ\text{C}$. $T_j = 25^\circ\text{C}$, $V_{IN} = 25\text{V}$, unless otherwise noted.

PARAMETER	CONDITIONS	MIN	TYP	MAX	UNITS	
Switch "On" Voltage (Note 2)	LT1074 $I_{SW} = 1\text{A}$, $T_j \geq 0^\circ\text{C}$			1.85	V	
	$I_{SW} = 1\text{A}$, $T_j < 0^\circ\text{C}$			2.1	V	
	$I_{SW} = 5\text{A}$, $T_j \geq 0^\circ\text{C}$			2.3	V	
	$I_{SW} = 5\text{A}$, $T_j < 0^\circ\text{C}$			2.5	V	
	LT1076 $I_{SW} = 0.5\text{A}$	●		1.2	V	
	$I_{SW} = 2\text{A}$	●		1.7	V	
Switch "Off" Leakage	LT1074 $V_{IN} \leq 25\text{V}$, $V_{SW} = 0$		5	300	μA	
	$V_{IN} = V_{MAX}$, $V_{SW} = 0$ (Note 8)		10	500	μA	
	LT1076 $V_{IN} = 25\text{V}$, $V_{SW} = 0$			150	μA	
	$V_{IN} = V_{MAX}$, $V_{SW} = 0$ (Note 8)			250	μA	
Supply Current (Note 3)	$V_{FB} = 2.5\text{V}$, $V_{IN} \leq 40\text{V}$	●	8.5	11	mA	
	$40\text{V} < V_{IN} < 60\text{V}$	●	9	12	mA	
	$V_{SHUT} = 0.1\text{V}$ (Device Shutdown) (Note 9)	●	140	300	μA	
Minimum Supply Voltage	Normal Mode	●	7.3	8	V	
	Startup Mode (Note 4)	●	3.5	4.8	V	
Switch Current Limit (Note 5)	LT1074 I_{LIM} Open	●	5.5	6.5	A	
	$R_{LIM} = 10\text{k}$ (Note 6)			4.5	A	
	$R_{LIM} = 7\text{k}$ (Note 6)			3	A	
	LT1076 I_{LIM} Open	●	2	2.6	A	
	$R_{LIM} = 10\text{k}$ (Note 6)			1.8	A	
	$R_{LIM} = 7\text{k}$ (Note 6)			1.2	A	
Maximum Duty Cycle		●	85	90	%	
Switching Frequency	$T_j \leq 125^\circ\text{C}$	●	90	100	110	kHz
	$T_j > 125^\circ\text{C}$	●	85		120	kHz
	$V_{FB} = 0\text{V}$ through $2\text{k}\Omega$ (Note 5)	●	85		125	kHz
				20		kHz
Switching Frequency Line Regulation	$8\text{V} \leq V_{IN} \leq V_{MAX}$ (Note 8)	●		0.03	0.1	%/V
Error Amplifier Voltage Gain (Note 7)	$1\text{V} \leq V_C \leq 4\text{V}$			2000		V/V
Error Amplifier Transconductance			3700	5000	8000	μmho
Error Amplifier Source and Sink Current	Source ($V_{FB} = 2\text{V}$)		100	140	225	μA
	Sink ($V_{FB} = 2.5\text{V}$)		0.7	1	1.6	mA
Feedback Pin Bias Current	$V_{FB} = V_{REF}$	●		0.5	2	μA
Reference Voltage	$V_C = 2\text{V}$	●	2.155	2.21	2.265	V
Reference Voltage Tolerance	V_{REF} (Nominal) = 2.21V			± 0.5	± 1.5	%
	All Conditions of Input Voltage, Output Voltage, Temperature and Load Current	●		± 1	± 2.5	%
Reference Voltage Line Regulation	$8\text{V} \leq V_{IN} \leq V_{MAX}$ (Note 8)	●		0.005	0.02	%/V
V_C Voltage at 0% Duty Cycle				1.5		V
	Over Temperature	●		-4		$\text{mV}/^\circ\text{C}$
Multiplier Reference Voltage				24		V
Shutdown Pin Current	$V_{SH} = 5\text{V}$	●	5	10	20	μA
	$V_{SH} \leq V_{THRESHOLD} (\cong 2.5\text{V})$	●			50	μA
Shutdown Thresholds	Switch Duty Cycle = 0	●	2.2	2.45	2.7	V
	Fully Shut Down	●	0.1	0.3	0.6	V
Thermal Resistance Junction to Case	LT1074			2.5		$^\circ\text{C}/\text{W}$
	LT1076			4.0		$^\circ\text{C}/\text{W}$

BLOCK DIAGRAM DESCRIPTION

A switch cycle in the LT1074 is initiated by the oscillator setting the R/S latch. The pulse that sets the latch also locks out the switch via gate G1. The effective width of this pulse is approximately 700ns, which sets the maximum switch duty cycle to approximately 93% at 100kHz switching frequency. The switch is turned off by comparator C1, which resets the latch. C1 has a sawtooth waveform as one input and the output of an analog multiplier as the other input. The multiplier output is the product of an internal reference voltage, and the output of the error amplifier, A1, divided by the regulator input voltage. In standard buck regulators, this means that the output voltage of A1 required to keep a constant regulated output is independent of regulator input voltage. This greatly improves line transient response, and makes loop gain independent of input voltage. The error amplifier is a transconductance type with a G_M at null of approximately 5000 μ mho. Slew current going positive is 140 μ A, while negative slew current is about 1.1mA. This asymmetry helps prevent overshoot on start-up. Overall loop frequency compensation is accomplished with a series RC network from V_C to ground.

Switch current is continuously monitored by C2, which resets the R/S latch to turn the switch off if an overcurrent condition occurs. The time required for detection and switch turn off is approximately 600ns. So minimum switch “on” time in current limit is 600ns. Under dead shorted output conditions, switch duty cycle may have to be as low as 2% to maintain control of output current. This would require switch on time of 200ns at 100kHz switching frequency, so frequency is reduced at very low output

voltages by feeding the FB signal into the oscillator and creating a linear frequency downshift when the FB signal drops below 1.3V. Current trip level is set by the voltage on the I_{LIM} pin which is driven by an internal 320 μ A current source. When this pin is left open, it self-clamps at about 4.5V and sets current limit at 6.5A for the LT1074 and 2.6A for the LT1076. In the 7-pin package an external resistor can be connected from the I_{LIM} pin to ground to set a lower current limit. A capacitor in parallel with this resistor will soft-start the current limit. A slight offset in C2 guarantees that when the I_{LIM} pin is pulled to within 200mV of ground, C2 output will stay high and force switch duty cycle to zero.

The “Shutdown” pin is used to force switch duty cycle to zero by pulling the I_{LIM} pin low, or to completely shut down the regulator. Threshold for the former is approximately 2.35V, and for complete shutdown, approximately 0.3V. Total supply current in shutdown is about 150 μ A. A 10 μ A pull-up current forces the shutdown pin high when left open. A capacitor can be used to generate delayed start-up. A resistor divider will program “undervoltage lockout” if the divider voltage is set at 2.35V when the input is at the desired trip point.

The switch used in the LT1074 is a Darlington NPN (single NPN for LT1076) driven by a saturated PNP. Special patented circuitry is used to drive the PNP on and off very quickly even from the saturation state. This particular switch arrangement has no “isolation tubs” connected to the switch output, which can therefore swing to 40V below ground.

TYPICAL PERFORMANCE CHARACTERISTICS

V_C Pin Characteristics

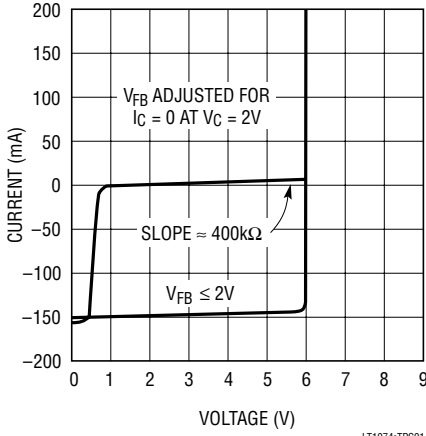

LT1074-TPC01

V_C Pin Characteristics

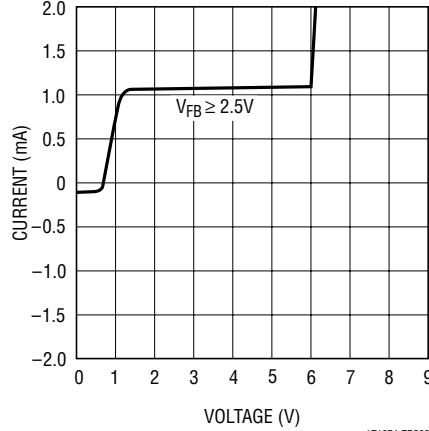

LT1074-TPC02

Feedback Pin Characteristics

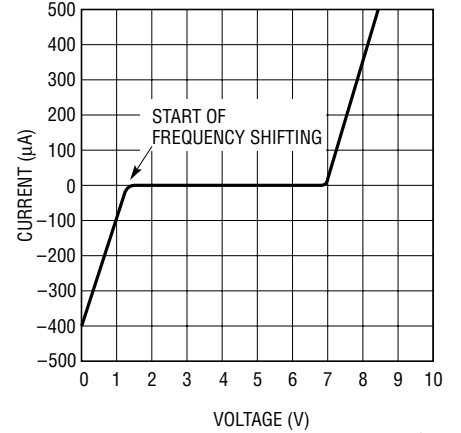

LT1074-TPC03

Shutdown Pin Characteristics

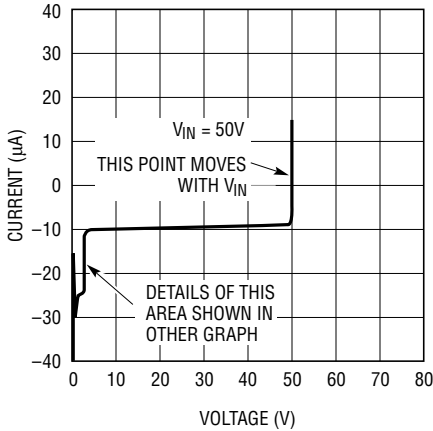

LT1074-TPC04

Shutdown Pin Characteristics

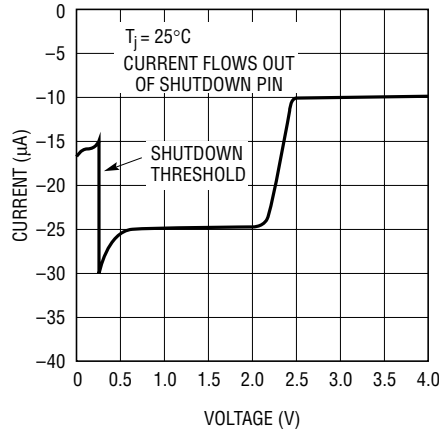

LT1074-TPC05

I_{LIM} Pin Characteristics

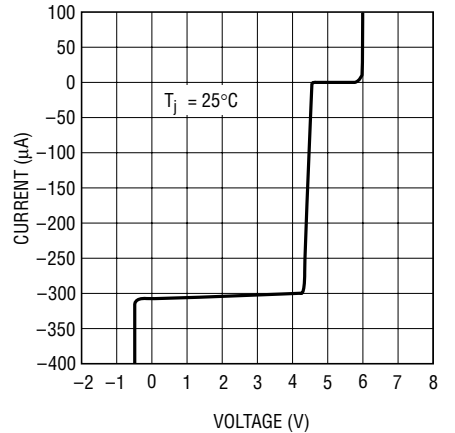

LT1074-TPC06

Supply Current

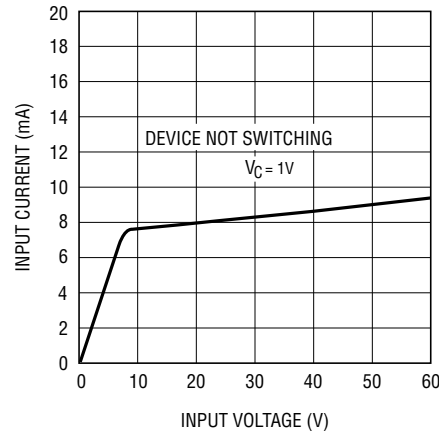

LT1074-TPC11

TYPICAL PERFORMANCE CHARACTERISTICS

Supply Current (Shutdown)

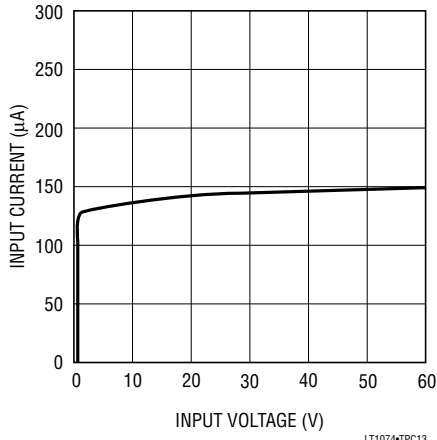

Reference Voltage vs Temperature

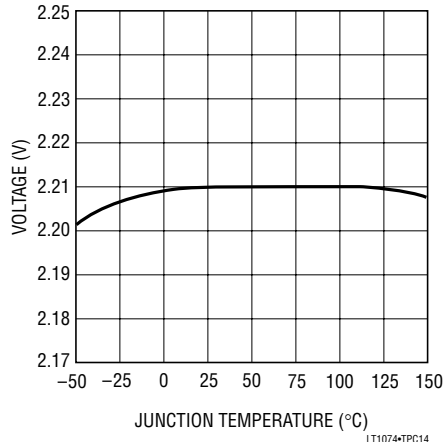

Switch "On" Voltage

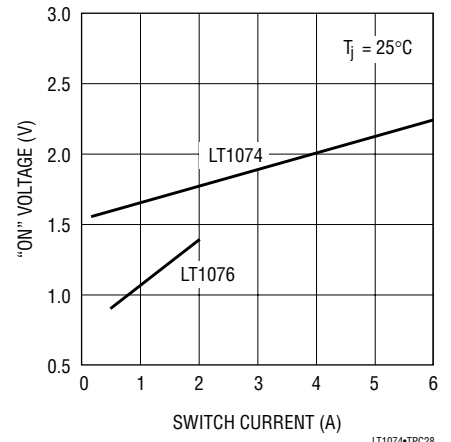

Reference Shift with Ripple Voltage

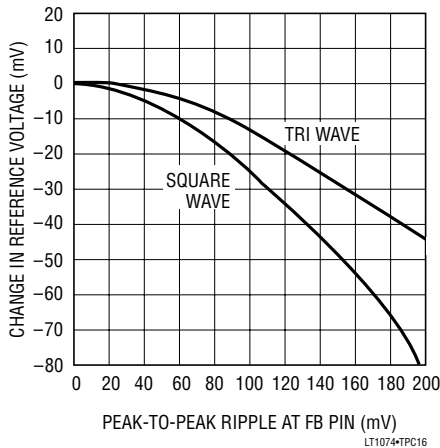

Error Amplifier Phase and G_M

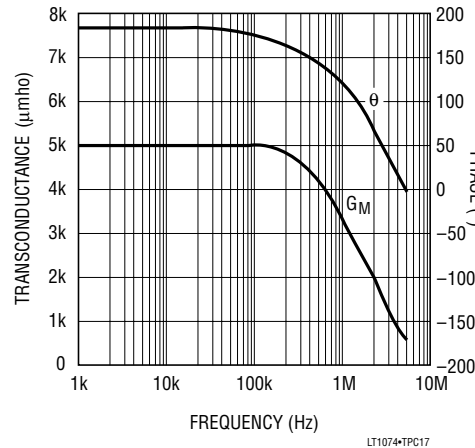

Switching Frequency vs Temperature

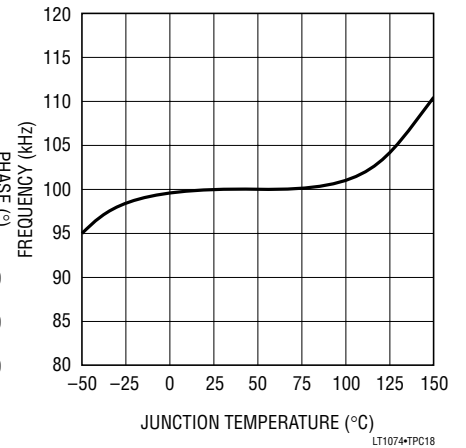

Feedback Pin Frequency Shift

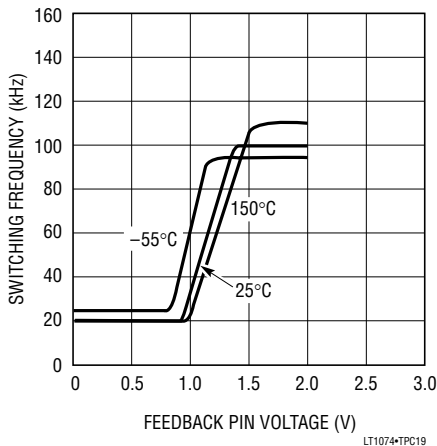

Current Limit vs Temperature*

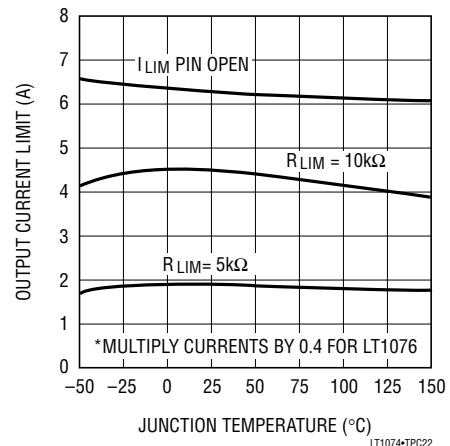

PIN DESCRIPTIONS

V_{IN} PIN

The V_{IN} pin is both the supply voltage for internal control circuitry and one end of the high current switch. It is important, *especially at low input voltages*, that this pin be bypassed with a low ESR, and low inductance capacitor to prevent transient steps or spikes from causing erratic operation. At full switch current of 5A, the switching transients at the regulator input can get very large as shown in Figure 1. Place the input capacitor very close to the regulator and connect it with wide traces to avoid extra inductance. Use radial lead capacitors.

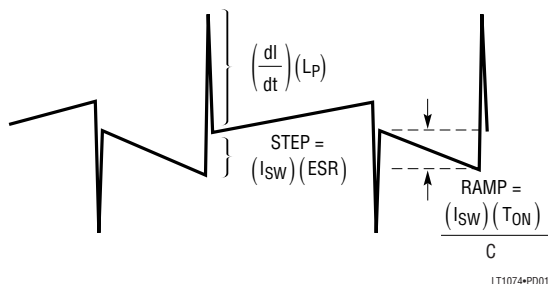

Figure 1. Input Capacitor Ripple

L_p = Total inductance in input bypass connections and capacitor.

“Spike” height (dl/dt • L_p) is approximately 2V per inch of lead length for LT1074 and 0.8V per inch for LT1076.

“Step” for ESR = 0.05Ω and I_{SW} = 5A is 0.25V.
 “Ramp” for C = 200μF, T_{ON} = 5μs, and I_{SW} = 5A, is 0.12V.

Input current on the V_{IN} Pin in shutdown mode is the sum of actual supply current (≈140μA, with a maximum of 300μA), and switch leakage current. Consult factory for special testing if shutdown mode input current is critical.

GROUND PIN

It might seem unusual to describe a ground pin, but in the case of regulators, the ground pin must be connected properly to ensure good load regulation. The internal reference voltage is referenced to the ground pin; so any error in ground pin voltage will be multiplied at the output;

$$\Delta V_{OUT} = \frac{(\Delta V_{GND})(V_{OUT})}{2.21}$$

To ensure good load regulation, the ground pin must be connected directly to the proper output node, so that no high currents flow in this path. The output divider resistor should also be connected to this low current connection line as shown in Figure 2.

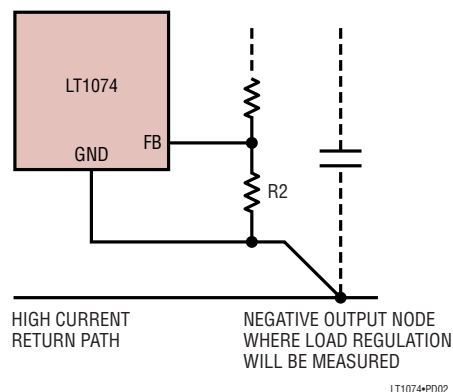

Figure 2. Proper Ground Pin Connection

FEEDBACK PIN

The feedback pin is the inverting input of an error amplifier which controls the regulator output by adjusting duty cycle. The noninverting input is internally connected to a trimmed 2.21V reference. Input bias current is typically 0.5μA when the error amplifier is balanced (I_{OUT} = 0). The error amplifier has asymmetrical G_M for large input signals to reduce startup overshoot. This makes the amplifier more sensitive to large ripple voltages at the feedback pin. 100mVp-p ripple at the feedback pin will create a 14mV offset in the amplifier, equivalent to a 0.7% output voltage shift. To avoid output errors, output ripple (P-P) should be less than 4% of DC output voltage at the point where the output divider is connected.

See the “Error Amplifier” section for more details.

Frequency Shifting at the Feedback Pin

The error amplifier feedback pin (FB) is used to downshift the oscillator frequency when the regulator output voltage is low. This is done to guarantee that output short-circuit

PIN DESCRIPTIONS

current is well controlled even when switch duty cycle must be extremely low. Theoretical switch “on” time for a buck converter in continuous mode is:

$$t_{ON} = \frac{V_{OUT} + V_D}{V_{IN} \cdot f}$$

V_D = Catch diode forward voltage ($\approx 0.5V$)
 f = Switching frequency

At $f = 100kHz$, t_{ON} must drop to $0.2\mu s$ when $V_{IN} = 25V$ and the output is shorted ($V_{OUT} = 0V$). In current limit, the LT1074 can reduce t_{ON} to a minimum value of $\approx 0.6\mu s$, much too long to control current correctly for $V_{OUT} = 0$. To correct this problem, switching frequency is lowered from $100kHz$ to $20kHz$ as the FB pin drops from $1.3V$ to $0.5V$. This is accomplished by the circuitry



Figure 3. Frequency Shifting

shown in Figure 3.

Q1 is off when the output is regulating ($V_{FB} = 2.21V$). As the output is pulled down by an overload, V_{FB} will eventually reach $1.3V$, turning on Q1. As the output continues to drop, Q1 current increases proportionately and lowers the frequency of the oscillator. Frequency shifting starts when the output is $\approx 60\%$ of normal value, and is down to its minimum value of $\approx 20kHz$ when the output is $\approx 20\%$ of normal value. The rate at which frequency is shifted is determined by both the internal $3k$ resistor R3 and the external divider resistors. For this reason, R2 should not be increased to more than $4k\Omega$, if the LT1074 will be subjected to the simultaneous conditions of high input voltage and output short-circuit.

SHUTDOWN PIN

The shutdown pin is used for undervoltage lockout, micro-power shutdown, soft-start, delayed start, or as a general purpose on/off control of the regulator output. It controls switching action by pulling the I_{LIM} pin low, which forces the switch to a continuous “off” state. Full micropower shutdown is initiated when the shutdown pin drops below $0.3V$.

The V/I characteristics of the shutdown pin are shown in Figure 4. For voltages between $2.5V$ and $\approx V_{IN}$, a current of $10\mu A$ flows out of the shutdown pin. This current increases to $\approx 25\mu A$ as the shutdown pin moves through the $2.35V$ threshold. The current increases further to $\approx 30\mu A$ at the $0.3V$ threshold, then drops to $\approx 15\mu A$ as the shutdown voltage fall below $0.3V$. The $10\mu A$ current source is included to pull the shutdown pin to its high or default state when left open. It also provides a convenient pull-up for delayed start applications with a capacitor on the shutdown pin.

When activated, the typical collector current of Q1 in Figure 5, is $\approx 2mA$. A soft-start capacitor on the I_{LIM} pin will delay regulator shutdown in response to C1, by $\approx (5V)(C_{LIM})/2mA$. Soft-start after full micropower shutdown is ensured by coupling C2 to Q1.



Figure 4. Shutdown Pin Characteristics

PIN DESCRIPTIONS



Figure 5. Shutdown Circuitry

Undervoltage Lockout

Undervoltage lockout point is set by R1 and R2 in Figure 6. To avoid errors due to the 10µA shutdown pin current, R2 is usually set at 5k, and R1 is found from:

$$R1 = R2 \frac{(V_{TP} - V_{SH})}{V_{SH}}$$

V_{TP} = Desired undervoltage lockout voltage

V_{SH} = Threshold for lockout on the shutdown pin = 2.45V

If quiescent supply current is critical, R2 may be increased up to 15kΩ, but the denominator in the formula for R2 should replace V_{SH} with $V_{SH} - (10\mu A)(R2)$.



Figure 6. Undervoltage Lockout

Hysteresis in undervoltage lockout may be accomplished by connecting a resistor (R3) from the I_{LIM} pin to the shutdown pin as shown in Figure 7. D1 prevents the shutdown divider from altering current limit.



Figure 7. Adding Hysteresis

$$\text{Trip Point} = V_{TP} = 2.35V \left(1 + \frac{R1}{R2} \right)$$

If R3 is added, the lower trip point (V_{IN} descending) will be the same. The upper trip point (V_{UTP}) will be:

$$V_{UTP} = V_{SH} \left(1 + \frac{R1}{R2} + \frac{R1}{R3} \right) - 0.8V \left(\frac{R1}{R3} \right)$$

If R1 and R2 are chosen, R3 is given by:

$$R3 = \frac{(V_{SH} - 0.8V)(R1)}{V_{UTP} - V_{SH} \left(1 + \frac{R1}{R2} \right)}$$

Example: An undervoltage lockout is required such that the output will not start until $V_{IN} = 20V$, but will continue to operate until V_{IN} drops to 15V. Let $R2 = 2.32k$.

$$R1 = (2.34k) \frac{(15V - 2.35V)}{2.35V} = 12.5k$$

$$R3 = \frac{(2.35 - 0.8)(12.5)}{20 - 2.35 \left(1 + \frac{12.5}{2.32} \right)} = 3.9k$$

PIN DESCRIPTIONS

I_{LIM} PIN

The I_{LIM} pin is used to reduce current limit below the preset value of 6.5A. The equivalent circuit for this pin is shown in Figure 8.



Figure 8. I_{LIM} Pin Circuit

When I_{LIM} is left open, the voltage at Q1 base clamps at 5V through D2. Internal current limit is determined by the current through Q1. If an external resistor is connected between I_{LIM} and ground, the voltage at Q1 base can be reduced for lower current limit. The resistor will have a voltage across it equal to (320µA)(R), limited to ≈5V when clamped by D2. Resistance required for a given current limit is:

$$R_{LIM} = I_{LIM}(2k\Omega) + 1k\Omega \text{ (LT1074)}$$

$$R_{LIM} = I_{LIM}(5.5k\Omega) + 1k\Omega \text{ (LT1076)}$$

As an example, a 3A current limit would require 3A(2k) + 1k = 7kΩ for the LT1074. The accuracy of these formulas is ±25% for 2A ≤ I_{LIM} ≤ 5A (LT1074) and 7A ≤ I_{LIM} ≤ 1.8A (LT1076), so I_{LIM} should be set at least 25% above the *peak* switch current required.

Foldback current limiting can be easily implemented by adding a resistor from the output to the I_{LIM} pin as shown in Figure 9. This allows full desired current limit (with or without R_{LIM}) when the output is regulating, but reduces current limit under short-circuit conditions. A typical value for R_{FB} is 5kΩ, but this may be adjusted up or down to set the amount of foldback. D2 prevents the output voltage

from forcing current back into the I_{LIM} pin. To calculate a value for R_{FB}, first calculate R_{LIM}, the R_{FB}:

$$R_{FB} = \frac{(I_{SC} - 0.44^*)(R_L)}{0.5^*(R_L - 1k\Omega) - I_{SC}} \text{ (R}_L \text{ in } k\Omega)$$

*Change 0.44 to 0.16, and 0.5 to 0.18 for LT1076.

Example: I_{LIM} = 4A, I_{SC} = 1.5A, R_{LIM} = (4)(2k) + 1k = 9k

$$R_{FB} = \frac{(1.5 - 0.44)(9k\Omega)}{0.5(9k - 1k) - 1.5} \text{ (3.8k}\Omega)$$

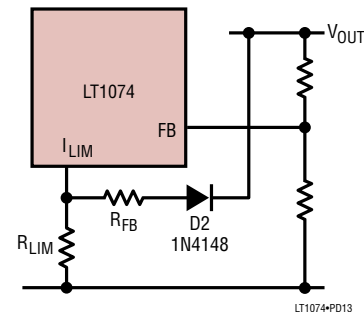

Figure 9. Foldback Current Limit

Error Amplifier

The error amplifier in Figure 10 is a single stage design with added inverters to allow the output to swing above and below the common mode input voltage. One side of the amplifier is tied to a trimmed internal reference voltage of 2.21V. The other input is brought out as the FB (feedback) pin. This amplifier has a G_M (voltage “in” to current “out”) transfer function of ≈5000µmho. Voltage gain is determined by multiplying G_M times the total equivalent output loading, consisting of the output resistance of Q4 and Q6 in parallel with the series RC external frequency compensation network. At DC, the external RC is ignored, and with a parallel output impedance for Q4 and Q6 of 400kΩ, voltage gain is ≈2000. At frequencies above a few hertz, voltage gain is determined by the external compensation, R_C and C_C.

PIN DESCRIPTIONS



Figure 10. Error Amplifier

$$A_V = \frac{G_m}{2\pi \cdot f \cdot C_C} \text{ at mid frequencies}$$

$$A_V = G_m \cdot R_C \text{ at high frequencies}$$

Phase shift from the FB pin to the V_C pin is 90° at mid frequencies where the external C_C is controlling gain, then drops back to 0° (actually 180° since FB is an inverting input) when the reactance of C_C is small compared to R_C . The low frequency “pole” where the reactance of C_C is equal to the output impedance of Q4 and Q6 (r_O), is:

$$f_{POLE} = \frac{1}{2\pi \cdot r_O \cdot C} r_O \approx 400\text{k}\Omega$$

Although f_{POLE} varies as much as 3:1 due to r_O variations, mid-frequency gain is dependent only on G_m , which is specified much tighter on the data sheet. The higher frequency “zero” is determined solely by R_C and C_C .

$$f_{ZERO} = \frac{1}{2\pi \cdot R_C \cdot C_C}$$

The error amplifier has asymmetrical peak output current. Q3 and Q4 current mirrors are unity-gain, but the Q6 mirror has a gain of 1.8 at output null and a gain of 8 when the FB pin is high (Q1 current = 0). This results in a maximum positive output current of $140\mu\text{A}$ and a maximum negative (sink) output current of $\approx 1.1\text{mA}$. The asymmetry is deliberate—it results in much less regulator output overshoot during rapid start-up or following the release of an output overload. Amplifier offset is kept low by area scaling Q1 and Q2 at 1.8:1.

Amplifier swing is limited by the internal 5.8V supply for positive outputs and by D1 and D2 when the output goes low. Low clamp voltage is approximately one diode drop ($\approx 0.7\text{V} - 2\text{mV}/^\circ\text{C}$).

Note that both the FB pin and the V_C pin have other internal connections. Refer to the frequency shifting and synchronizing discussions.

TYPICAL APPLICATIONS

Tapped-Inductor Buck Converter



* PULSE ENGINEERING #PE±65282
 ** MOTOROLA MBR2030CTL
 † IF INPUT VOLTAGE IS BELOW 20V,
 MAXIMUM OUTPUT CURRENT WILL BE REDUCED. SEE AN44

LT1074 • TA02

Positive-to-Negative Converter with 5V Output



* = 1% FILM RESISTORS
 D1 = MOTOROLA-MBR745
 C1 = NICHICON-UPL1C221MRH6
 C2 = NICHICON-UPL1A102MRH6
 L1 = COILTRONICS-CTX25-5-52

† LOWER REVERSE VOLTAGE RATING MAY BE USED FOR LOWER INPUT VOLTAGES.
 LOWER CURRENT RATING IS ALLOWED FOR LOWER OUTPUT CURRENT. SEE AN44.
 †† LOWER CURRENT RATING MAY BE USED FOR LOWER OUTPUT CURRENT. SEE AN44.

** R1, R2, AND C4 ARE USED FOR LOOP FREQUENCY COMPENSATION WITH LOW INPUT VOLTAGE,
 BUT R1 AND R2 MUST BE INCLUDED IN THE CALCULATION FOR OUTPUT VOLTAGE DIVIDER VALUES.
 FOR HIGHER OUTPUT VOLTAGES, INCREASE R1, R2, AND R3 PROPORTIONATELY.
 FOR INPUT VOLTAGE > 10V, R1, R2, AND C4 CAN BE ELIMINATED, AND COMPENSATION IS
 DONE TOTALLY ON THE V_C PIN.
 $R3 = V_{OUT} - 2.37 (K\Omega)$
 $R1 = (R3) (1.86)$
 $R2 = (R3) (3.65)$

** MAXIMUM OUTPUT CURRENT OF 1A IS DETERMINED BY MINIMUM INPUT
 VOLTAGE OF 4.5V. HIGHER MINIMUM INPUT VOLTAGE WILL ALLOW MUCH HIGHER
 OUTPUT CURRENTS. SEE AN44.

LT1074 • TA03

PACKAGE DESCRIPTION



PACKAGE DESCRIPTION

R Package
7-Lead Plastic DD Pak
 (Reference LTC DWG # 05-08-1462)

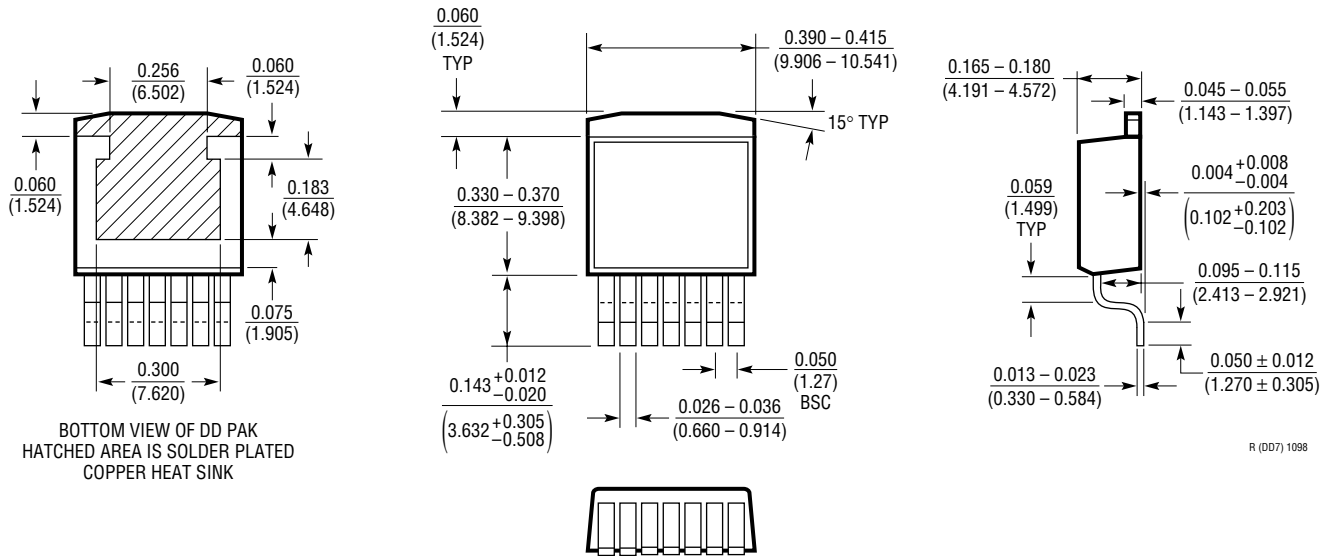

T Package
5-Lead Plastic TO-220 (Standard)
 (Reference LTC DWG # 05-08-1421)

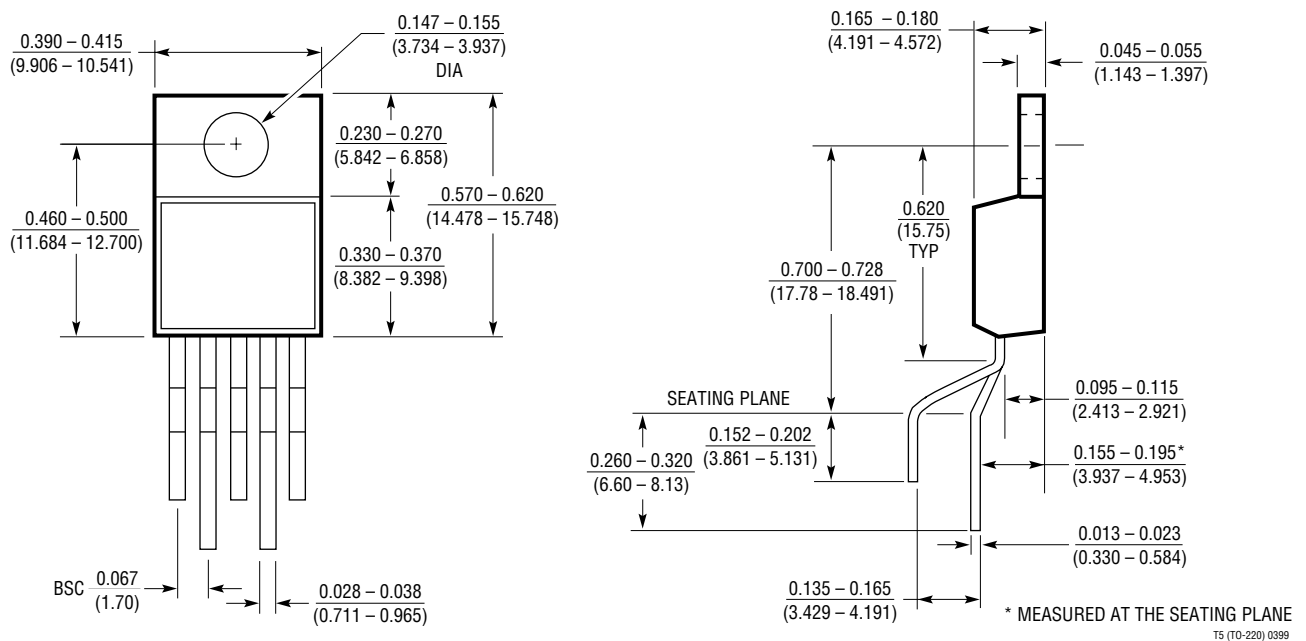

TYPICAL APPLICATION



PACKAGE DESCRIPTION

T7 Package
7-Lead Plastic TO-220 (Standard)
 (Reference LTC DWG # 05-08-1422)



RELATED PARTS

PART NUMBER	DESCRIPTION	COMMENTS
LT1375/LT1376	1.5A, 500kHz Step-Down Switching Regulators	V _{IN} Up to 25V, I _{OUT} Up to 1.25A, SO-8
LT1374/LT1374HV	4.5A, 500kHz Step-Down Switching Regulators	V _{IN} Up to 25V (32V for HV), I _{OUT} Up to 4.25A, SO-8/DD
LT1370	6A, 500kHz High Efficiency Switching Regulator	6A/42V Internal Switch, 7-Lead DD/TO-220
LT1676	Wide Input Range, High Efficiency Step-Down Regulator	V _{IN} from 7.4V to 60V, I _{OUT} Up to 0.5A, SO-8
LT1339	High Power Synchronous DC/DC Controller	V _{IN} Up to 60V, I _{OUT} Up to 50A, Current Mode
LT1765	3A, 1.25MHz, Step-Down Regulator	V _{IN} = 3V to 25V, V _{µF} = 1.2V, TSSOP-16E, S08 Package

sn1074 1074fds