

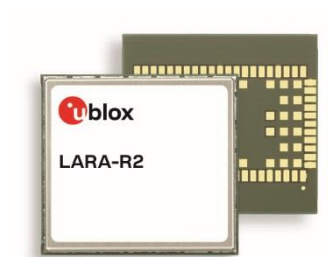

LARA-R2 series

Size-optimized LTE Cat 1 modules in single and multi-mode configurations

Data sheet



Abstract

Technical data sheet describing the LARA-R2 series multi-mode cellular modules. The modules are a cost efficient and performance optimized LTE Cat 1 / 3G / 2G multi-mode solution covering up to four LTE bands, up to two UMTS/HSPA bands and up to two GSM/EGPRS bands in the very small and compact LARA form factor.

Document information

Title	LARA-R2 series	
Subtitle	Size-optimized LTE Cat 1 modules in single and multi-mode configurations	
Document type	Data sheet	
Document number	UBX-16005783	
Revision and date	R28	23-Jun-2021
Disclosure restriction	C1-Public	

Product status	Corresponding content status	
Functional sample	Draft	For functional testing. Revised and supplementary data will be published later.
In development / Prototype	Objective specification	Target values. Revised and supplementary data will be published later.
Engineering sample	Advance information	Data based on early testing. Revised and supplementary data will be published later.
Initial production	Early production information	Data from product verification. Revised and supplementary data may be published later.
Mass production / End of life	Production information	Document contains the final product specification.

This document applies to the following products:

Product name	Type number	Modem version	Application version	PCN reference	Product status
LARA-R202	LARA-R202-02B-00	30.42	A01.00	UBX-17057959	Obsolete
	LARA-R202-02B-01	30.42	A01.01	UBX-18018067	Obsolete
	LARA-R202-02B-02	30.42	A01.02	UBX-18057549	Obsolete
	LARA-R202-02B-03	30.44	A01.02	UBX-19011731	End of life
	LARA-R202-02B-04	30.44	A01.02	UBX-21008753	Mass production
	LARA-R202-82B-00	30.53	A01.03	UBX-19043497	End of life
	LARA-R202-82B-01	30.53	A01.03	UBX-21008753	Mass production
	LARA-R202-03B-00	30.55	A01.00	UBX-20027523	Mass production
LARA-R203	LARA-R203-02B-00	30.39	A01.00	UBX-17048311	Obsolete
	LARA-R203-02B-01	30.39	A01.02	UBX-18018067	Obsolete
	LARA-R203-02B-02	30.39	A01.03	UBX-18057549	Obsolete
	LARA-R203-02B-03	30.41	A01.03	UBX-19011731	End of life
	LARA-R203-02B-04	30.41	A01.03	UBX-21013811	Mass production
	LARA-R203-02B-34	30.54	A01.00	UBX-19056532	End of life
	LARA-R203-02B-35	30.54	A01.00	UBX-21013810	Mass production
	LARA-R203-03B-00	30.55	A01.00	UBX-20027523	Mass production
LARA-R204	LARA-R204-02B-00	31.34	A01.00	UBX-17012269	Obsolete
	LARA-R204-02B-02	31.40	A01.00	UBX-18046834	Mass production
LARA-R211	LARA-R211-02B-00	30.31	A01.00	UBX-17012270	Obsolete
	LARA-R211-02B-01	30.49	A01.01	UBX-17054295	Obsolete
	LARA-R211-02B-02	30.49	A01.02	UBX-18057549	End of life
	LARA-R211-02B-03	30.49	A01.05	UBX-20012865	End of life
	LARA-R211-02B-04	30.49	A01.05	UBX-21013808	Mass production
LARA-R220	LARA-R220-62B-00	30.44	A01.03	UBX-17061668	Obsolete
	LARA-R220-62B-01	30.44	A01.04	UBX-18050698	Obsolete
	LARA-R220-62B-02	30.44	A01.05	UBX-18057549	Obsolete
	LARA-R220-62B-03	30.44	A01.07	UBX-19029271	Mass production
LARA-R280	LARA-R280-02B-00	30.43	A01.01	UBX-17063950	Obsolete
	LARA-R280-02B-01	30.43	A01.02	UBX-18018067	Obsolete
	LARA-R280-02B-02	30.43	A01.03	UBX-18052020	Obsolete
	LARA-R280-02B-03	30.43	A01.04	UBX-18057549	End of life
	LARA-R280-02B-04	30.43	A01.06	UBX-19029271	Mass production
LARA-R281	LARA-R281-02B-00	30.49	A01.06	UBX-20035136	Mass production

u-blox or third parties may hold intellectual property rights in the products, names, logos and designs included in this document. Copying, reproduction, modification or disclosure to third parties of this document or any part thereof is only permitted with the express written permission of u-blox.

The information contained herein is provided "as is" and u-blox assumes no liability for its use. No warranty, either express or implied, is given, including but not limited to, with respect to the accuracy, correctness, reliability and fitness for a particular purpose of the information. This document may be revised by u-blox at any time without notice. For the most recent documents, visit www.u-blox.com.

Copyright © u-blox AG.

Contents

Document information	2
Contents	4
1 Functional description	6
1.1 Overview.....	6
1.2 Product features.....	7
1.3 Block diagram.....	8
1.4 Product description.....	8
1.5 AT command support.....	10
1.6 Supported features.....	10
2 Interfaces	12
2.1 Power management.....	12
2.1.1 Module supply input (VCC).....	12
2.1.2 RTC supply input/output (V_BCKP).....	12
2.1.3 Generic digital interfaces supply output (V_INT).....	12
2.2 Antenna interfaces.....	12
2.2.1 Antenna RF interfaces.....	12
2.2.2 Antenna detection.....	12
2.3 System functions.....	13
2.3.1 Module power-on.....	13
2.3.2 Module power-off.....	13
2.3.3 Module reset.....	14
2.3.4 Module/host configuration selection.....	14
2.4 SIM.....	14
2.4.1 SIM interface.....	14
2.4.2 SIM detection.....	14
2.5 Serial communication.....	15
2.5.1 Main UART interface.....	15
2.5.2 Auxiliary UART interface.....	16
2.5.3 USB interface.....	17
2.5.4 HSIC interface.....	18
2.5.5 DDC (I2C) interface.....	18
2.5.6 SDIO interface.....	18
2.6 Audio.....	18
2.7 Clock output.....	19
2.8 GPIO.....	19
3 Pin definition	20
3.1 Pin assignment.....	20
4 Electrical specifications	25
4.1 Absolute maximum rating.....	25
4.1.1 Maximum ESD.....	25
4.2 Operating conditions.....	26

4.2.1	Operating temperature range.....	26
4.2.2	Supply/power pins	26
4.2.3	Current consumption.....	27
4.2.4	LTE RF characteristics	28
4.2.5	3G RF characteristics	30
4.2.6	2G RF characteristics	30
4.2.7	ANT_DET pin.....	31
4.2.8	PWR_ON pin.....	31
4.2.9	RESET_N pin	31
4.2.10	SIM pins	31
4.2.11	USB pins	32
4.2.12	HSIC pins	32
4.2.13	DDC (I2C) pins.....	32
4.2.14	Generic Digital Interfaces pins	33
4.3	Parameters for ATEX applications.....	35
5	Mechanical specifications	36
6	Qualification and approvals.....	37
6.1	Reliability tests.....	37
6.2	Approvals.....	37
7	Product handling & soldering.....	38
7.1	Packaging	38
7.1.1	Reels	38
7.1.2	Tapes.....	39
7.2	Moisture sensitivity levels.....	40
7.3	Reflow soldering	40
7.4	ESD precautions.....	40
8	Default settings	41
9	Labeling and ordering information	42
9.1	Product labeling.....	42
9.2	Explanation of codes	43
9.3	Ordering information.....	44
Appendix	45
A	Glossary	45
Related documentation	46
Revision history	47
Contact	48

1 Functional description

1.1 Overview

The LARA-R2 series comprises LTE Cat 1 / 3G / 2G multi-mode modules in the very small LARA LGA form-factor (26.0 x 24.0 mm, 100-pin) that are easy to integrate in compact designs.

LARA-R2 series modules support multi-band LTE-FDD Cat 1 radio access technology with seven regional variants. Each variant is designed for specific regional market requirements to allow development of cost efficient yet feature-rich products. The variants with 2G or 3G fallback provide connectivity in cases where LTE coverage is not yet available. This allows seamless operation during technology transition.

LARA modules are form-factor compatible with u-blox SARA, LISA and TOBY cellular module families: this facilitates easy migration from u-blox GSM/GPRS, CDMA, UMTS/HSPA, and other LTE modules, maximizes the investments of customers, simplifies logistics, and enables very short time-to-market.

The modules are ideal for applications that are transitioning to LTE from 2G and 3G, due to the long term availability and scalability of LTE networks.

With a range of interface options and an integrated IP stack, the modules are designed to support a wide range of data-centric applications. The unique combination of performance and flexibility make these modules ideally suited for medium speed M2M applications, such as smart energy gateways, remote access video cameras, digital signage, telehealth and telematics.

LARA-R2 series modules include product versions supporting Voice over LTE (VoLTE) and voice over 3G or 2G (CSFB) for applications that require voice, such as security and surveillance systems.

Thanks to the u-blox's CellLocate[®] technology, LARA-R2 series modules offer cost-effective location estimation based on information from surrounding cellular base stations. A positioning solution with CellLocate[®] and a u-blox GNSS module provides redundancy and accuracy that can be beneficial for numerous applications.

The temperature range of -40 °C to +85 °C guarantees operation in harsh environments and in very compact designs.

LARA-R2 modules are manufactured in ISO/TS 16949 certified sites, with the highest production standards and the highest quality and reliability. Each module is fully tested and inspected during production. Modules are qualified according to ISO 16750 – for systems installed in vehicles.

USB drivers and RIL software for Android are free of charge.

1.2 Product features

Model	Region	Radio access technology	Positioning	Interfaces	Audio	Features	Grade
		LTE bands ¹ UMTS bands GSM bands	GNSS via modem AssistNow Software CellLocate®	UART USB 2.0 HISC * SDIO * DDC (I ² C) GPIOs	Analog audio Digital audio	Network indication VoLTE Antenna supervisor Embedded TCP/UDP stack Embedded HTTP,FTP,TSL FW update via serial FOTA client Rx Diversity Dual stack IPv4 / IPv6	Standard Professional Automotive
LARA-R202	North America	2,4 850 5,12 1900	• • •	2 ² 1 1 1 1 9	•	• • ³ • • • • • • • • •	•
LARA-R203	North America	2,4,12	• • •	2 ² 1 1 1 1 9	•	• • ³ • • • • • • • • •	•
LARA-R204	North America	4,13		1 1 1 1 1 9		• • • • • • • • •	•
LARA-R211	EMEA	3,7,20 900 1800	• ⁴ • ⁴ • ⁴	2 ⁵ 1 1 1 1 9	•	• • • • • • • • •	•
LARA-R220	Japan	1,19	• • •	1 1 1 1 1 9		• • • • • • • • •	•
LARA-R280	APAC	3,8,28 2100	• • •	1 1 1 1 1 9	•	• ■ • • • • • • • •	•
LARA-R281	EMEA	1,3,8 20,28 2100	• • •	1 1 1 1 1 9	•	• ■ • • • • • • • •	•

• = Available in any firmware

■ = CSFB only

* = HW ready

Table 1: LARA-R2 series main features summary

¹ LTE band 12 is a superset including band 17: LTE band 12 is supported along with Multi-Frequency Band Indicator (MFBI)

² Second UART not supported by LARA-R202-02B, LARA-R202-82B, or LARA-R203-02B product versions

³ AT&T certified with VoLTE

⁴ External GNSS control via modem, AssistNow Software and CellLocate® are not supported by LARA-R211-02B-00

⁵ Second UART is not supported by LARA-R211-02B-00, LARA-R211-02B-01, or LARA-R211-02B-02 product versions

1.3 Block diagram

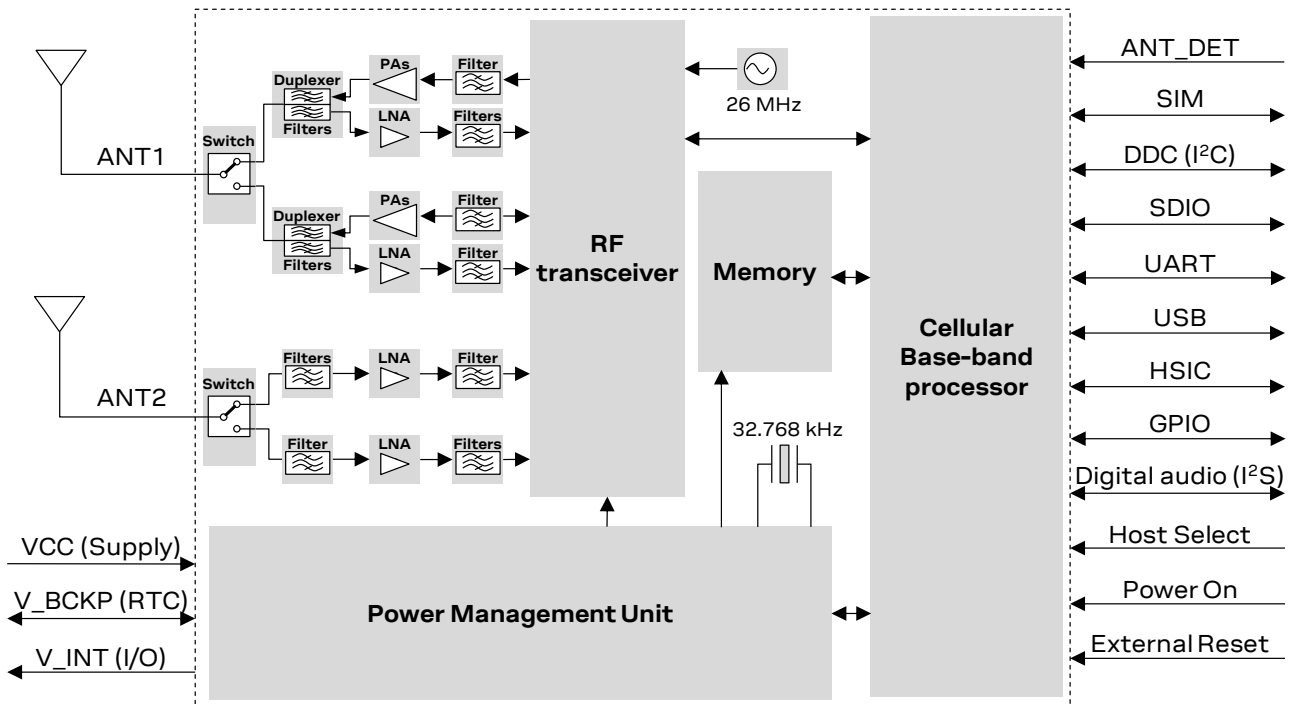

Figure 1: LARA-R2 series block diagram

The "02B", "62B", "82B", and "03B" product versions of u-blox LARA-R2 series modules (meaning the LARA-R202-02B, LARA-R202-82B, LARA-R202-03B, the LARA-R203-02B, LARA-R203-03B, the LARA-R204-02B, the LARA-R211-02B, the LARA-R220-62B, the LARA-R280-02B, and the LARA-R281-02B) do not support the following interfaces, which can be left unconnected and should not be driven by external devices:

- HSIC interface
- SDIO interface
- HOST_SELECT pin

1.4 Product description

LARA-R2 series modules provide LTE Cat 1 radio access technology, some variants with 2G or 3G multi-mode fallback.

- LARA-R202 is designed mainly for operation in America (on LTE and 3G networks)
- LARA-R203 is designed mainly for operation in America (on LTE networks)
- LARA-R204 is designed mainly for operation in America (on Verizon LTE network)
- LARA-R211 is designed mainly for operation in EMEA on LTE and 2G networks
- LARA-R220 is designed mainly for operation in Japan (on NTT DoCoMo LTE network)
- LARA-R280 is designed mainly for operation in APAC on LTE and 3G networks
- LARA-R281 is designed mainly for operation in EMEA on LTE and 3G networks

4G LTE	3G UMTS/HSDPA/HSUPA	2G GSM/GPRS/EDGE
3GPP Release 9	3GPP Release 9	3GPP Release 9
Long Term Evolution (LTE)	High Speed Packet Access (HSPA)	Enhanced Data rate GSM Evolution (EDGE)
Evolved UTRA (E-UTRA)	UMTS Terrestrial Radio Access (UTRA)	GSM EGPRS Radio Access (GERA)
Frequency Division Duplex (FDD)	Frequency Division Duplex (FDD)	Time Division Multiple Access (TDMA)
DL Rx diversity	DL Rx Diversity	DL Advanced Rx Performance Phase 1
Band support ⁶ :	Band support:	Band support:
<ul style="list-style-type: none"> • LARA-R202: <ul style="list-style-type: none"> • Band 12 (700 MHz)⁷ • Band 5 (850 MHz) • Band 4 (1700 MHz) • Band 2 (1900 MHz) • LARA-R203: <ul style="list-style-type: none"> • Band 12 (700 MHz)⁷ • Band 4 (1700 MHz) • Band 2 (1900 MHz) • LARA-R204: <ul style="list-style-type: none"> • Band 13 (700 MHz) • Band 4 (1700 MHz) • LARA-R211: <ul style="list-style-type: none"> • Band 20 (800 MHz) • Band 3 (1800 MHz) • Band 7 (2600 MHz) • LARA-R220: <ul style="list-style-type: none"> • Band 19 (850 MHz) • Band 1 (2100 MHz) • LARA-R280: <ul style="list-style-type: none"> • Band 28 (700 MHz) • Band 8 (900 MHz) • Band 3 (1800 MHz) • LARA-R281: <ul style="list-style-type: none"> • Band 28 (700 MHz) • Band 20 (800 MHz) • Band 8 (900 MHz) • Band 3 (1800 MHz) • Band 1 (2100 MHz) 	<ul style="list-style-type: none"> • LARA-R202: <ul style="list-style-type: none"> • Band 5 (850 MHz) • Band 2 (1900 MHz) • LARA-R280: <ul style="list-style-type: none"> • Band 1 (2100 MHz) • LARA-R281: <ul style="list-style-type: none"> • Band 1 (2100 MHz) 	<ul style="list-style-type: none"> • LARA-R211: <ul style="list-style-type: none"> • E-GSM 900 MHz • DCS 1800 MHz
LTE Power Class	UMTS/HSDPA/HSUPA Power Class	GSM/GPRS (GMSK) Power Class
<ul style="list-style-type: none"> • Power Class 3 (23 dBm) 	<ul style="list-style-type: none"> • Class 3 (24 dBm) 	<ul style="list-style-type: none"> • Power Class 4 (33 dBm) for E-GSM band • Power Class 1 (30 dBm) for DCS band
		EDGE (8-PSK) Power Class
		<ul style="list-style-type: none"> • Power Class E2 (27 dBm) for E-GSM band • Power Class E2 (26 dBm) for DCS band
Data rate	Data rate	Data rate ⁸
<ul style="list-style-type: none"> • LTE category 1: up to 10.3 Mbit/s DL, up to 5.2 Mbit/s UL 	<ul style="list-style-type: none"> • HSDPA category 8: up to 7.2 Mbit/s DL • HSUPA category 6: up to 5.76 Mbit/s UL 	<ul style="list-style-type: none"> • GPRS multi-slot class 33⁹, CS1-CS4, up to 107 kbit/s DL, up to 85.6 kbit/s UL • EDGE multi-slot class 33⁹, MCS1-MCS9, up to 296 kbit/s DL, up to 236.8 kbit/s UL

Table 2: LARA-R2 series LTE, 3G and 2G characteristics

LARA-R2 modules provide Voice over LTE (VoLTE)¹⁰ as well as Circuit-Switched-Fall-Back (CSFB)¹¹ audio capability.

⁶ LARA-R2 modules support all E-UTRA channel bandwidths for each operating band according to 3GPP TS 36.521-1 [11]

⁷ LTE band 12 is a superset including band 17: LTE band 12 is supported along with Multi-Frequency Band Indicator feature

⁸ GPRS/EDGE multislot class determines the number of timeslots available for upload and download and thus the speed at which data can be transmitted and received, with higher classes typically allowing faster data transfer rates.

⁹ GPRS/EDGE multislot class 33 implies a maximum of 5 slots in DL (reception), 4 slots in UL (transmission) with 6 slots in total.

¹⁰ Not supported by LARA-R204-02B, LARA-R220-62B, LARA-R280-02B and LARA-R281-02B modules product versions.

¹¹ Not supported by LARA-R203-02B, LARA-R203-03B, LARA-R204-02B and LARA-R220-62B modules product versions.

1.5 AT command support

The LARA-R2 series modules support AT commands according to 3GPP standards TS 27.007 [7], TS 27.005 [8] and the u-blox AT command extension.

 For the complete list of all supported AT commands and their syntax, see the u-blox AT commands manual [1].

RIL (Radio Interface Layer) software for Android and Embedded Windows is available for LARA-R2 series modules free of charge; see the Android RIL source code application note [3] for the supported software deliveries and more information.

1.6 Supported features

Table 3 lists some of the main features supported by LARA-R2 series. For more details, see LARA-R2 series system integration manual [2] and u-blox AT commands manual [1].

Feature	Description
Network indication	GPIO configured to indicate the network status: registered home network, registered roaming, voice or data call enabled, no service. The feature can be enabled through the +UGPIOC AT command.
Antenna detection	The ANT_DET pin provides antenna presence detection capability, evaluating the resistance from ANT1 and ANT2 pins to GND by means of an external antenna detection circuit implemented on the application board. The antenna detection feature can be enabled through the +UANTR AT command.
Embedded TCP and UDP stack	Embedded TCP/IP and UDP/IP stack including direct link mode for TCP and UDP sockets. Sockets can be set in Direct Link mode to establish a transparent end to end communication with an already connected TCP or UDP socket via serial interface.
FTP, FTPS	File Transfer Protocol as well as Secure File Transfer Protocol (SSL encryption of FTP control channel) functionalities are supported by means of AT commands.
HTTP, HTTPS	Hyper-Text Transfer Protocol and Secure Hyper-Text Transfer Protocol (SSL encryption) functions are supported via AT commands. HEAD, GET, POST, DELETE and PUT operations are available.
Embedded TLS 1.2	With the support of X.509 certificates, Embedded TLS 1.2 provides server and client authentication, data encryption, data signature and enables TCP/IP applications like HTTPS and FTPS to communicate over a secured and trusted connection. The feature can be configured and enabled by +USECMNG and +USECPRF AT commands.
DNS	Support for DNS functionality.
IPv4/IPv6 dual-stack	Can move between IPv4 and dual stack network infrastructures. IPv4 and IPv6 addresses can be used.
PPP	IPv4/IPv6 packets relaying through the cellular protocol stack performed on a Point-to-Point Protocol connection established with the external application via a serial interface (UART, MUX, or CDC-ACM). Transitions between Online command mode (OLCM) and PPP mode are supported.
BIP	Bearer Independent Protocol for Over-the-Air SIM provisioning. The data transfer to/from the SIM uses either an already active PDP context or a new PDP context established with the APN provided by the SIM card.
Multiple PDP contexts	Up to 8 PDP contexts can be activated, and multi secondary PDP contexts be associated to a primary PDP context.
VoLTE ¹² and CSFB ¹³ audio capability	Voice over LTE (VoLTE) feature allows voice service over LTE bearer, via embedded IP Multimedia Subsystem (IMS). Circuit Switched Fall-Back (CSFB) feature allows voice service over circuit switched infrastructure (3G or 2G).
Firmware update Over AT commands (FOAT)	Firmware module update over AT command interfaces. The feature can be enabled and configured through the +UFWUPD AT command.
Firmware update Over The Air (FOTA)	Embedded FOTA client to enable the Firmware module update over the cellular air interface. The feature can be enabled and configured through the +UFWINSTALL AT command.

¹² Not supported by LARA-R204-02B, LARA-R220-62B, LARA-R280-02B and LARA-R281-02B modules product version.

¹³ Not supported by LARA-R203-02B, LARA-R203-03B, LARA-R204-02B, and LARA-R220-62B modules product version.



Feature	Description
LTE / 3G Rx Diversity	Improved cellular link quality and reliability on all operating bands, by means of 2 receiving antenna inputs.
GNSS via modem ¹⁴	Full access to u-blox positioning chips and modules is available through a dedicated DDC (I2C) interface. This means that from any host processor, a single serial port can control the cellular module and the u-blox M8 positioning chip or module. For more details, see the GNSS implementation application note [4].
Embedded AssistNow Software ¹⁴	Embedded AssistNow Online and AssistNow Offline clients are available to provide better GNSS performance and faster Time-to-First-Fix. An AT command can enable / disable the clients.
CellLocate ^{®14}	Enables the estimation of device position based on the parameters of the mobile network cells visible to the specific device based on the CellLocate [®] database: <ul style="list-style-type: none"> • Normal scan: only the parameters of the visible home network cells are sent CellLocate [®] is available via a set of AT commands for CellLocate [®] service configuration and position request.
Hybrid Positioning ¹⁴	The current module position is provided by a u-blox positioning chip or module or the estimated position from CellLocate [®] depending on which method provides the best and fastest solution according to the user configuration. Hybrid positioning is available via a set of AT commands that allow the configuration and the position request.
Wi-Fi via modem ¹⁵	Full access to Wi-Fi modules is available through a dedicated SDIO interface. This means that from any host processor a single serial port can control the cellular module and the short range communication module.
DTMF decoder ¹⁶	During a voice call, the Dual-Tone Multi-Frequency detector analyses the RX speech (coming from remote party). The detected DTMF symbols can be output via the related URC. The feature can be enabled and configured through the +UDTMFCFG +UDTMFD AT command.
In-Band Modem ¹⁵	In-Band modem solution for eCall and ERA-GLONASS emergency call applications over cellular networks implemented according to the 3GPP TS 26.267 specification [10]. When activated, the in-vehicle eCall / ERA-GLONASS system (IVS) creates an emergency call carrying both voice and data (including vehicle position data) directly to the nearest Public Safety Answering Point (PSAP) to determine whether rescue services should be dispatched to the known position.
Smart Temperature Supervisor	Constant monitoring of the module board temperature: <ul style="list-style-type: none"> • Warning notification when the temperature approaches an upper or lower predefined threshold • Shutdown notified and forced when the temperature value is outside the specified range (shutdown suspended in case of an emergency call in progress) This feature can be enabled and configured via the +USTS AT command.  The sensor measures the board temperature, which can differ from ambient temperature.
Power saving	The power saving configuration is disabled by default, but it can be enabled and configured using the +UPSV AT command. When the power saving is enabled, the module automatically enters the low power idle-mode whenever possible, reducing current consumption. During idle-mode, the module processor core runs with the RTC 32 kHz reference clock, which is generated by the internal 32 kHz oscillator.
Fast Dormancy	The Fast Dormancy feature, defined in 3GPP Rel.8, allows reduction of current consumption and network utilization during periods of data inactivity. It can be activated and configured by +UFDAC and +UDCONF=61 AT commands.
LTE cDRX	Both the Long DRX Cycle and the Short DRX cycle are supported for LTE Connected Discontinuous Reception, allowing reduction of current consumption and LTE network utilization during periods of data inactivity.
ODIS ¹⁷	OMA-DM IMEI Sync (ODIS) is an AT&T functionality required at the cellular module level and used to identify the end device operating inside the network.

Table 3: Some of the main features supported by LARA-R2 series modules

 u-blox is extremely mindful of user privacy. When a position is sent to the CellLocate[®] server, u-blox is unable to track the SIM used or the specific device.

¹⁴ Not supported by LARA-R204-02B, LARA-R211-02B-00 product versions.

¹⁵ Not supported by "02B", "62B", "82B", and "03B" product versions.

¹⁶ Not supported by LARA-R202-82B, LARA-R204-02B, and LARA-R220-62B modules product version.

¹⁷ Not supported by "03B" product version and LARA-R203-02B-34

2 Interfaces

2.1 Power management

2.1.1 Module supply input (VCC)

LARA-R2 series modules must be supplied through the three **VCC** pins by a DC power supply. Voltage must be stable, because during operation the current drawn from **VCC** can vary by some order of magnitude, especially due to the surging consumption profile of the GSM system (described in the LARA-R2 series system integration manual [2]). It is important that the system power supply circuit is able to support peak power.

LARA-R211 modules provide separate supply inputs over the three **VCC** pins:

- **VCC** pins #52 and #53 represent the supply input for the internal RF power amplifier, demanding most of the total current drawn of the module when RF transmission is enabled during a voice/data call
- **VCC** pin #51 represents the supply input for the internal baseband Power Management Unit and the internal transceiver, demanding a minor part of the total current drawn of the module when RF transmission is enabled during a voice/data call

2.1.2 RTC supply input / output (V_BCKP)

When **VCC** voltage is within the valid operating range, the internal Power Management Unit (PMU) supplies the Real Time Clock (RTC) and the same supply voltage is available on the **V_BCKP** pin. If the **VCC** voltage is under the minimum operating limit (e.g. during not powered mode), the **V_BCKP** pin can externally supply the RTC.

2.1.3 Generic digital interfaces supply output (V_INT)

LARA-R2 series modules provide a 1.8 V supply rail output on the **V_INT** pin, which is internally generated when the module is switched on. The same voltage domain is used internally to supply the generic digital interfaces of the modules. The **V_INT** supply output can be used in place of an external discrete regulator.

2.2 Antenna interfaces

2.2.1 Antenna RF interfaces

The modules have two RF pins with a characteristic impedance of 50 Ω . The primary antenna pin (**ANT1**) supports both Tx and Rx, providing the main antenna interface, while the secondary antenna pin (**ANT2**) supports Rx only for the LTE / 3G Rx diversity configuration.

2.2.2 Antenna detection

The **ANT_DET** pin is an Analog to Digital Converter (ADC) input with a current source provided by LARA-R2 modules to sense the antenna(s) presence (as an optional feature). It evaluates the resistance from **ANT1** and **ANT2** pins to GND by means of an external antenna detection circuit implemented on the application board. For more details, see the LARA-R2 series system integration manual [2] and the u-blox AT commands manual [1].

2.3 System functions

2.3.1 Module power-on

LARA-R2 series modules can be switched on in one of the following ways:

- Rising edge on the **VCC** input to a valid voltage for module supply, i.e. applying module supply: the modules switch on if the **VCC** supply is applied, starting from a voltage value of less than 2.1 V, with a rise time from 2.3 V to 2.8 V of less than 4 ms, reaching a proper nominal voltage value within **VCC** operating range.

Alternately, for example if the fast rise time on **VCC** rising edge cannot be guaranteed by the application, the LARA-R2 series module can be switched on from not-powered mode as follows:

- **RESET_N** input pin is held low by the external application during the **VCC** rising edge, so that the module will switch on when the external application releases the **RESET_N** input pin from the low logic level, after the **VCC** supply voltage stabilizes at its proper nominal value within the operating range
- **PWR_ON** input pin is held low by the external application during the **VCC** rising edge, so that the module will switch on when the external application releases the **PWR_ON** input pin from the low logic level, after the **VCC** supply voltage stabilizes at its proper nominal value within the operating range

When the LARA-R2 series modules are in the power-off mode (i.e. properly switched off as described in section 2.3.2, with valid **VCC** module supply applied), they can be switched on as following:

- Low pulse on the **PWR_ON** pin, which is normally set high by an internal pull-up, for a valid time period (see section 4.2.8). The **PWR_ON** line should be driven by open drain, open collector or contact switch.
- Rising edge on the **RESET_N** pin, i.e. releasing the pin from the low level, normally set high by an internal pull-up. The **RESET_N** line should be driven by open drain, open collector or contact switch.
- RTC alarm, i.e. pre-programmed scheduled time by +CALA AT command.

2.3.2 Module power-off

LARA-R2 series can be properly switched off, saving current parameter settings in the module's non-volatile memory and performing a proper network detach, by:

- AT+CPWROFF command (see the u-blox AT commands manual [1]).
- Low pulse on the **PWR_ON** pin, which is normally set high by an internal pull-up, for a valid time period (see section 4.2.8). The **PWR_ON** line should be driven by open drain, open collector or contact switch.

An abrupt under-voltage shutdown occurs on LARA-R2 series modules when the **VCC** supply is removed. If this occurs, it is not possible to store the current parameter settings in the module's non-volatile memory or to perform the proper network detach.

An abrupt shutdown occurs on LARA-R2 series modules when a low level is applied on the **RESET_N** pin, which is normally set high by an internal pull-up. If this occurs, it is not possible to store the current parameter settings in the module's non-volatile memory and to perform the proper network detach.

An over-temperature or an under-temperature shutdown occurs on LARA-R2 modules when the temperature measured within the cellular module reaches the dangerous area, if the optional Smart Temperature Supervisor feature is enabled and configured by the dedicated AT command. For more details, see the LARA-R2 series system integration manual [2] and the u-blox AT commands manual [1], +USTS AT command.

2.3.3 Module reset

LARA-R2 series modules can be reset (rebooted) by:

- AT+CFUN command (see the u-blox AT commands manual [1]). This causes an “internal” or “software” reset of the module. The current parameter settings are saved in the module’s non-volatile memory and a proper network detach is performed.

An abrupt “external” or “hardware” reset occurs when a low level is applied to the **RESET_N** pin, which is normally set high by an internal pull-up, for a valid time period (see the section 4.2.9). This causes an “external” or “hardware” reset of the entire module, including the integrated power management unit, except for the RTC internal block: the **V_INT** generic digital interfaces supply is switched off and all the digital pins are tri-stated, but the **V_BCKP** supply and the RTC block are enabled. The current parameter settings are not saved in the module’s non-volatile memory and a proper network detach is not performed. The **RESET_N** line should be driven by open drain, open collector or contact switch.

2.3.4 Module / host configuration selection

 The functionality of the **HOST_SELECT** pin is not supported by any current product versions.

The modules include one pin (**HOST_SELECT**) to select the module / host application processor configuration: the pin is available to select, enable, connect, disconnect and subsequently reconnect the HSIC interface.

2.4 SIM

2.4.1 SIM interface

A SIM card interface is provided on the **VSIM**, **SIM_IO**, **SIM_CLK**, **SIM_RST** pins: the high-speed SIM/ME interface is implemented as well as the automatic detection of the required SIM supporting voltage.

Both 1.8 V and 3 V SIM types are supported (1.8 V and 3 V ME). Activation and deactivation with automatic voltage switch from 1.8 V to 3 V is implemented, according to ISO-IEC 7816-3 specifications. The SIM driver supports the PPS procedure for baud-rate selection, according to the values proposed by the SIM card/chip.

2.4.2 SIM detection

LARA-R2 series modules provide the SIM detection function over the **GPIO5** pin to sense the SIM card physical presence (as an optional feature) when the pin of the module is properly connected to the mechanical switch of the SIM card holder. For more details, see the LARA-R2 series system integration manual [2].

2.5 Serial communication

LARA-R2 series modules provide the following serial communication interfaces:

- Main UART interface: serial interface available for the communication with a host application processor (AT commands, data, FW update by means of FOAT), for FW update by means of the u-blox EasyFlash tool and for diagnostic.
- Auxiliary UART interface: serial interface available for AT commands communication with a host application processor, and for diagnostic.
- USB interface: Universal Serial Bus 2.0 compliant interface available for the communication with a host application processor (AT commands, data communication, FW update by means of the FOAT feature), for FW update by means of the u-blox EasyFlash tool and for diagnostic.
- HSIC interface: High-Speed Inter-Chip USB compliant interface available for the communication with a host application processor (AT commands, data communication, FW update by means of the FOAT feature), for FW update by means of the u-blox EasyFlash tool and for diagnostic.
- DDC interface: I2C bus compatible interface available for the communication with u-blox GNSS positioning chips/modules and with external I2C devices as an audio codec.
- SDIO interface: Secure Digital Input Output interface available for the communication with compatible u-blox short range radio communication Wi-Fi modules.

2.5.1 Main UART interface

LARA-R2 series modules include a 9-wire unbalanced main primary Universal Asynchronous Receiver/Transmitter serial interface (UART) for communication with an external application host processor (AT commands, data communication, FW update by means of the FOAT feature), for FW update by means of the u-blox EasyFlash tool and for diagnostic.

UART features are:

- Complete serial port with RS-232 functionality conforming to ITU-T V.24 recommendation [14], with CMOS compatible levels (0 V for low data bit / ON state, 1.8 V for high data bit / OFF state)
- Data lines (**RXD** output, **TXD** input), hardware flow control lines (**CTS** output, **RTS** input), modem status and control lines (**DTR** input, **DSR** output, **DCD** output, **RI** output) are provided
- Hardware flow control (default value), software flow control, or none flow control are supported
- Power saving indication available on the hardware flow control output (**CTS** line): the line is driven to the OFF state when the module is not prepared to accept data by the UART interface
- Power saving control over the **RTS** input or the **DSR** input can be enabled via AT+UPSV command (see the u-blox AT commands manual [1] and LARA-R2 series system integration manual [2])
- The following baud rates are supported: 9'600, 19'200, 38'400, 57'600, 115'200 (default baud rate when autobauding is disabled), 230'400, 460'800, 921'600, 3'000'000, 3'250'000, 6'000'000 and 6'500'000 bit/s
- One-shot autobauding is supported and it is enabled by default: automatic baud rate detection is performed only once, at module start up. After the detection, the module works at the fixed baud rate (the detected one) and the baud rate can only be changed via AT command (see the u-blox AT commands manual [1], +IPR).
- The following frame formats are supported: 8N2, 8N1 (default format when automatic frame recognition is disabled), 8E1, 8O1, 7E1 and 7O1.
- One-shot automatic frame recognition is supported and it is enabled by default in conjunction with automatic baud rate detection (autobauding): the detection is performed only once, at module start up. After the detection, the module works at the detected frame format and it can only be changed via AT command (see u-blox AT commands manual [1], +ICF).

The main primary UART serial interface can be conveniently configured through AT commands: see the u-blox AT commands manual [1] (+IPR, +ICF, +IFC, &K, \Q, +UPSV, +USIO AT commands) and LARA-R2 series system integration manual [2].

2.5.1.1 Multiplexer protocol

LARA-R2 series modules include multiplexer functionality as per 3GPP TS 27.010 [9] on the main primary UART physical link. This is a data link protocol which uses HDLC-like framing and operates between the module (DCE) and the application processor (DTE), allowing a number of simultaneous sessions over the physical link (main primary UART): the user can concurrently use AT interface on one MUX channel and data communication on another MUX channel.

The following virtual channels are available (see the Mux implementation application note [5]):

- Channel 0: Multiplexer control
- Channel 1 – 5: AT commands / data connection
- Channel 6: GNSS data tunneling

 GNSS data tunneling is not supported by LARA-R204-02B, LARA-R211-02B-00 product versions.

2.5.2 Auxiliary UART interface

 The auxiliary UART interface is not supported by the "02B", "62B" and "82B" product versions of the LARA-R202, LARA-R203, LARA-R204, LARA-R220, LARA-R280, and LARA-R281 modules, and by the "02B-00", "02B-01" and "02B-02" product versions of LARA-R211 modules.

LARA-R2 series modules include a 3-wire unbalanced auxiliary secondary Universal Asynchronous Receiver/Transmitter serial interface (AUX UART) for AT commands communication with an external application host processor, and for diagnostic (CSD or PSD are not supported).

The auxiliary secondary UART interface is disabled by default, and it can be enabled by dedicated AT command (see the u-blox AT commands manual [1], +USIO) as alternative function of the DDC (I2C) interface' pins, in mutually exclusive way with the DDC (I2C) interface.

AUX UART features are:

- 3-wire serial port with RS-232 functionality conforming to ITU-T V.24 recommendation [14], with CMOS compatible signal levels (0 V for low data bit / ON state, 1.8 V for high data bit / OFF state)
- Data lines (**SCL** pin as AUX UART data output, **SDA** pin as AUX UART data input)
- Software flow control, or none flow control (default value) are supported
- The following baud rates are supported: 9'600, 19'200, 38'400, 57'600, 115'200 (default baud rate when autobauding is disabled), 230'400, 460'800, 921'600, 3'000'000, 3'250'000, 6'000'000 and 6'500'000 bit/s
- One-shot autobauding is supported and it is enabled by default: automatic baud rate detection is performed only once, at module start up. After the detection, the module works at the fixed baud rate (the detected one) and the baud rate can only be changed via AT command (see the u-blox AT commands manual [1], +IPR).
- The following frame formats are supported: 8N2, 8N1 (default format when automatic frame recognition is disabled), 8E1, 8O1, 7E1 and 7O1.
- One-shot automatic frame recognition is supported and it is enabled by default in conjunction with automatic baud rate detection (autobauding): the detection is performed only once, at module start up. After the detection, the module works at the detected frame format and it can only be changed via AT command (see u-blox AT commands manual [1], +ICF).
- The Data Terminal Ready physical line is not available, but the logical Data Terminal Ready line is always to ON state

The multiplexer protocol is not supported over the auxiliary secondary UART physical link.

The auxiliary secondary UART serial interface can be conveniently configured through AT commands: see the u-blox AT commands manual [1] (+IPR, +ICF, +IFC, &K, \Q, +UPSV, +USIO AT commands) and LARA-R2 series system integration manual [2].

2.5.3 USB interface

LARA-R2 series modules include a USB High-Speed 2.0 compliant interface with a maximum 480 Mbit/s data rate according to the Universal Serial Bus specification revision 2.0 [15]. The module itself acts as a USB device and can be connected to any compatible USB host.

The USB interface is available for communication with a host application processor (AT commands, data communication, FW update by means of the FOAT feature), for FW update by means of the u-blox EasyFlash tool and for diagnostics.

The **USB_D+** / **USB_D-** lines carry the USB data and signaling. The USB interface is automatically enabled by an external valid USB VBUS supply voltage (5.0 V typical) applied on the **VUSB_DET** pin.

The USB interface of LARA-R2 series modules makes several USB functions available with various capabilities and purposes, such as:

- CDC-ACM for AT commands and data communication
- CDC-ACM for GNSS tunneling
- CDC-ACM for SAP (SIM Access Profile)
- CDC-ACM for Diagnostic log
- CDC-NCM for Ethernet-over-USB

 CDC-ACM for GNSS tunneling is not supported by the LARA-R204-02B and LARA-R211-02B-00 product versions.

 CDC-ACM for SAP and CDC-NCM for Ethernet-over-USB are not supported by any current product versions.

The USB interface provides the following set of USB functions:

- 6 CDC-ACM modem COM ports enumerated as follows:
 - USB1: AT and data
 - USB2: AT and data
 - USB3: AT and data
 - USB4: GNSS tunneling
 - USB5: SAP (SIM Access Profile)
 - USB6: diagnostic log

The user can concurrently use the AT command interface on one CDC, and Packet-Switched / Circuit-Switched Data communication on another CDC.

For more details regarding USB capabilities, see the LARA-R2 series system integration manual [2].

USB drivers are available for the following Windows and Windows Embedded operating system platforms:

- Windows 7
- Windows 8
- Windows 8.1
- Windows 10
- Windows Embedded CE 6.0
- Windows Embedded Compact 7
- Windows Embedded Compact 2013
- Windows 10 IoT

LARA-R2 series modules are compatible with the standard Linux/Android USB kernel drivers.

2.5.4 HSIC interface

 The HSIC interface is not supported by current product versions, except for diagnostic purposes.

LARA-R2 series modules include a USB High-Speed Inter-Chip compliant interface with a maximum 480 Mbit/s data rate as per the High-Speed Inter-Chip USB Electrical Specification Version 1.0 [16] and USB specification revision 2.0 [15]. The module itself acts as a device and can be connected to any compatible host.

The HSIC interface is available for communication with a host application processor (AT commands, data communication, FW update by means of the FOAT feature), for FW update by means of the u-blox EasyFlash tool and for diagnostics.

The HSIC interface consists of a bi-directional DDR data line (**HSIC_DATA**) for transmitting and receiving data synchronously with the bi-directional strobe line (**HSIC_STRB**).

The modules also include the **HOST_SELECT** pin to select the module / host application processor configuration: the pin is available to select, enable, connect, disconnect and subsequently reconnect the HSIC interface.

2.5.5 DDC (I2C) interface

 Dedicated AT commands for the communication with u-blox GNSS receivers over DDC (I2C) are not supported by LARA-R204-02B and LARA-R211-02B-00 product versions.

LARA-R2 series modules include an I2C-bus compatible DDC interface (**SDA**, **SCL**)¹⁸ available to communicate with a u-blox GNSS receiver and with external I2C devices as an audio codec: LARA-R2 module acts as an I2C host which can communicate with I2C local devices in accordance with the I2C bus specifications [17].

For more details regarding DDC (I2C) interface usage and the integration with a u-blox GNSS receiver, see the LARA-R2 series system integration manual [2], GNSS implementation application note [4], and the I2C and GNSS AT commands description in the u-blox AT commands manual [1].

2.5.6 SDIO interface

 The SDIO interface is not supported by "02B", "62B", "82B", and "03B" product versions.

LARA-R2 series modules include a 4-bit Secure Digital Input Output interface (**SDIO_D0**, **SDIO_D1**, **SDIO_D2**, **SDIO_D3**, **SDIO_CLK**, **SDIO_CMD**) designed to communicate with external compatible u-blox short range radio communication Wi-Fi modules.

2.6 Audio

 Audio is not supported by LARA-R204-02B, LARA-R220-62B product versions.

LARA-R2 series modules support Voice over LTE (VoLTE) as well as Circuit-Switched Fall-Back (CSFB) from LTE to 3G or 2G radio bearer for providing audio services.

LARA-R2 series modules include a 4-wire I2S digital audio interface (**I2S_TXD**, **I2S_RXD**, **I2S_CLK**, **I2S_WA**) that can be configured by AT command in PCM mode (short synchronization signal) or in normal I2S mode (long synchronization signal) to transfer digital audio data to/from an external device as an audio codec.

¹⁸ SDA and SCL pins can be alternatively configured, in a mutually exclusive way, as auxiliary UART interface (AUX UART) on LARA-R2 series modules, except the "02B", "62B" and "82B" versions of the LARA-R202, LARA-R203, LARA-R204, LARA-R220, LARA-R280 and LARA-R281 modules, and the "02B-00", "02B-01" and "02B-02" versions of LARA-R211 modules.

For more details regarding internal audio processing system capabilities, I2S digital audio interface possible configurations, usage and guideline for the integration with an external digital audio device as an audio codec, see the LARA-R2 series system integration manual [2] and the audio sections in the u-blox AT commands manual [1].

2.7 Clock output

LARA-R2 series modules provide digital clock output functionality on the **GPIO6** pin, which can be configured to provide a 13 MHz or 26 MHz square wave. This is mainly designed to feed the clock input of an external audio codec, as the clock output can be configured in “Audio dependent” mode (generating the square wave only when the audio path is active), or in “Continuous” mode.

For more details, see the u-blox AT commands manual [1], +UMCLK AT command.

2.8 GPIO

LARA-R2 series modules include 9 pins (**GPIO1-GPIO5**, **I2S_TXD**, **I2S_RXD**, **I2S_CLK**, **I2S_WA**) that can be configured as general purpose input/output or to provide custom functions as summarized in the [Table 4](#) (for further details, see the LARA-R2 series system integration manual [2] and the GPIO section in the u-blox AT commands manual [1]).

Function	Description	Default GPIO	Configurable GPIOs
Network status indication	Network status: registered home network, registered roaming, data transmission, no service	--	GPIO1-GPIO4
GNSS supply enable ¹⁹	Enable/disable the supply of u-blox GNSS receiver connected to the cellular module	GPIO2	GPIO1-GPIO4
GNSS data ready ¹⁹	Sense when u-blox GNSS receiver connected to the module is ready for sending data by the DDC (I2C)	GPIO3	GPIO3
GNSS RTC sharing ²⁰	RTC synchronization signal to the u-blox GNSS receiver connected to the cellular module	--	GPIO4
SIM card detection	External SIM card physical presence detection	GPIO5	GPIO5
SIM card hot insertion/removal	Enable / disable SIM interface upon detection of external SIM card physical insertion / removal	--	GPIO5
I2S digital audio interface	I2S digital audio interface	I2S_RXD, I2S_TXD, I2S_CLK, I2S_WA	I2S_RXD, I2S_TXD, I2S_CLK, I2S_WA
Wi-Fi control ²⁰	Control of an external Wi-Fi chip or module	--	--
General purpose input	Input to sense high or low digital level	--	All
General purpose output	Output to set the high or the low digital level	GPIO4	All
Pin disabled	Tri-state with an internal active pull-down enabled	GPIO1	All

Table 4: GPIO custom functions configuration

¹⁹ Not supported by LARA-R204-02B and LARA-R211-02B-00 product versions: GPIO2 and GPIO3 pins are by default disabled

²⁰ Not supported by "02B", "62B", "82B", and "03B" product versions

No	Name	Power domain	I/O	Description	Remarks
7	RI	GDI	O	UART ring indicator	Circuit 125 (RI) in ITU-T V.24. Output driver class A. PU/PD class a. Value at internal reset: T/PD. See section 4.2.14 for detailed electrical specs.
8	DCD	GDI	O	UART data carrier detect	Circuit 109 (DCD) in ITU-T V.24. Output driver class A. PU/PD class a. Value at internal reset: T/PD. See section 4.2.14 for detailed electrical specs.
9	DTR	GDI	I	UART data terminal ready	Circuit 108/2 (DTR) in ITU-T V. 24. Internal active pull-up to V_INT enabled. PU/PD class a. Value at internal reset: T/PU. See section 4.2.14 for detailed electrical specs.
10	RTS	GDI	I	UART ready to send	Circuit 105 (RTS) in ITU-T V.24. Internal active pull-up to V_INT enabled. PU/PD class a. Value at internal reset: T/PU. See section 4.2.14 for detailed electrical specs.
11	CTS	GDI	O	UART clear to send	Circuit 106 (CTS) in ITU-T V.24. Output driver class A. PU/PD class a. Value at internal reset: T/PU. See section 4.2.14 for detailed electrical specs.
12	TXD	GDI	I	UART data input	Circuit 103 (TxD) in ITU-T V.24. Internal active pull-up to V_INT enabled. PU/PD class a. Value at internal reset: T/PD. See section 4.2.14 for detailed electrical specs.
13	RXD	GDI	O	UART data output	Circuit 104 (RxD) in ITU-T V.24. Output driver class A. PU/PD class a. Value at internal reset: T/PU. See section 4.2.14 for detailed electrical specs.
14	GND	-	N/A	Ground	All the GND pins must be connected to ground
15	PWR_ON	POS	I	Power-on input	Internal 10 kΩ pull-up resistor to V_BCKP. See section 4.2.8 for detailed electrical specs.
16	GPIO1	GDI	I/O	GPIO	GPIO configurable as described in section 2.8. Output driver class A. PU/PD class b. Value at internal reset: T/PD. See section 4.2.14 for detailed electrical specs.
17	VUSB_DET	VBUS	I	VBUS USB detect input	VBUS (5 V typical) USB supply generated by the host must be connected to this input pin to enable the USB interface. See section 4.2.11 for detailed electrical specs.
18	RESET_N	ERS	I	External reset input	Internal 10 kΩ pull-up resistor to V_BCKP. See section 4.2.9 for detailed electrical specs.
19	GPIO6	GDI	O	Clock output	Configurable clock output (see section 2.7). Output driver class A. PU/PD class a. Value at internal reset: T/PD. See section 4.2.14 for detailed electrical specs.
20	GND	-	N/A	Ground	All the GND pins must be connected to ground
21	HOST_SELECT	GDI	I/O	Selection of module / host processor configuration	Not supported by '02B', '62B', '82B', '03B' product versions. Output driver class A. PU/PD class a. Value at internal reset: T/PD. See section 4.2.14 for detailed electrical specs.
22	GND	-	N/A	Ground	All the GND pins must be connected to ground

No	Name	Power domain	I/O	Description	Remarks
23	GPIO2	GDI	I/O	GPIO	GPIO configurable as described in section 2.8. Output driver class A. PU/PD class a. Value at internal reset: T/PD. See section 4.2.14 for detailed electrical specs.
24	GPIO3	GDI	I/O	GPIO	GPIO configurable as described in section 2.8. Output driver class A. PU/PD class a. Value at internal reset: T/PD. See section 4.2.14 for detailed electrical specs.
25	GPIO4	GDI	I/O	GPIO	GPIO configurable as described in section 2.8. Output driver class A. PU/PD class a. Value at internal reset: T/PD. See section 4.2.14 for detailed electrical specs.
26	SDA	DDC	I/O	I2C bus data line	Fixed open drain. See section 4.2.13 for detailed electrical specs.
		GDI	I	AUX UART data input ²¹	Circuit 103 (TxD) in ITU-T V.24. Internal active pull-up to V_INT enabled. PU/PD class a. Value at internal reset: T/PD. See section 4.2.14 for detailed electrical specs.
27	SCL	DDC	O	I2C bus clock line	Fixed open drain. See section 4.2.13 for detailed electrical specs.
		GDI	O	AUX UART data output ²¹	Circuit 104 (RxD) in ITU-T V.24. Output driver class A. PU/PD class a. Value at internal reset: T/PU. See section 4.2.14 for detailed electrical specs.
28	USB_D-	USB	I/O	USB Data Line D-	90 Ω nominal differential characteristic impedance. Pull-up, pull-down and series resistors as required by the USB 2.0 specifications [15] are part of the USB pin driver, and need not be provided externally. See section 4.2.11 for detailed electrical specs.
29	USB_D+	USB	I/O	USB Data Line D+	90 Ω nominal differential characteristic impedance. Pull-up, pull-down and series resistors as required by the USB 2.0 specifications [15] are part of the USB pin driver, and need not be provided externally. See section 4.2.11 for detailed electrical specs.
30	GND	-	N/A	Ground	All the GND pins must be connected to ground
31	RSVD	-	N/A	RESERVED pin	Leave unconnected.
32	GND	-	N/A	Ground	All the GND pins must be connected to ground
33	RSVD	-	N/A	RESERVED pin	This pin has special function: it must be connected to GND to allow module to work properly.
34	I2S_WA	GDI	I/O / I/O	I2S word alignment / GPIO	Configurable as I2S word alignment, or as GPIO (see 2.8). I2S not supported by LARA-R204-02B, LARA-R220-62B. Output driver class A. PU/PD class a. Value at internal reset: T/PD. See section 4.2.14 for detailed electrical specs.
35	I2S_TXD	GDI	O / I/O	I2S transmit data / GPIO	Configurable as I2S transmit data out, or as GPIO (see 2.8). I2S not supported by LARA-R204-02B, LARA-R220-62B. Output driver class A. PU/PD class a. Value at internal reset: T/PD. See section 4.2.14 for detailed electrical specs.

²¹ The auxiliary UART interface is not supported by the '02B', '62B' and '82B' versions of LARA-R202, LARA-R203, LARA-R204, LARA-R220, LARA-R280, and LARA-R281 modules, and by '02B-00', '02B-01' and '02B-02' versions of LARA-R211 modules.

No	Name	Power domain	I/O	Description	Remarks
36	I2S_CLK	GDI	I/O / I/O	I2S clock / GPIO	Configurable as I2S clock, or as GPIO (see 2.8). I2S not supported by LARA-R204-02B, LARA-R220-62B. Output driver class A. PU/PD class a. Value at internal reset: T/PD. See section 4.2.14 for detailed electrical specs.
37	I2S_RXD	GDI	I / I/O	I2S receive data / GPIO	Configurable as I2S receive data input, or as GPIO (see 2.8). I2S not supported by LARA-R204-02B, LARA-R220-62B. Output driver class A. PU/PD class a. Value at internal reset: T/PD. See section 4.2.14 for detailed electrical specs.
38	SIM_CLK	SIM	O	SIM clock	See section 4.2.9 for detailed electrical specs.
39	SIM_IO	SIM	I/O	SIM data	Internal 4.7 kΩ pull-up resistor to VSIM. See section 4.2.9 for detailed electrical specs.
40	SIM_RST	SIM	O	SIM reset	See section 4.2.9 for detailed electrical specs.
41	VSIM	-	O	SIM supply output	VSIM = 1.80 V typical or 2.90 V typical generated by the module according to the external SIM card/chip type. See section 4.2.2 for detailed electrical specs.
42	GPIO5	GDI	I/O	GPIO	Configurable for SIM card detection, or as GPIO (see 2.8). Output driver class A. PU/PD class a. Value at internal reset: T/PD. See section 4.2.14 for detailed electrical specs.
43	GND	-	N/A	Ground	All the GND pins must be connected to ground
44	SDIO_D2	GDI	I/O	SDIO serial data [2]	SDIO not supported by '02B', '62B', '82B', '03B' versions. Output driver class A. PU/PD class a. Value at internal reset: T/PD. See section 4.2.14 for detailed electrical specs.
45	SDIO_CLK	GDI	O	SDIO serial clock	SDIO not supported by '02B', '62B', '82B', '03B' versions. Output driver class A. PU/PD class a. Value at internal reset: T/PD. See section 4.2.14 for detailed electrical specs.
46	SDIO_CMD	GDI	I/O	SDIO command	SDIO not supported by '02B', '62B', '82B', '03B' versions. Output driver class A. PU/PD class a. Value at internal reset: T/PD. See section 4.2.14 for detailed electrical specs.
47	SDIO_D0	GDI	I/O	SDIO serial data [0]	SDIO not supported by '02B', '62B', '82B', '03B' versions. Output driver class A. PU/PD class a. Value at internal reset: T/PD. See section 4.2.14 for detailed electrical specs.
48	SDIO_D3	GDI	I/O	SDIO serial data [3]	SDIO not supported by '02B', '62B', '82B', '03B' versions. Output driver class A. PU/PD class a. Value at internal reset: T/PD. See section 4.2.14 for detailed electrical specs.
49	SDIO_D1	GDI	I/O	SDIO serial data [1]	SDIO not supported by '02B', '62B', '82B', '03B' versions. Output driver class A. PU/PD class a. Value at internal reset: T/PD. See section 4.2.14 for detailed electrical specs.
50	GND	-	N/A	Ground	All the GND pins must be connected to ground
51	VCC	-	I	Module supply input	Supply for BB part on LARA-R211 modules. Supply for BB part and RF PA on other LARA-R2 modules. All VCC pins must be connected to external supply. See sections 4.2.2 and 4.2.3 for detailed specs.



No	Name	Power domain	I/O	Description	Remarks
52	VCC	-	I	Module supply input	Supply for RF PA on LARA-R211 modules. Supply for BB part and RF PA on other LARA-R2 modules. All VCC pins must be connected to external supply. See sections 4.2.2 and 4.2.3 for detailed specs.
53	VCC	-	I	Module supply input	Supply for RF PA on LARA-R211 modules. Supply for BB part and RF PA on other LARA-R2 modules. All VCC pins must be connected to external supply. See sections 4.2.2 and 4.2.3 for detailed specs.
54	GND	-	N/A	Ground	All the GND pins must be connected to ground
55	GND	-	N/A	Ground	All the GND pins must be connected to ground
56	ANT1	ANT	I/O	Primary antenna	50 Ω nominal characteristic impedance. Main Tx / Rx antenna interface. See section 4.2.4 / 4.2.6 for details.
57	GND	GND	N/A	Ground	All GND pins must be connected to ground.
58	GND	GND	N/A	Ground	All GND pins must be connected to ground.
59	ANT_DET	ADC	I	Antenna detection	Antenna presence detection function. See section 4.2.7 for detailed electrical specs.
60	GND	GND	N/A	Ground	All GND pins must be connected to ground.
61	GND	GND	N/A	Ground	All GND pins must be connected to ground.
62	ANT2	ANT	I	Secondary antenna	50 Ω nominal characteristic impedance. Rx only for Down-Link Rx diversity. See section 4.2.4 for details.
63	GND	-	N/A	Ground	All the GND pins must be connected to ground
64	GND	-	N/A	Ground	All the GND pins must be connected to ground
65-96	GND	-	N/A	Ground	All the GND pins must be connected to ground
97	RSVD	-	N/A	RESERVED pin	Leave unconnected.
98	RSVD	-	N/A	RESERVED pin	Leave unconnected.
99	HSIC_DATA	HSIC	I/O	HSIC USB data line	HSIC not supported by '02B', '62B', '82B', '03B' versions. 50 Ω nominal characteristic impedance. See section 4.2.12 for detailed electrical specs.
100	HSIC_STRB	HSIC	I/O	HSIC USB strobe line	HSIC not supported by '02B', '62B', '82B', '03B' versions. 50 Ω nominal characteristic impedance. See section 4.2.12 for detailed electrical specs.

Table 5: LARA-R2 series pin-out

 For more information about the pin-out, see the LARA-R2 series system integration manual [2].

 See appendix A for an explanation of the abbreviations and terms used.

4 Electrical specifications

-  Stressing the device above one or more of the ratings listed in the Absolute Maximum Rating section may cause permanent damage. These are stress ratings only. Operating the module at these or at any conditions other than those specified in the Operating Conditions sections (section 4.2) of the specification should be avoided. Exposure to Absolute Maximum Rating conditions for extended periods may affect device reliability.
-  Operating condition ranges define limits within which the functionality of the device is guaranteed.
-  Where application information is given, it is advisory only and does not form part of the specification.

4.1 Absolute maximum rating

-  Limit values given below are in accordance with the Absolute Maximum Rating System (IEC 134).

Symbol	Description	Condition	Min.	Max.	Unit
VCC	Module supply voltage	Input DC voltage at VCC pin	-0.30	5.00	V
V_BCKP	RTC supply voltage	Input DC voltage at V_BCKP pin	-0.15	2.00	V
VUSB_DET	USB detection pin	Input DC voltage at VUSB_DET pin	-0.15	5.50	V
USB	USB D+/D- pins	Input DC voltage at USB_D+ and USB_D- pins	-1.00	5.50	V
GDI	Generic digital interfaces	Input DC voltage at Generic digital interfaces pins	-0.30	3.60	V
HSIC	HSIC interface	Input DC voltage at HSIC interface pins	-0.30	3.60	V
DDC	DDC interface	Input DC voltage at DDC interface pins	-0.30	3.60	V
SIM	SIM interface	Input DC voltage at SIM interface pins	-0.30	3.60	V
ERS	External reset signal	Input DC voltage at RESET_N pin	-0.30	2.10	V
POS	Power-on input	Input DC voltage at PWR_ON pin	-0.30	2.10	V
Tstg	Storage Temperature		-40	+85	°C

Table 6: Absolute maximum ratings

-  The product is not protected against overvoltage or reversed voltages. If necessary, voltage spikes exceeding the power supply voltage specification, given in the table above, must be limited to values within the specified boundaries by using appropriate protection devices.

4.1.1 Maximum ESD

Parameter	Module	Min	Max	Unit	Remarks
ESD sensitivity for all pins except ANT1 / ANT2 pins	All		1000	V	Human Body Model according to J ESD22-A114
ESD sensitivity for ANT1 / ANT2 pins	All		1000	V	Human Body Model according to JESD22-A114
ESD immunity for ANT1 pin	All		4000	V	Contact Discharge according to IEC 61000-4-2
			8000	V	Air Discharge according to IEC 61000-4-2
ESD immunity for ANT2 pin	All except LARA-R204		4000	V	Contact Discharge according to IEC 61000-4-2
			8000	V	Air Discharge according to IEC 61000-4-2
	LARA-R204		1000	V	Contact Discharge according to IEC 61000-4-2
			2000	V	Air Discharge according to IEC 61000-4-2

Table 7: Maximum ESD ratings

-  u-blox cellular modules are Electrostatic Sensitive Devices and require special precautions when handling. See section 7.4 for ESD handling instructions.

4.2 Operating conditions

Unless otherwise indicated, all operating condition specifications are at an ambient temperature of +25 °C.

Operation beyond the operating conditions is not recommended and extended exposure beyond them may affect device reliability.

4.2.1 Operating temperature range

Parameter	Min.	Typical	Max.	Unit	Remarks
Normal operating temperature	-20	+25	+65	°C	Normal operating temperature range (fully functional and meet 3GPP / ETSI specifications)
Extended operating temperature	-40		+85	°C	Extended operating temperature range (RF performance may be affected outside normal operating range, though module is fully functional)

Table 8: Environmental conditions

4.2.2 Supply/power pins

Symbol	Parameter	Min.	Typical	Max.	Unit
VCC	Module supply normal operating input voltage ²²	3.30	3.80	4.40	V
	Module supply extended operating input voltage ²³	3.00	3.80	4.50	V
	Module supply extended operating input voltage ²⁴	2.80	3.80	4.50	V
V_BCKP	Real Time Clock supply input voltage	1.00	1.80	1.90	V
I_BCKP	Real Time Clock supply average current consumption, at V_BCKP = 1.8 V		2.00	5	µA

Table 9: Input characteristics of the Supply/Power pins

Symbol	Parameter	Min.	Typical	Max.	Unit
VSIM	SIM supply output voltage, with external 1.8 V SIM		1.80		V
	SIM supply output voltage, with external 3.0 V SIM		2.90		V
V_BCKP	Real Time Clock supply output voltage		1.80		V
I_BCKP	Real Time Clock supply output current capability			3	mA
V_INT	Generic Digital Interfaces supply output voltage		1.80		V
V_INT_RIPPLE	Generic Digital Interfaces supply output voltage ripple with power saving disabled (AT+UPSV=0)			15	mVpp
	Generic Digital Interfaces supply output voltage ripple with power saving enabled (AT+UPSV=1 / 2 / 3)			35	mVpp
I_INT	Generic Digital Interfaces supply output current capability			70	mA

Table 10: Output characteristics of the Supply/Power pins

²² RF performance may be affected when the input voltage at **VCC** is outside the herein stated normal operating range limits, though the module is still fully functional when the input voltage at **VCC** is inside the extended operating range limits.

²³ Range defined for the **VCC** pin #51 (supply input for internal baseband Power Management Unit and transceiver) of LARA-R211 modules, and for all the **VCC** pins of the other LARA-R2 series modules, and. Input voltage at the related **VCC** pins must be above the herein stated extended operating range minimum limit to switch on the LARA-R2 series modules. The LARA-R2 series modules may switch off when the input voltage at the related **VCC** pins drops below the herein stated extended operating range minimum limit.

²⁴ Range defined for the **VCC** pins #52 and #53 (supply input for the internal power amplifier) of LARA-R211 modules.

4.2.3 Current consumption

Mode	Condition	Tx power	Min	Typ ²⁵	Max ²⁶	Unit
Idle-Mode (Power Saving enabled by AT+UPSV, module in low power idle-mode, equivalent to airplane mode)	Averaged value over a 100-ms period, USB not connected			0.9		mA
	Averaged value over a 100-ms period, USB connected and suspended			1.1		mA
Cyclic Idle/Active-Mode (Power Saving enabled by AT+UPSV, Module registered with network)	Averaged value over a 10-minute period, USB not connected			1.4		mA
	Averaged value over a 10-minute period, USB connected and suspended			1.6		mA
Active-Mode (Power Saving disabled by AT+UPSV, Module registered with network)	Averaged value over a 10-minute period, USB not connected			11.1		mA
	Averaged value over a 10-minute period, USB connected and not suspended			29.5		mA
2G Connected Mode (Tx / Rx call enabled)	Pulse value during a 1-slot GMSK Tx burst, 900 MHz band	Maximum		1.9	2.5	A
		Minimum		50		mA
	Averaged value over a 10-second period, 2G GMSK call, 1 Tx + 1 Rx slot, 900 MHz	Maximum		275		mA
		Minimum		50		mA
		Maximum		215		mA
		Minimum		50		mA
3G Connected Mode (Tx / Rx call enabled)	Averaged value over a 10-second period ²⁷	Minimum		115		mA
		0 dBm		125		mA
		12 dBm		170		mA
		18 dBm		265		mA
		Maximum		490		mA
LTE Connected Mode (Tx / Rx call enabled)	Averaged value over a 10-second period ²⁷	Minimum		185		mA
		0 dBm		200		mA
		12 dBm		245		mA
		18 dBm		365		mA
		Maximum		540		mA

Table 11: LARA-R2 series modules VCC current consumption

Parameter	Min	Typ	Max	Unit
Current consumption through the VCC pin #51 of LARA-R211 modules (supply input for internal baseband Power Management Unit and the internal transceiver)			300	mA

Table 12: LARA-R211 modules VCC pin #51 current consumption

²⁵ Typical values with a matched antenna

²⁶ Maximum values with a mismatched antenna

²⁷ 3G/LTE current consumption in Tx connected mode may be slightly higher on the LARA-R202-02B-04, LARA-R202-82B-01, LARA-R203-02B-04, LARA-R203-02B-35, LARA-R211-02B-04 product type numbers

4.2.4 LTE RF characteristics

The LTE bands supported by each LARA-R2 series module are defined in [Table 2](#), while the following [Table 13](#) describes the Transmitting and Receiving frequencies for each LTE band according to 3GPP TS 36.521-1 [11].

Parameter		Min.	Max.	Unit	Remarks
Frequency range Band 12 (700 MHz) ²⁸	Uplink	699	716	MHz	Module transmits
	Downlink	729	746	MHz	Module receives
Frequency range Band 13 (700 MHz)	Uplink	777	787	MHz	Module transmits
	Downlink	746	756	MHz	Module receives
Frequency range Band 28 (700 MHz)	Uplink	703	748	MHz	Module transmits
	Downlink	758	803	MHz	Module receives
Frequency range Band 20 (800 MHz)	Uplink	832	862	MHz	Module transmits
	Downlink	791	821	MHz	Module receives
Frequency range Band 19 (850 MHz)	Uplink	830	845	MHz	Module transmits
	Downlink	875	890	MHz	Module receives
Frequency range Band 5 (850 MHz)	Uplink	824	849	MHz	Module transmits
	Downlink	869	894	MHz	Module receives
Frequency range Band 8 (900 MHz)	Uplink	880	915	MHz	Module transmits
	Downlink	925	960	MHz	Module receives
Frequency range Band 4 (1700 MHz)	Uplink	1710	1755	MHz	Module transmits
	Downlink	2110	2155	MHz	Module receives
Frequency range Band 3 (1800 MHz)	Uplink	1710	1785	MHz	Module transmits
	Downlink	1805	1880	MHz	Module receives
Frequency range Band 2 (1900 MHz)	Uplink	1850	1910	MHz	Module transmits
	Downlink	1930	1990	MHz	Module receives
Frequency range Band 1 (2100 MHz)	Uplink	1920	1980	MHz	Module transmits
	Downlink	2110	2170	MHz	Module receives
Frequency range Band 7 (2600 MHz)	Uplink	2500	2570	MHz	Module transmits
	Downlink	2620	2690	MHz	Module receives

Table 13: LTE operating RF frequency bands

LARA-R2 series modules include a UE Power Class 3 LTE transmitter (see [Table 2](#)), with output power and characteristics according to 3GPP TS 36.521-1 [11].

LARA-R2 series modules LTE receiver characteristics are compliant to 3GPP TS 36.521-1 [11], with LTE conducted receiver sensitivity performance described in [Table 14](#).

Parameter	Min.	Typical	Max.	Unit	Remarks
Receiver input sensitivity Band 12 (700 MHz)	-111.0			dBm	Channel bandwidth = 1.4 MHz
	-108.0			dBm	Channel bandwidth = 3 MHz
	-105.5			dBm	Channel bandwidth = 5 MHz
	-102.5			dBm	Channel bandwidth = 10 MHz
Receiver input sensitivity Band 13 (700 MHz)	-105.0			dBm	Channel bandwidth = 5 MHz
	-102.0			dBm	Channel bandwidth = 10 MHz
Receiver input sensitivity Band 28 (700 MHz)	-107.0			dBm	Channel bandwidth = 3 MHz
	-105.5			dBm	Channel bandwidth = 5 MHz
	-102.5			dBm	Channel bandwidth = 10 MHz

²⁸ LTE band 12 is a superset that includes band 17: LTE band 12 is supported with Multi-Frequency Band Indicator (MFBI) feature

Parameter	Min.	Typical	Max.	Unit	Remarks
Receiver input sensitivity		-100.5		dBm	Channel bandwidth = 15 MHz
		-99.5		dBm	Channel bandwidth = 20 MHz
Receiver input sensitivity Band 20 (800 MHz)		-105.0		dBm	Channel bandwidth = 5 MHz
		-102.0		dBm	Channel bandwidth = 10 MHz
		-100.0		dBm	Channel bandwidth = 15 MHz
		-98.5		dBm	Channel bandwidth = 20 MHz
Receiver input sensitivity Band 19 (850 MHz)		-105.0		dBm	Channel bandwidth = 5 MHz
		-102.5		dBm	Channel bandwidth = 10 MHz
		-100.5		dBm	Channel bandwidth = 15 MHz
Receiver input sensitivity Band 5 (850 MHz)		-110.0		dBm	Channel bandwidth = 1.4 MHz
		-107.5		dBm	Channel bandwidth = 3 MHz
		-105.0		dBm	Channel bandwidth = 5 MHz
		-102.5		dBm	Channel bandwidth = 10 MHz
Receiver input sensitivity Band 8 (900 MHz)		-111.0		dBm	Channel bandwidth = 1.4 MHz
		-108.0		dBm	Channel bandwidth = 3 MHz
		-105.0		dBm	Channel bandwidth = 5 MHz
		-102.5		dBm	Channel bandwidth = 10 MHz
Receiver input sensitivity Band 4 (1700 MHz)		-111.5		dBm	Channel bandwidth = 1.4 MHz
		-108.0		dBm	Channel bandwidth = 3 MHz
		-105.5		dBm	Channel bandwidth = 5 MHz
		-103.0		dBm	Channel bandwidth = 10 MHz
		-101.0		dBm	Channel bandwidth = 15 MHz
		-100.0		dBm	Channel bandwidth = 20 MHz
Receiver input sensitivity Band 3 (1800 MHz)		-111.0		dBm	Channel bandwidth = 1.4 MHz
		-108.0		dBm	Channel bandwidth = 3 MHz
		-105.0		dBm	Channel bandwidth = 5 MHz
		-103.0		dBm	Channel bandwidth = 10 MHz
		-101.0		dBm	Channel bandwidth = 15 MHz
		-100.0		dBm	Channel bandwidth = 20 MHz
Receiver input sensitivity Band 2 (1900 MHz)		-110.0		dBm	Channel bandwidth = 1.4 MHz
		-107.0		dBm	Channel bandwidth = 3 MHz
		-104.5		dBm	Channel bandwidth = 5 MHz
		-102.0		dBm	Channel bandwidth = 10 MHz
		-100.0		dBm	Channel bandwidth = 15 MHz
		-99.0		dBm	Channel bandwidth = 20 MHz
Receiver input sensitivity Band 1 (2100 MHz)		-104.0		dBm	Channel bandwidth = 5 MHz
		-101.0		dBm	Channel bandwidth = 10 MHz
		-99.0		dBm	Channel bandwidth = 15 MHz
		-98.0		dBm	Channel bandwidth = 20 MHz
Receiver input sensitivity Band 7 (2600 MHz)		-104.0		dBm	Channel bandwidth = 5 MHz
		-101.0		dBm	Channel bandwidth = 10 MHz
		-99.5		dBm	Channel bandwidth = 15 MHz
		-98.5		dBm	Channel bandwidth = 20 MHz

Condition: 50 Ω source, throughput > 95%, dual receiver, QPSK modulation, other settings as per 3GPP TS 36.521-1 [11]

Table 14: LTE receiver sensitivity performance

4.2.5 3G RF characteristics

The 3G bands supported by LARA-R2 series modules are defined in [Table 2](#), while [Table 15](#) describes the Transmitting and Receiving frequencies for each 3G band according to 3GPP TS 34.121-1 [12].

Parameter		Min.	Max.	Unit	Remarks
Frequency range Band 5 (850 MHz)	Uplink	824	849	MHz	Module transmits
	Downlink	869	894	MHz	Module receives
Frequency range Band 2 (1900 MHz)	Uplink	1850	1910	MHz	Module transmits
	Downlink	1930	1990	MHz	Module receives
Frequency range Band 1 (2100 MHz)	Uplink	1920	1980	MHz	Module transmits
	Downlink	2110	2170	MHz	Module receives

Table 15: 3G operating RF frequency bands

LARA-R2 series modules include a UE Power Class 3 3G transmitter (see [Table 2](#)), with output power and characteristics according to 3GPP TS 34.121-1 [12].

LARA-R2 series modules 3G receiver characteristics are compliant to 3GPP TS 34.121-1 [12], with 3G conducted receiver sensitivity performance described in [Table 16](#).

Parameter	Min.	Typical	Max.	Unit	Remarks
Receiver input sensitivity Band 5 (850 MHz)	-115.0			dBm	Downlink RF level for RMC @ BER < 0.1%
Receiver input sensitivity Band 2 (1900 MHz)	-114.0			dBm	Downlink RF level for RMC @ BER < 0.1%
Receiver input sensitivity Band 1 (2100 MHz)	-114.0			dBm	Downlink RF level for RMC @ BER < 0.1%

Condition: 50 Ω source, dual receiver, other settings as per 3GPP TS 34.121-1 [12]

Table 16: 3G receiver sensitivity performance

4.2.6 2G RF characteristics

The 2G bands supported by LARA-R2 series modules are defined in [Table 2](#), while [Table 17](#) describes the Transmitting and Receiving frequencies for each 2G band according to 3GPP TS 51.010-1 [13].

Parameter		Min.	Max.	Unit	Remarks
Frequency range E-GSM 900	Uplink	880	915	MHz	Module transmits
	Downlink	925	960	MHz	Module receives
Frequency range DCS 1800	Uplink	1710	1785	MHz	Module transmits
	Downlink	1805	1880	MHz	Module receives

Table 17: 2G operating RF frequency bands

LARA-R2 series modules include a GMSK Power Class 4 transmitter for E-GSM 900 band, GMSK Power Class 1 transmitter for the DCS 1800 band, 8-PSK Power Class E2 transmitter for all 2G bands (see [Table 2](#)), with output power and characteristics according to 3GPP TS 51.010-1 [13].

LARA-R2 series modules 2G receiver characteristics are compliant to 3GPP TS 51.010-1 [13], with conducted receiver sensitivity performance described in [Table 18](#).

Parameter	Min.	Typical	Max.	Unit	Remarks
Receiver input sensitivity E-GSM 900	-110.0			dBm	Downlink RF level @ BER Class II < 2.4%
Receiver input sensitivity DCS 1800	-109.0			dBm	Downlink RF level @ BER Class II < 2.4%

Condition: 50 Ω source, other settings as per 3GPP TS 51.010-1 [13]

Table 18: 2G receiver sensitivity performance

4.2.7 ANT_DET pin

Pin Name	Parameter	Min.	Typical	Max.	Unit	Remarks
ANT_DET	Output DC current pulse value		9		μA	Triggered by the +UANTR AT command
	Output DC current pulse time length		330		μs	Triggered by the +UANTR AT command

Table 19: ANT_DET pin characteristics

4.2.8 PWR_ON pin

Pin Name	Parameter	Min.	Typical	Max.	Unit	Remarks
PWR_ON	Internal supply for Power-On Input Signal		1.80		V	RTC supply (V_BCKP)
	Low-level input	-0.30		0.54	V	
	High-level input	1.26		2.10	V	
	Pull-up resistance		10		kΩ	Internal active pull-up to V_BCKP
	Low-level input current		-180		μA	
	Low pulse time	50			μs	Low pulse time to switch on the module
	Low pulse time	1			s	Low pulse time to switch off the module

Table 20: PWR_ON pin characteristics

4.2.9 RESET_N pin

Pin Name	Parameter	Min.	Typical	Max.	Unit	Remarks
RESET_N	Internal supply for External Reset Input Signal		1.80		V	RTC supply (V_BCKP)
	Low-level input	-0.30		0.54	V	
	High-level input	1.26		2.10	V	
	Pull-up resistance		10		kΩ	Internal active pull-up to V_BCKP
	Low-level input current		-180		μA	
	Low pulse time	50			ms	Low pulse time to reset the module

Table 21: RESET_N pin characteristics

4.2.10 SIM pins

The SIM pins are a dedicated interface to the external SIM card/chip. The electrical characteristics fulfill the regulatory specification requirements. The values in [Table 22](#) are for information only.

Parameter	Min.	Typical	Max.	Unit	Remarks
Low-level input	0.00		0.35	V	VSIM = 1.80 V
	0.00		0.57	V	VSIM = 2.90 V
High-level input	1.29		3.30	V	VSIM = 1.80 V
	2.07		3.30	V	VSIM = 2.90 V
Low-level output		0.00	0.35	V	VSIM = 1.80 V, Max value at I _{OL} = +1.0 mA
		0.00	0.35	V	VSIM = 2.90 V, Max value at I _{OL} = +1.0 mA
High-level output	1.26	1.80		V	VSIM = 1.80 V, Min value at I _{OH} = -1.0 mA
	2.03	2.90		V	VSIM = 2.90 V, Min value at I _{OH} = -1.0 mA
Input/Output leakage current			0.7	μA	0.2V < V _{IN} < 3.3V
Clock frequency on SIM_CLK		3.25		MHz	
Internal pull-up resistor on SIM_IO		4.7		kΩ	Internal pull-up to VSIM supply

Table 22: SIM pins characteristics

4.2.11 USB pins

USB data lines (**USB_D+** / **USB_D-**) are compliant with the USB 2.0 high-speed specification. See the Universal Serial Bus specification revision 2.0 [15] for detailed electrical characteristics. The values in [Table 23](#) related to USB 2.0 high-speed physical layer specifications are for information only.

Parameter	Min.	Typical	Max.	Unit	Remarks
VUSB_DET pin, High-level input	1.50	5.00	5.25	V	
VUSB_DET pin, Low-level input	-0.15	0.00	0.40	V	
VUSB_DET pin, input current sink		25		μA	
High-speed squelch detection threshold (input differential signal amplitude)	100		150	mV	
High speed disconnect detection threshold (input differential signal amplitude)	525		625	mV	
High-speed data signaling input common mode voltage range	-50		500	mV	
High-speed idle output level	-10		10	mV	
High-speed data signaling output high level	360		440	mV	
High-speed data signaling output low level	-10		10	mV	
Chirp J level (output differential voltage)	700		1100	mV	
Chirp K level (output differential voltage)	-900		-500	mV	

Table 23: USB pins characteristics

4.2.12 HSIC pins

The HSIC USB lines (**HSIC_DATA** / **HSIC_STRB**) are compliant with the High-Speed Inter-Chip USB specification. See the High-Speed Inter-Chip USB Electrical Specification version 1.0 [16] and the USB specification revision 2.0 [15] for detailed electrical characteristics. The values in [Table 24](#) related to the High-Speed Inter-Chip USB electrical specifications are for information only.

Parameter	Min	Typical	Max	Unit	Remarks
Internal supply for HSIC domain		1.20		V	
Low-level input	-0.30		0.42	V	
High-level input	0.78		1.50	V	
Low-level output		0.00	0.30	V	Max value at I _{OL} = +2.0 mA
High-level output	0.90	1.20		V	Min value at I _{OH} = -2.0 mA
Input/output leakage current			0.7	μA	0.2V < V _{IN} < 1.5V

Table 24: HSIC pins characteristics

4.2.13 DDC (I2C) pins

DDC (I2C) lines (**SCL** and **SDA**) are compliant with the I2C-bus standard mode specification. See the I2C-bus specification [17] for detailed electrical characteristics. The values in [Table 25](#) related to I2C-bus standard mode specifications are for information only.

Parameter	Min	Typical	Max	Unit	Remarks
Internal supply for GDI domain		1.80		V	Digital I/O Interfaces supply (V_INT)
Low-level input	-0.20		0.36	V	
High-level input	1.26		2.00	V	
Low-level output		0.00	0.35	V	Max value at I _{OL} = +1.0 mA
Clock frequency on SCL		100		kHz	

Table 25: DDC (I2C) pins characteristics

4.2.14 Generic Digital Interfaces pins

Parameter	Min	Typical	Max	Unit	Remarks
Internal supply for GDI domain		1.80		V	Digital I/O Interfaces supply (V_INT)
Low-level input	-0.20		0.36	V	
High-level input	1.26		2.00	V	
Low-level output		0.00	0.35	V	Max value at I _{OL} = +6.0 mA for driver class A
High-level output	1.45	1.80		V	Min value at I _{OH} = -6.0 mA for driver class A
Internal pull-up input current			-240	μA	PU class a
			-110	μA	PU class b
Internal pull-down input current			240	μA	PD class a
			100	μA	PD class b
Input/output leakage current			0.7	μA	0.2V < V _{IN} < 2.0V

Table 26: GDI pins characteristics

4.2.14.1 AC characteristics of clock output pin

Parameter	Description	Min	Typical	Max	Unit	Remarks
1/T1	GPIO6 clock output frequency		13		MHz	AT+UMCLK=2
			26		MHz	AT+UMCLK=3

Table 27: AC characteristics of GPIO6 clock output pin

4.2.14.2 AC characteristics of I2S pins

Parameter	Description	Min	Typical	Max	Unit	Remarks
1/T1	I2S_WA frequency		8.000		kHz	<I2S_sample_rate>=0
			11.025		kHz	<I2S_sample_rate>=1
			12.000		kHz	<I2S_sample_rate>=2
			16.000		kHz	<I2S_sample_rate>=3
			22.050		kHz	<I2S_sample_rate>=4
			24.000		kHz	<I2S_sample_rate>=5
			32.000		kHz	<I2S_sample_rate>=6
			44.100		kHz	<I2S_sample_rate>=7
	48.000		kHz	<I2S_sample_rate>=8		
1/T2	I2S_CLK frequency		32		1/T1	<I2S_mode> = 2,...,13
T3	I2S_TXD invalid before I2S_CLK edge			24	ns	<I2S_mode> = 2,...,13
T4	I2S_TXD valid after I2S_CLK edge			32	ns	<I2S_mode> = 2,...,13
T5	I2S_RXD setup time before I2S_CLK edge	60			ns	<I2S_mode> = 2,...,13
T6	I2S_RXD hold time after I2S_CLK edge	10			ns	<I2S_mode> = 2,...,13

Table 28: AC characteristics of digital audio interface (I2S) pins in Normal I2S mode (long synchronization signal), host role

Parameter	Description	Min	Typical	Max	Unit	Remarks
1/T1	I2S_WA frequency			8.000	kHz	<I2S_sample_rate>=0
				11.025	kHz	<I2S_sample_rate>=1
				12.000	kHz	<I2S_sample_rate>=2
				16.000	kHz	<I2S_sample_rate>=3
				22.050	kHz	<I2S_sample_rate>=4
				24.000	kHz	<I2S_sample_rate>=5
				32.000	kHz	<I2S_sample_rate>=6
				44.100	kHz	<I2S_sample_rate>=7
		48.000	kHz	<I2S_sample_rate>=8		

Parameter	Description	Min	Typical	Max	Unit	Remarks
1/T2	I2S_CLK frequency			32	1/T1	<I2S_mode> = 2,...,13
T3	I2S_TXD invalid before I2S_CLK edge			12	ns	<I2S_mode> = 2,...,13
T4	I2S_TXD valid after I2S_CLK edge			79	ns	<I2S_mode> = 2,...,13
T5	I2S_RXD setup time before I2S_CLK edge	22			ns	<I2S_mode> = 2,...,13
T6	I2S_RXD hold time after I2S_CLK edge	24			ns	<I2S_mode> = 2,...,13

Table 29: AC characteristics of digital audio interface (I2S) pins in Normal I2S mode (long synchronization signal), device role

Parameter	Description	Min	Typical	Max	Unit	Remarks
1/T1	I2S_WA frequency		8.000		kHz	<I2S_sample_rate>=0
			11.025		kHz	<I2S_sample_rate>=1
			12.000		kHz	<I2S_sample_rate>=2
			16.000		kHz	<I2S_sample_rate>=3
			22.050		kHz	<I2S_sample_rate>=4
			24.000		kHz	<I2S_sample_rate>=5
			32.000		kHz	<I2S_sample_rate>=6
			44.100		kHz	<I2S_sample_rate>=7
	48.000		kHz	<I2S_sample_rate>=8		
1/T2	I2S_CLK frequency		18		1/T1	<I2S_mode> = 0
			17		1/T1	<I2S_mode> = 1
T3	I2S_WA high begin after I2S_CLK high begin	-24		32	ns	<I2S_mode> = 0, 1
T4	I2S_WA high end after I2S_CLK low end	-24		32	ns	<I2S_mode> = 0, 1
T5	I2S_TXD invalid before I2S_CLK low end			24	ns	<I2S_mode> = 0, 1
T6	I2S_TXD valid after I2S_CLK high begin			22	ns	<I2S_mode> = 0, 1
T7	I2S_RXD setup time before I2S_CLK high end	60			ns	<I2S_mode> = 0, 1
T8	I2S_RXD hold time after I2S_CLK low begin	12			ns	<I2S_mode> = 0, 1

Table 30: AC characteristics of digital audio interface (I2S) pins in PCM mode (short synchronization signal), host role

Parameter	Description	Min	Typical	Max	Unit	Remarks
1/T1	I2S_WA frequency			8.000	kHz	<I2S_sample_rate>=0
				11.025	kHz	<I2S_sample_rate>=1
				12.000	kHz	<I2S_sample_rate>=2
				16.000	kHz	<I2S_sample_rate>=3
				22.050	kHz	<I2S_sample_rate>=4
				24.000	kHz	<I2S_sample_rate>=5
				32.000	kHz	<I2S_sample_rate>=6
				44.100	kHz	<I2S_sample_rate>=7
		48.000	kHz	<I2S_sample_rate>=8		
1/T2	I2S_CLK frequency			18	1/T1	<I2S_mode> = 0
				17	1/T1	<I2S_mode> = 1
T3	I2S_WA high begin before I2S_CLK low begin	36			ns	<I2S_mode> = 0, 1
T4	I2S_WA low begin before I2S_CLK low begin	36			ns	<I2S_mode> = 0, 1
T5	I2S_TXD invalid before I2S_CLK rising edge			12	ns	<I2S_mode> = 0, 1
T6	I2S_TXD valid after I2S_CLK rising edge			79	ns	<I2S_mode> = 0, 1
T7	I2S_RXD setup time before I2S_CLK falling edge	22			ns	<I2S_mode> = 0, 1
T8	I2S_RXD hold time after I2S_CLK falling edge	24			ns	<I2S_mode> = 0, 1

Table 31: AC characteristics of digital audio interface (I2S) pins in PCM mode (short synchronization signal), device role

4.3 Parameters for ATEX applications

This section provides useful parameters and information to integrate LARA-R2 series modules in applications intended for use in areas with potentially explosive atmospheres (ATEX), describing:

- Total internal capacitance and inductance of LARA-R2 series modules (see [Table 32](#))
- Maximum RF output power at the antenna pin of LARA-R2 series modules (see [Table 33](#))

Any specific applicable requirement for the implementation of the apparatus integrating LARA-R2 series modules, intended for use in potentially explosive atmospheres, must be fulfilled according to the exact applicable standards: check the detailed requisites on the pertinent normative for the application, as for example IEC 60079-0 [\[18\]](#), IEC 60079-11 [\[19\]](#), and IEC 60079-26 [\[20\]](#) standards.

The certification of the application device that integrates a LARA-R2 series module and the compliance of the application device with all the applicable certification schemes, directives and standards required for use in potentially explosive atmospheres are the sole responsibility of the application device manufacturer.

[Table 32](#) describes the maximum total internal capacitance and the maximum total internal inductance, considering internal parts tolerance, provided by LARA-R2 series modules.

Module	Parameter	Description	Value	Unit
LARA-R202	Ci	Maximum total internal capacitance	211	μF
	Li	Maximum total internal inductance	26.2	μH
LARA-R203	Ci	Maximum total internal capacitance	211	μF
	Li	Maximum total internal inductance	23.2	μH
LARA-R204	Ci	Maximum total internal capacitance	222	μF
	Li	Maximum total internal inductance	26.0	μH
LARA-R211	Ci	Maximum total internal capacitance	214	μF
	Li	Maximum total internal inductance	26.1	μH
LARA-R220	Ci	Maximum total internal capacitance	213.3	μF
	Li	Maximum total internal inductance	26.0	μH
LARA-R280	Ci	Maximum total internal capacitance	213.3	μF
	Li	Maximum total internal inductance	26.2	μH

Table 32: LARA-R2 series maximum total internal capacitance and maximum total internal inductance

[Table 33](#) describes the maximum RF output power transmitted by LARA-R2 series modules from the primary antenna (**ANT1**) pin as Power Class 4 Mobile Stations for GSM 850 / E-GSM 900 bands and/or as Power Class 3 User Equipment for the LTE and UMTS bands.

Module	Parameter	Description	Value	Unit
LARA-R202	ANT1 Pout	Maximum RF output power from ANT1 pin	25.0	dBm
LARA-R203	ANT1 Pout	Maximum RF output power from ANT1 pin	25.0	dBm
LARA-R204	ANT1 Pout	Maximum RF output power from ANT1 pin	25.0	dBm
LARA-R211	ANT1 Pout	Maximum RF output power from ANT1 pin	35.0	dBm
LARA-R220	ANT1 Pout	Maximum RF output power from ANT1 pin	25.0	dBm
LARA-R280	ANT1 Pout	Maximum RF output power from ANT1 pin	25.0	dBm

Table 33: LARA-R2 series antenna pin (ANT1) maximum RF output power

5 Mechanical specifications

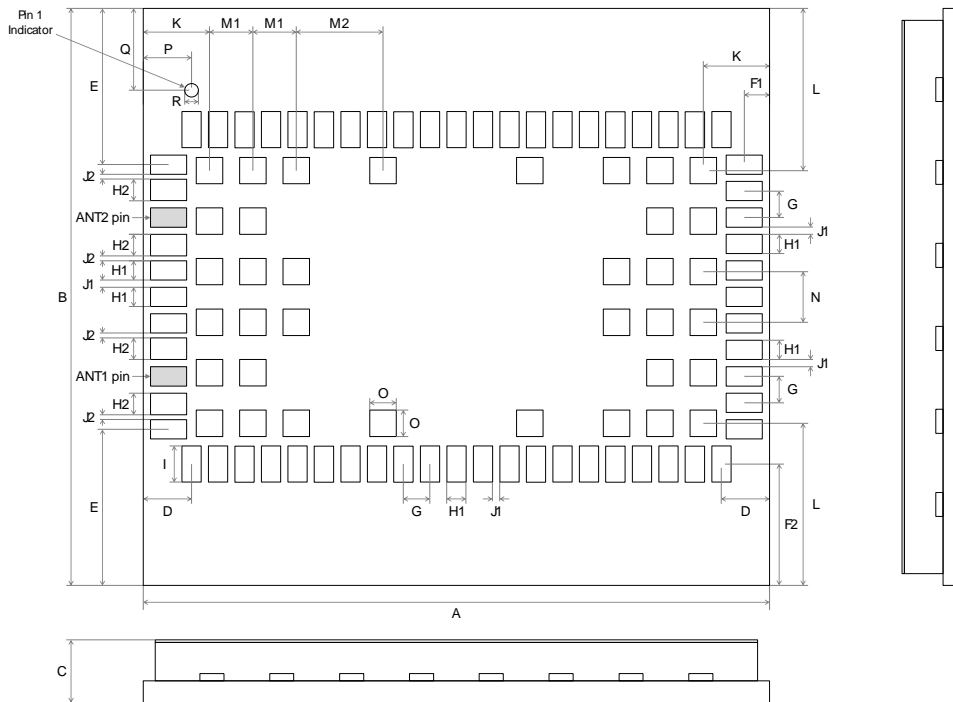

Figure 3: LARA-R2 series dimensions (bottom and side views)

Parameter	Description	Typical	Tolerance
A	Module height [mm]	26.0 (1023.6 mil)	+0.20/-0.20 (+7.9/-7.9 mil)
B	Module width [mm]	24.0 (944.9 mil)	+0.20/-0.20 (+7.9/-7.9 mil)
C	Module thickness [mm]	2.6 (102.4 mil)	+0.27/-0.17 (+10.6/-6.7 mil)
D	Horizontal edge to lateral pin pitch [mm]	2.0 (78.7 mil)	+0.20/-0.20 (+7.9/-7.9 mil)
E	Vertical edge to lateral pin pitch [mm]	6.5 (255.9 mil)	+0.20/-0.20 (+7.9/-7.9 mil)
F1	Edge to lateral pin pitch [mm]	1.05 (41.3 mil)	+0.20/-0.20 (+7.9/-7.9 mil)
F2	Edge to lateral pin pitch [mm]	5.05 (198.8 mil)	+0.20/-0.20 (+7.9/-7.9 mil)
G	Lateral pin to pin pitch [mm]	1.1 (43.3 mil)	+0.05/-0.05 (+2.0/-2.0 mil)
H1	Lateral pin height [mm]	0.8 (31.5 mil)	+0.05/-0.05 (+2.0/-2.0 mil)
H2	Lateral pin close to ANT height [mm]	0.9 (35.4 mil)	+0.05/-0.05 (+2.0/-2.0 mil)
I	Lateral pin width [mm]	1.5 (59.1 mil)	+0.05/-0.05 (+2.0/-2.0 mil)
J1	Lateral pin to pin distance [mm]	0.3 (11.8 mil)	+0.05/-0.05 (+2.0/-2.0 mil)
J2	Lateral pin to pin close to ANT distance [mm]	0.2 (7.9 mil)	+0.05/-0.05 (+2.0/-2.0 mil)
K	Horizontal edge to central pin pitch [mm]	2.75 (108.3 mil)	+0.20/-0.20 (+7.9/-7.9 mil)
L	Vertical edge to central pin pitch [mm]	6.75 (265.7 mil)	+0.20/-0.20 (+7.9/-7.9 mil)
M1	Central pin to pin horizontal pitch [mm]	1.8 (70.9 mil)	+0.05/-0.05 (+2.0/-2.0 mil)
M2	Central pin to pin horizontal pitch [mm]	3.6 (141.7 mil)	+0.05/-0.05 (+2.0/-2.0 mil)
N	Central pin to pin vertical pitch [mm]	2.1 (82.7 mil)	+0.05/-0.05 (+2.0/-2.0 mil)
O	Central pin height and width [mm]	1.1 (43.3 mil)	+0.05/-0.05 (+2.0/-2.0 mil)
P	Horizontal edge to pin 1 indicator pitch [mm]	2.0 (78.7 mil)	+0.20/-0.20 (+7.9/-7.9 mil)
Q	Vertical edge to pin 1 indicator pitch [mm]	3.4 (133.6 mil)	+0.20/-0.20 (+7.9/-7.9 mil)
R	Pin 1 indicator diameter [mm]	0.56 (22.0 mil)	+0.05/-0.05 (+2.0/-2.0 mil)
Weight	Module weight [g]	4	

Table 34: LARA-R2 series dimensions

- Module height tolerance ± 0.20 mm may be exceeded close to the corners of the PCB due to the cutting process. In the worst case, the height could be $+0.40$ mm more than the typical value.
- For information regarding Footprint and Paste Mask recommended for the application board integrating the cellular module, see the LARA-R2 series system integration manual [2].

6 Qualification and approvals

6.1 Reliability tests

Tests for product family qualifications according to ISO 16750 “Road vehicles – Environmental conditions and testing for electrical and electronic equipment”, and appropriate standards.

6.2 Approvals

LARA-R2 series modules comply with the Directive 2011/65/EU of the European Parliament and the Council on the Restriction of Use of certain Hazardous Substances in Electrical and Electronic Equipment (EU RoHS 2) and its amendment Directive (EU) 2015/863 (EU RoHS 3).

LARA-R2 series modules are RoHS 3 compliant.

No natural rubbers, hygroscopic materials, or materials containing asbestos are employed.

[Table 35](#) summarizes the main approvals that have been achieved for LARA-R2 series modules.

Certification scheme	LARA-R202	LARA-R203	LARA-R204	LARA-R211	LARA-R220	LARA-R280	LARA-R281
CE (Europe)				■			■
FCC (United States)	■	■	□				
FCC identification number	XPY1EIQ24NN	XPY1DIQN3NN	XPY1EIQN2NN				
ISED (Canada) ²⁹	■	■	□				
IC certification number	8595A-1EIQ24NN	8595A-1DIQN3NN	8595A-1EIQN2NN				
GITEKI (Japan)					□		
RCM (Australia)						■	
NCC (Taiwan)						■	
PTCRB conformance	■	■					
GCF conformance			□	■			
AT&T	■	■					
T-Mobile US	□	□					
Verizon			□				
U.S. Cellular	□	□					
Rogers	□	□					
Telus	□	□					
Vodafone				■			
Deutsche Telekom				■			
NTT DoCoMo						□	
Note:	■ = certified as voice and data			□ = certified as data only			

Table 35: LARA-R2 series main certification approvals summary

The above listed certifications might not be available for all the different product type numbers. Please contact the u-blox office or sales representative nearest you for the complete list of certification approvals available for the selected product ordering number.

²⁹ Formerly known as IC (Industry Canada)

7 Product handling & soldering

7.1 Packaging

LARA-R2 series modules are delivered as hermetically sealed reeled tapes, to enable efficient production, production lot set-up and tear-down.

For more information about packaging, see the u-blox package information user guide [6].

7.1.1 Reels

LARA-R2 series modules are deliverable in quantities of 150 pieces on a reel. The modules are delivered using reel type B2 described in Figure 4 and in the u-blox package information user guide [6].

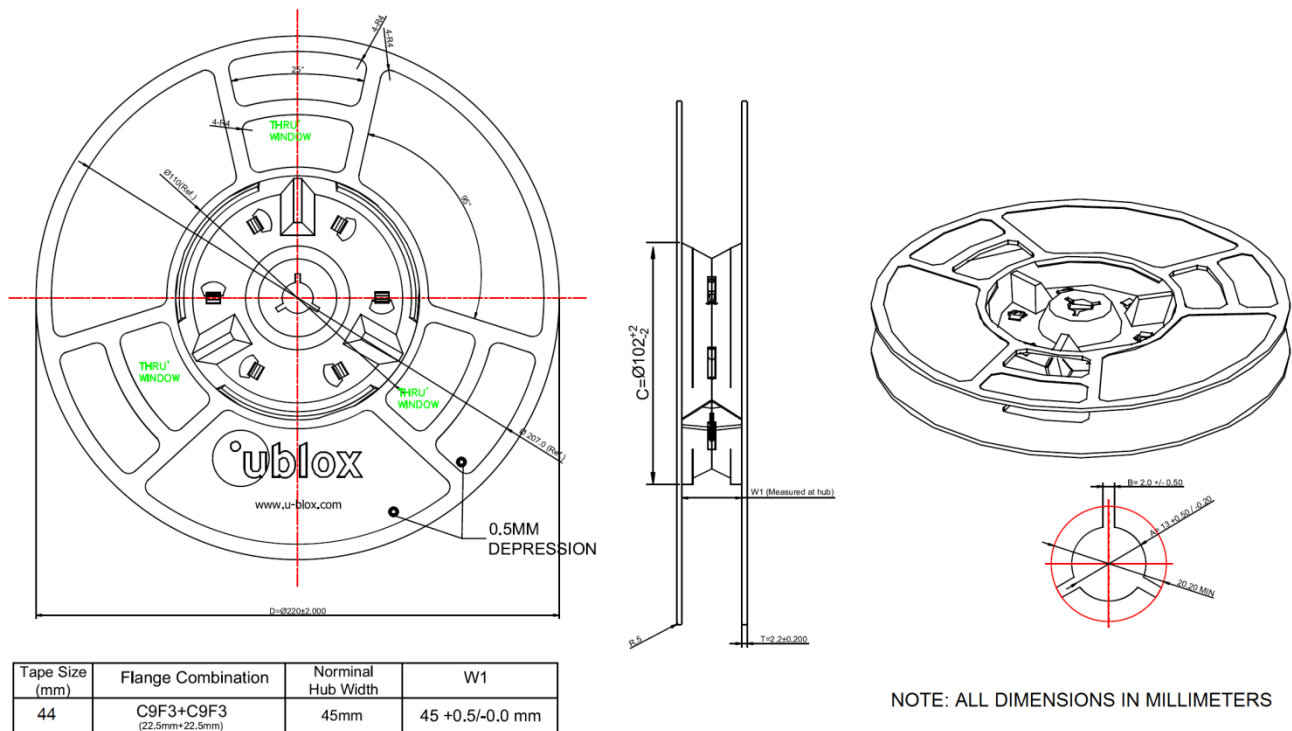

Figure 4: LARA-R2 series modules reel

Parameter	Specification
Reel type	B2
Delivery quantity	150

Table 36: Reel information for LARA-R2 series modules

Quantities of less than 150 pieces are also available. Contact u-blox for more information.

7.1.2 Tapes

Figure 5 shows the position and the orientation of LARA-R2 modules as they are delivered on the tape, while Figure 6 and Table 37 specify the tape dimensions.

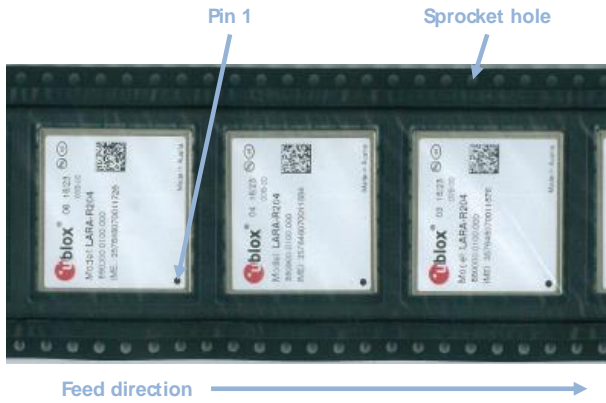

Figure 5: Orientation for LARA-R2 series modules on tape

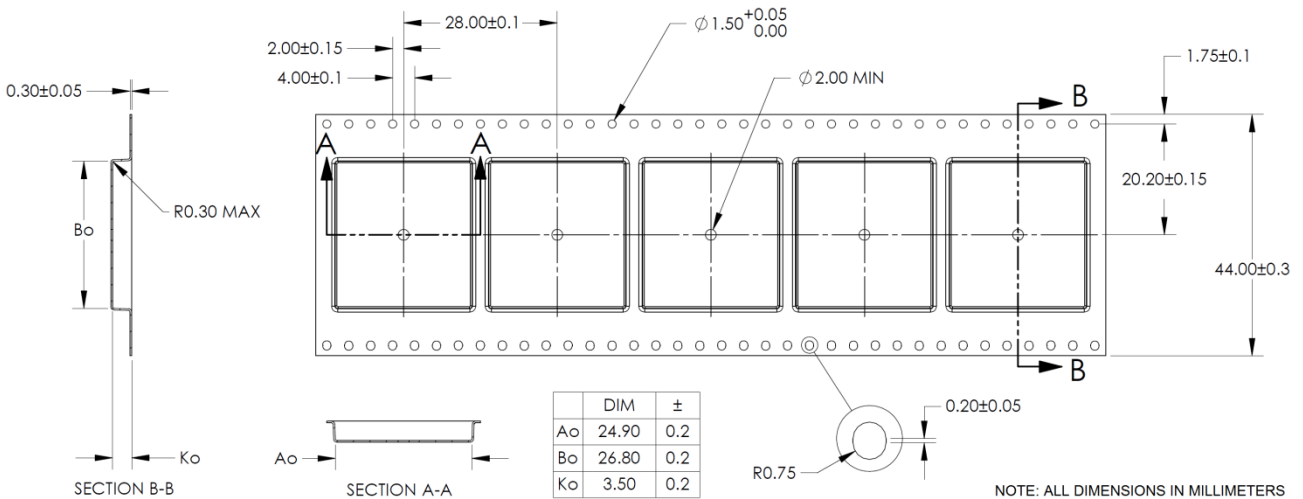



Figure 6: LARA-R2 series modules tape dimensions

Parameter	Typical value	Tolerance	Unit
A ₀	24.9	0.2	mm
B ₀	26.8	0.2	mm
K ₀	3.5	0.2	mm

Table 37: LARA-R2 series modules tape dimensions

- 10 sprocket hole pitch cumulative tolerance ± 0.2 mm.
- Pocket position relative to sprocket hole measured as true position of pocket, not pocket hole.
- A₀ and B₀ are measured on a plane at a distance “R” above the bottom of the pocket.

7.2 Moisture sensitivity levels

-  LARA-R2 series modules are Moisture Sensitive Devices (MSD) in accordance to the IPC/JEDEC specification.

The Moisture Sensitivity Level (MSL) relates to the packaging and handling precautions required. LARA-R2 series modules are rated at MSL level 4. For more information regarding moisture sensitivity levels, labeling, storage and drying see the u-blox package information user guide [6].

-  For the MSL standard, see IPC/JEDEC J-STD-020 (can be downloaded from www.jedec.org).

7.3 Reflow soldering

Reflow profiles are to be selected according to u-blox recommendations (see LARA-R2 series system integration manual [2]).

-  Failure to observe these recommendations can result in severe damage to the device!

7.4 ESD precautions

-  LARA-R2 series modules contain highly sensitive electronic circuitry and are Electrostatic Sensitive Devices (ESD). Handling LARA-R2 series modules without proper ESD protection may destroy or damage them permanently.

LARA-R2 series modules are Electrostatic Sensitive Devices (ESD) and require special ESD precautions typically applied to ESD sensitive components.

[Table 7](#) details the maximum ESD ratings of the LARA-R2 series modules.

Proper ESD handling and packaging procedures must be applied throughout the processing, handling and operation of any application that incorporates the LARA-R2 series module.

ESD precautions should be implemented on the application board where the module is mounted, as described in the LARA-R2 series system integration manual [2].

-  Failure to observe these recommendations can result in severe damage to the device!

8 Default settings

Interface	AT settings	Comments
UART interface	AT interface enabled	AT command mode is enabled by default on the UART physical interface
	AT+IPR=0	One-shot automatic baud rate detection enabled
	AT+ICF=3,1	Frame format: 8 bits, no parity, 1 stop bit  Since AT+IPR=0 is the default value (one-shot automatic baud rate detection enabled), the AT+ICF value in the profile is not applied (AT+IPR=0 overrules the AT+ICF setting) and the one-shot automatic frame detection is active.
	AT&K3	HW flow control enabled
	AT&S1	DSR line set ON in data mode and set OFF in command mode
	AT&D1	Upon an ON-to-OFF transition of DTR, the module enters online command state and issues an OK result code
	AT&C1	Circuit 109 changes in accordance with the Carrier detect status; ON if the Carrier is detected, OFF otherwise
	MUX disabled	Multiplexing mode can be enabled by AT+CMUX command providing following channels: <ul style="list-style-type: none"> • Channel 0: Multiplexer control • Channel 1 – 5: AT commands / data connection • Channel 6: GNSS data tunneling ³⁰
USB interface	Enabled	6 USB CDCs (Communications Device Class) by default available: <ul style="list-style-type: none"> • USB1: AT and data • USB2: AT and data • USB3: AT and data • USB4: GNSS tunneling ³⁰ • USB5: SAP (SIM Access Profile) ³¹ • USB6: Primary Log (diagnostic purpose)
	AT&K3	HW flow control enabled
	AT&S1	DSR line set ON in data mode and set OFF in command mode
	AT&D1	Upon an ON-to-OFF transition of DTR, the module enters online command state and issues an OK result code
	AT&C1	Circuit 109 changes in accordance with the Carrier detect status; ON if the Carrier is detected, OFF otherwise
Power saving	AT+UPSV=0	Disabled
Network registration	AT+COPS=0	Self network registration

Table 38: LARA-R2 series default settings

See the u-blox AT commands manual [\[1\]](#) and the LARA-R2 series system integration manual [\[2\]](#) for information about further settings and factory-programmed values.

³⁰ Not supported by LARA-R204-02B and LARA-R211-02B-00 product versions.

³¹ Not supported by "02B", "62B", "82B", and "03B" product versions.

9 Labeling and ordering information

9.1 Product labeling

The labels of LARA-R2 series modules include important product information as described in this section.

Figure 7, Figure 8 and Figure 9 illustrate the labels of LARA-R2 series modules, which include: u-blox logo, production lot, Pb-free marking, product type number, IMEI number, applicable regulatory certifications' info, and production country.

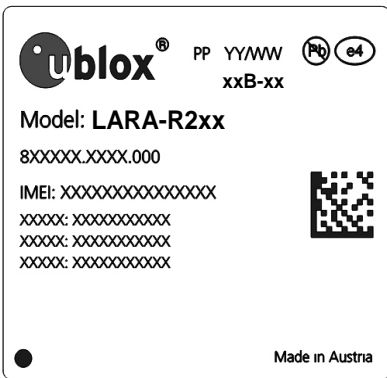

Figure 7: Label of LARA-R202, LARA-R203, LARA-R204, LARA-R280 modules

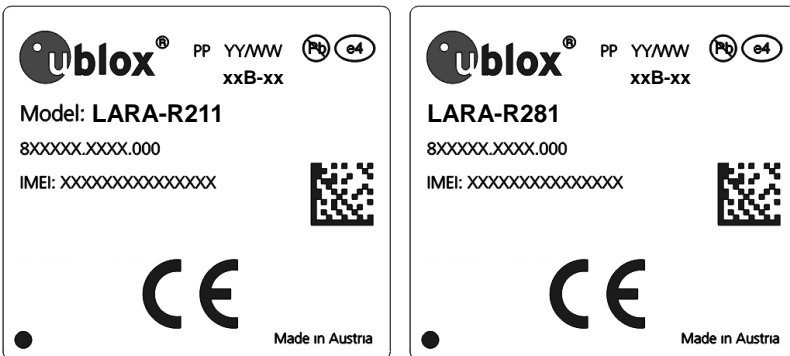

Figure 8: Label of LARA-R211 and LARA-R281 modules

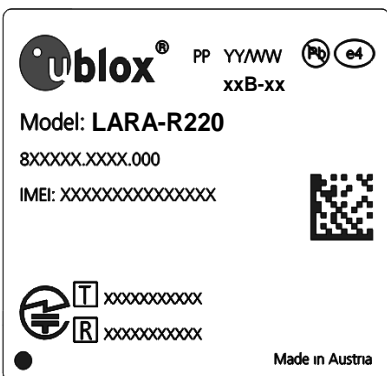

Figure 9: Label of LARA-R220 modules

9.2 Explanation of codes

Three different product code formats are used. The Product Name is used in documentation such as this data sheet and identifies all the u-blox products, independent of packaging and quality grade. The Ordering Code includes options and quality, while the Type Number includes the hardware and firmware versions. [Table 39](#) details these 3 different formats:

Format	Structure
Product Name	PPPP-TGVV
Ordering Code	PPPP-TGVV-MMQ
Type Number	PPPP-TGVV-MMQ-XX

Table 39: Product code formats

[Table 40](#) explains the parts of the product code.

Code	Meaning	Example
PPPP	Form factor	LARA
TG	Platform (Technology and Generation) <ul style="list-style-type: none"> • Dominant technology: G: GSM; U: HSUPA; C: CDMA 1xRTT; N: NB-IoT; R: LTE low data rate (Cat 1 and below); L: LTE high data rate (Cat.3 and above) • Generation: 1...9 	R2
VV	Variant function set based on the same platform [00...99]	04
MM	Major product version [00...99]	02
Q	Product grade <ul style="list-style-type: none"> • B = professional • A = automotive 	B
XX	Minor product version	Default value is 00

Table 40: Part identification code

9.3 Ordering information

Ordering number	Product
LARA-R202-02B	Module supporting LTE Cat 1 bands 2 / 4 / 5 / 12, HSPA bands 2 / 5. Mainly designed for operation in America, with AT&T and T-Mobile MNO approvals beside others. 26.0 x 24.0 x 2.6 mm, 150 pcs/reel
LARA-R202-03B	Module supporting LTE Cat 1 bands 2 / 4 / 5 / 12, HSPA bands 2 / 5. Mainly designed for operation in America, with AT&T, USCC and T-Mobile MNO approvals beside others. 26.0 x 24.0 x 2.6 mm, 150 pcs/reel
LARA-R202-82B	Module supporting LTE Cat 1 bands 2 / 4 / 5 / 12, HSPA bands 2 / 5. Mainly designed for operation in America, with AT&T, USCC and T-Mobile MNO approvals beside others. 26.0 x 24.0 x 2.6 mm, 150 pcs/reel
LARA-R203-02B	Module supporting LTE Cat 1 bands 2 / 4 / 12. Mainly designed for operation in America, with AT&T and T-Mobile MNO approvals beside others. 26.0 x 24.0 x 2.6 mm, 150 pcs/reel
LARA-R203-03B	Module supporting LTE Cat 1 bands 2 / 4 / 12. Mainly designed for operation in America, with AT&T and T-Mobile MNO approvals beside others. 26.0 x 24.0 x 2.6 mm, 150 pcs/reel
LARA-R204-02B	Module supporting LTE Cat 1 bands 4 / 13. Mainly designed for operation in America, with Verizon MNO approval. 26.0 x 24.0 x 2.6 mm, 150 pcs/reel
LARA-R211-02B	Module supporting LTE Cat 1 bands 3 / 7 / 20, €GPRS bands 900 / 1800. Mainly designed for operation in EMEA, with Vodafone approval beside others 26.0 x 24.0 x 2.6 mm, 150 pcs/reel
LARA-R220-62B	Module supporting LTE Cat 1 bands 1 / 19. Mainly designed for operation in Japan, with NTT DoCoMo MNO approval. 26.0 x 24.0 x 2.6 mm, 150 pcs/reel
LARA-R280-02B	Module supporting LTE Cat 1 bands 3 / 8 / 28, HSPA band 1. Mainly designed for operation in Asia-Pacific. 26.0 x 24.0 x 2.6 mm, 150 pcs/reel
LARA-R281-02B	Module supporting LTE Cat 1 bands 1 / 3 / 8 / 20 / 28, HSPA band 1. Mainly designed for operation in EMEA. 26.0 x 24.0 x 2.6 mm, 150 pcs/reel

Table 41: Product ordering codes

Appendix

A Glossary

Abbreviation	Definition
8-PSK	8 Phase-Shift Keying modulation
ADC	Analog to Digital Converter
APAC	Asia-Pacific
CSFB	Circuit Switched Fall-Back
DDC	Display Data Channel (I2C compatible) Interface
DL	Down-link (Reception)
DNS	Domain Name System
EMEA	Europe, the Middle East and Africa
ERS	External Reset Input Signal
ESD	Electrostatic Discharge
FOAT	Firmware update Over AT commands
FOTA	Firmware update Over The Air
FW	Firmware
GDI	Generic Digital Interfaces (power domain)
GMSK	Gaussian Minimum-Shift Keying modulation
GND	Ground
GNSS	Global Navigation Satellite System
GPIO	General Purpose Input Output
HSDPA	High Speed Downlink Packet Access
HSIC	High Speed Inter Chip
HSUPA	High Speed Uplink Packet Access
I2C	Inter-Integrated Circuit Interface
I2S	Inter-IC Sound Interface
IMEI	International Mobile Equipment Identity
IMS	IP Multimedia Subsystem
LGA	Land Grid Array
LTE	Long Term Evolution
MNO	Mobile Network Operator
PCN	Product Change Notification / Sample Delivery Note / Information Note
PD	Pull-Down
POS	Power-On Input Signal
PU	Pull-Up
RMC	Reference Measurement Channel
SDIO	Secure Digital Input Output
UL	Up-link (Transmission)
UMTS	Universal Mobile Telecommunications System
VoLTE	Voice over LTE

Table 42: Explanation of the abbreviations and terms used

Related documentation

- [1] u-blox AT commands manual, [UBX-13002752](#)
- [2] u-blox LARA-R2 series system integration manual, [UBX-16010573](#)
- [3] u-blox Android RIL source code application note, [UBX-13002041](#)
- [4] u-blox GNSS implementation application note, [UBX-13001849](#)
- [5] u-blox Mux implementation application note, [UBX-13001887](#)
- [6] u-blox package information user guide, [UBX-14001652](#)
- [7] 3GPP TS 27.007 - AT command set for User Equipment (UE)
- [8] 3GPP TS 27.005 - Use of Data Terminal Equipment - Data Circuit terminating Equipment (DTE - DCE) interface for Short Message Service (SMS) and Cell Broadcast Service (CBS)
- [9] 3GPP TS 27.010 - Terminal Equipment to User Equipment (TE-UE) multiplexer protocol
- [10] 3GPP TS 26.267 - Technical specification group services and system aspects; eCall data transfer; In-band modem solution; general description
- [11] 3GPP TS 36.521-1 - Evolved Universal Terrestrial Radio Access; User Equipment conformance specification; radio transmission and reception; part 1: conformance testing
- [12] 3GPP TS 34.121-1 - User Equipment conformance specification; radio transmission and reception (FDD); part 1: conformance specification
- [13] 3GPP TS 51.010-1 - Mobile Station conformance specification; part 1: conformance specification
- [14] ITU-T recommendation V24, 02-2000. List of definitions for interchange circuits between Data Terminal Equipment (DTE) and Data Connection Equipment (DCE)
- [15] Universal Serial Bus specification, revision 2.0, <https://www.usb.org/>
- [16] High-Speed Inter-Chip USB specification, version 1.0, <https://www.usb.org/>
- [17] I2C-bus specification and user manual – UM10204 – NXP semiconductors, <https://www.nxp.com/docs/en/user-guide/UM10204.pdf>
- [18] IEC 60079-0 - Explosive atmospheres, part 0: equipment general requirements
- [19] IEC 60079-11 - Explosive atmospheres, part 11: equipment protection by intrinsic safety 'i'
- [20] IEC 60079-26 - Explosive atmospheres, part 26: equipment with EPL Ga

 For regular updates to u-blox documentation and to receive product change notifications, register on our homepage (www.u-blox.com).

Revision history

Revision	Date	Name	Comments
R01	03-Mar-2016	sses	Initial release
R02	31-May-2016	sses	Document applicability updated to LARA-R204 and LARA-R211. Improved description of VCC, power-on, reset, host select, UART, USB, HSIC, GPIO pins.
R03	15-Jul-2016	sses	Added description of reels and tapes. Added current consumption and RF performance figures. Updated description of power-on, reset, UART, USB pins.
R04	11-Oct-2016	sses	Updated audio support. Updated PWR_ON, ANT_DET, GPIO and clock output description. Added 2G current consumption figures and remark in mechanical.
R05	25-Nov-2016	sses	Updated power-on and power-off sections.
R06	20-Dec-2016	sses	"Disclosure restriction" replaces "Document status" on page 2 and document footer. Extended the document applicability to LARA-R203-02B.
R07	17-Mar-2017	sses	Updated GPRS / EDGE multi-slot class. Added AC characteristics of I2S pins and other minor characteristics. Updated VUSB_DET pin logical levels input ranges. Extended the document applicability to LARA-R202-02B.
R08	19-Apr-2017	sses	Updated extended VCC range of LARA-R211 modules. Updated LARA-R204-02B and LARA-R211-02B product status.
R09	29-May-2017	sses	Updated LARA-R203-02B product status to engineering sample.
R10	30-Jun-2017	sses	Updated LARA-R202-02B product status. Extended the document applicability to LARA-R220 and LARA-R280.
R11	16-Aug-2017	sses	Updated LARA-R203-02B, LARA-R220-62B, LARA-R280-02B product status.
R12	22-Sep-2017	sses	Updated LARA-R202-02B product status.
R13	27-Oct-2017	sses	Updated LARA-R202-02B, LARA-R220-62B, LARA-R280-02B product status.
R14	15-Dec-2017	lpah	Updated LARA-R280-02B product status.
R15	27-May-2018	lpah	Extended document applicability to LARA-R202-02B-01, LARA-R203-02B-01, LARA-R204-02B-01 and LARA-R280-02B-01.
R16	31-Aug-2018	lpah	Extended document applicability to LARA-R204-02B-02, LARA-R220-62B-01, LARA-R280-02B-02. Added Rogers certification for LARA-R203.
R17	02-Oct-2018	lpah	Added T-Mobile certification for LARA-R202.
R18	20-Dec-2018	lpah / sses	Extended document applicability to LARA-R202-02B-02, LARA-R203-02B-02, LARA-R211-02B-02, LARA-R220-62B-02, LARA-R280-02B-03. Updated pin 1 indicator description. Mechanical dimension updated.
R19	10-Jun-2019	lpah / sses	Extended document applicability to LARA-R202-02B-03, LARA-R203-02B-03. Updated LARA-R211-02B-02 product status. Updated the RoHS statement. Added parameters for ATEX applications
R20	30-Aug-2019	lpah / sses	Extended document applicability to LARA-R202-82B, LARA-R220-62B-03, LARA-R280-02B-04
R21	25-Sep-2019	lpah	LARA-R220-62B-02, LARA-R220-62B-03, LARA-R280-02B-03, LARA-R280-02B-04 product status update
R22	21-Nov-2019	lpah	LARA-R202-82B product status update. Minor other corrections. Added LARA-R202 Rogers certification.
R23	17-Jan-2020	lpah	Extended document applicability to LARA-R203-02B-34.
R24	10-Jun-2020	lpah	LARA-R220-62B-03, LARA-R280-02B-04 application version update. Added LARA-R211 Deutsche Telekom certification. Minor other clarifications.
R25	29-Jul-2020	sses	Extended document applicability to LARA-R211-02B-03, LARA-R281-02B
R26	09-Oct-2020	sses	Updated LARA-R281-02B product status. Minor other clarifications.
R27	30-Mar-2021	sses	Extended document applicability to LARA-R202-03B, LARA-R203-03B
R28	23-Jun-2021	sses	Extended document applicability to LARA-R202-02B-04, LARA-R202-82B-01, LARA-R203-02B-04, LARA-R203-02B-35, LARA-R211-02B-04

Contact

For complete contact information, visit us at www.u-blox.com.

u-blox Offices

North, Central and South America

u-blox America, Inc.

Phone: +1 703 483 3180
Email: info_us@u-blox.com

Regional Office West Coast:

Phone: +1 408 573 3640
Email: info_us@u-blox.com

Technical Support:

Phone: +1 703 483 3185
Email: support@u-blox.com

Headquarters

Europe, Middle East, Africa

u-blox AG

Phone: +41 44 722 74 44
Email: info@u-blox.com
Support: support@u-blox.com

Asia, Australia, Pacific

u-blox Singapore Pte. Ltd.

Phone: +65 6734 3811
Email: info_ap@u-blox.com
Support: support_ap@u-blox.com

Regional Office Australia:

Phone: +61 3 9566 7255
Email: info_anz@u-blox.com
Support: support_ap@u-blox.com

Regional Office China (Beijing):

Phone: +86 10 68 133 545
Email: info_cn@u-blox.com
Support: support_cn@u-blox.com

Regional Office China (Chongqing):

Phone: +86 23 6815 1588
Email: info_cn@u-blox.com
Support: support_cn@u-blox.com

Regional Office China (Shanghai):

Phone: +86 21 6090 4832
Email: info_cn@u-blox.com
Support: support_cn@u-blox.com

Regional Office China (Shenzhen):

Phone: +86 755 8627 1083
Email: info_cn@u-blox.com
Support: support_cn@u-blox.com

Regional Office India:

Phone: +91 80 405 092 00
Email: info_in@u-blox.com
Support: support_in@u-blox.com

Regional Office Japan (Osaka):

Phone: +81 6 6941 3660
Email: info_jp@u-blox.com
Support: support_jp@u-blox.com

Regional Office Japan (Tokyo):

Phone: +81 3 5775 3850
Email: info_jp@u-blox.com
Support: support_jp@u-blox.com

Regional Office Korea:

Phone: +82 2 542 0861
Email: info_kr@u-blox.com
Support: support_kr@u-blox.com

Regional Office Taiwan:

Phone: +886 2 2657 1090
Email: info_tw@u-blox.com
Support: support_tw@u-blox.com

Mouser Electronics

Authorized Distributor

Click to View Pricing, Inventory, Delivery & Lifecycle Information:

[Mikroe:](#)

[MIKROE-3350](#)