



Is Now Part of



ON Semiconductor®

To learn more about ON Semiconductor, please visit our website at
www.onsemi.com

Please note: As part of the Fairchild Semiconductor integration, some of the Fairchild orderable part numbers will need to change in order to meet ON Semiconductor's system requirements. Since the ON Semiconductor product management systems do not have the ability to manage part nomenclature that utilizes an underscore (_), the underscore (_) in the Fairchild part numbers will be changed to a dash (-). This document may contain device numbers with an underscore (_). Please check the ON Semiconductor website to verify the updated device numbers. The most current and up-to-date ordering information can be found at www.onsemi.com. Please email any questions regarding the system integration to Fairchild_questions@onsemi.com.

ON Semiconductor and the ON Semiconductor logo are trademarks of Semiconductor Components Industries, LLC dba ON Semiconductor or its subsidiaries in the United States and/or other countries. ON Semiconductor owns the rights to a number of patents, trademarks, copyrights, trade secrets, and other intellectual property. A listing of ON Semiconductor's product/patent coverage may be accessed at www.onsemi.com/site/pdf/Patent-Marking.pdf. ON Semiconductor reserves the right to make changes without further notice to any products herein. ON Semiconductor makes no warranty, representation or guarantee regarding the suitability of its products for any particular purpose, nor does ON Semiconductor assume any liability arising out of the application or use of any product or circuit, and specifically disclaims any and all liability, including without limitation special, consequential or incidental damages. Buyer is responsible for its products and applications using ON Semiconductor products, including compliance with all laws, regulations and safety requirements or standards, regardless of any support or applications information provided by ON Semiconductor. "Typical" parameters which may be provided in ON Semiconductor data sheets and/or specifications can and do vary in different applications and actual performance may vary over time. All operating parameters, including "Typicals" must be validated for each customer application by customer's technical experts. ON Semiconductor does not convey any license under its patent rights nor the rights of others. ON Semiconductor products are not designed, intended, or authorized for use as a critical component in life support systems or any FDA Class 3 medical devices or medical devices with a same or similar classification in a foreign jurisdiction or any devices intended for implantation in the human body. Should Buyer purchase or use ON Semiconductor products for any such unintended or unauthorized application, Buyer shall indemnify and hold ON Semiconductor and its officers, employees, subsidiaries, affiliates, and distributors harmless against all claims, costs, damages, and expenses, and reasonable attorney fees arising out of, directly or indirectly, any claim of personal injury or death associated with such unintended or unauthorized use, even if such claim alleges that ON Semiconductor was negligent regarding the design or manufacture of the part. ON Semiconductor is an Equal Opportunity/Affirmative Action Employer. This literature is subject to all applicable copyright laws and is not for resale in any manner.



September 2015

FSV10100V

10 A, 100 V Ultra-Low VF Schottky Rectifier

Features

- Ultra-Low Forward Voltage Drop
- Low Thermal Resistance
- Very Low Profile: Typical Height of 1.1 mm
- Trench Schottky Technology
- RoHS Compliant
- Green Molding Compound as per IEC61249 Standard
- Lead Free in Compliance with EU RoHS 2011/65/EU Directive
- Qualified per AEC-Q101 Rev. C Standard

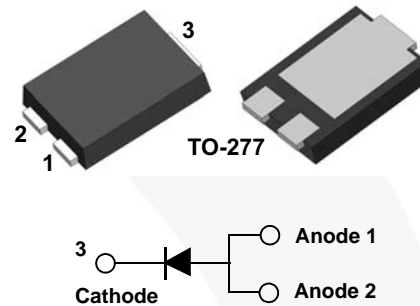

Ordering Information

Part Number	Top Mark	Package	Packing Method
FSV10100V	FSV10100V	TO-277 3L	Tape and Reel

Absolute Maximum Ratings

Stresses exceeding the absolute maximum ratings may damage the device. The device may not function or be operable above the recommended operating conditions and stressing the parts to these levels is not recommended. In addition, extended exposure to stresses above the recommended operating conditions may affect device reliability. The absolute maximum ratings are stress ratings only. Values are at $T_A = 25^\circ\text{C}$ unless otherwise noted.

Symbol	Parameter	Value	Unit
V_{RRM}	Peak Repetitive Reverse Voltage	100	V
V_{RWM}	Working Peak Reverse Voltage	100	V
V_{RMS}	RMS Reverse Voltage	70	V
V_R	DC Blocking Voltage	100	V
$I_{F(AV)}$	Average Rectified Peak Forward Surge Current	10	A
I_{FSM}	Non-Repetitive Peak Forward Surge Current	180	A
T_J	Operating Junction Temperature Range	-55 to +150	$^\circ\text{C}$
T_{STG}	Storage Temperature Range	-55 to +150	$^\circ\text{C}$

FSV10100V — 10 A, 100 V Ultra-Low VF Schottky Rectifier

Thermal Characteristics⁽¹⁾

Values are at $T_A = 25^\circ\text{C}$ unless otherwise noted.

Symbol	Parameter	Minimum Land Pattern	Maximum Land Pattern	Unit
$R_{\theta JA}$	Junction-to-Ambient Thermal Resistance	100	40	$^\circ\text{C}/\text{W}$
Ψ_{JL}	Junction-to-Lead Thermal Characteristics, Thermocouple Soldered to Anode	15	12	$^\circ\text{C}/\text{W}$
	Junction-to-Lead Thermal Characteristics, Thermocouple Soldered to Cathode	6	5	

Note:

- The thermal resistances ($R_{\theta JA}$ & Ψ_{JL}) are characterized with device mounted on the following FR4 printed circuit boards, as shown in Figure 1 and Figure 2. PCB size: 76.2 x 114.3 mm. Minimum land pattern size: 4.9 x 4.8 mm (big pattern, x1), 1.4 x 1.52 mm (small pattern, x2). Maximum land pattern size: 30 x 30 mm (pattern, x2). Force line trace size = 55 mils, sense line trace size = 4 mils.



Figure 1. Minimum Land Pattern of 2 oz Copper

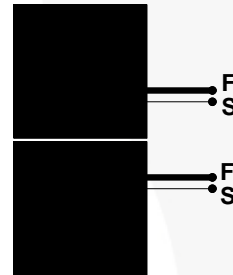

Figure 2. Maximum Land Pattern of 2 oz Copper

Electrical Characteristics

Values are at $T_A = 25^\circ\text{C}$ unless otherwise noted.

Symbol	Parameter	Conditions	Min.	Typ.	Max.	Unit
BV_R	Breakdown Voltage	$I_R = 0.5 \text{ mA}$	100			V
V_F	Forward Voltage Drop	$I_F = 5 \text{ A}$		0.513		V
		$I_F = 5 \text{ A}, T_A = 125^\circ\text{C}$		0.463		
		$I_F = 10 \text{ A}$		0.625	0.670	
		$I_F = 10 \text{ A}, T_A = 125^\circ\text{C}$		0.575	0.600	
I_R	Reverse Current	$V_R = 70 \text{ V}$		0.0072		mA
		$V_R = 70 \text{ V}, T_A = 125^\circ\text{C}$		6.486		
		$V_R = 100 \text{ V}$		0.0165	0.060	
		$V_R = 100 \text{ V}, T_A = 125^\circ\text{C}$		16.72	20	
C_J	Junction Capacitance	$V_R = 4 \text{ V}, f = 1 \text{ MHz}$		796		pF
T_{rr}	Reverse Recovery Time	$I_F = 0.5 \text{ A}, I_R = 1 \text{ A}, I_{rr} = 0.25 \text{ A}$		22.94		ns

Typical Performance Characteristics

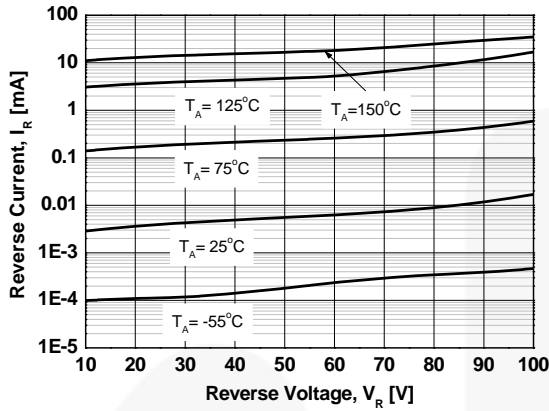

Figure 3. Typical Reverse Characteristics

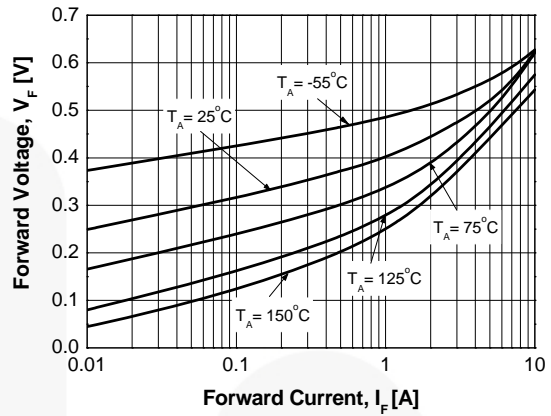

Figure 4. Typical Forward Characteristics

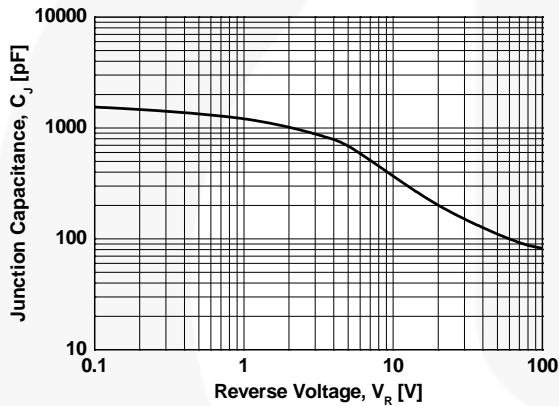

Figure 5. Typical Junction Capacitance

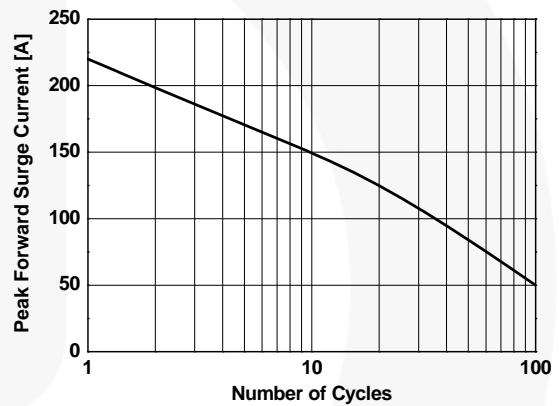

Figure 6. Maximum Non-repetitive Peak Forward Surge Current

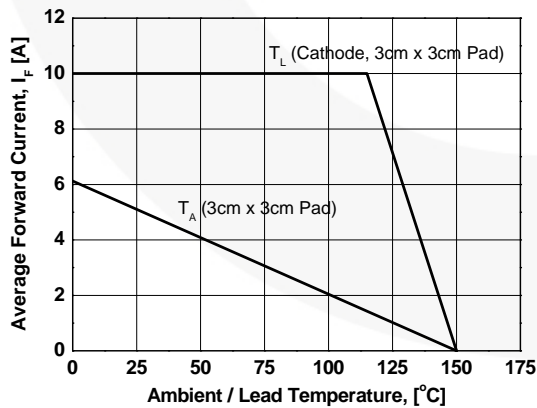
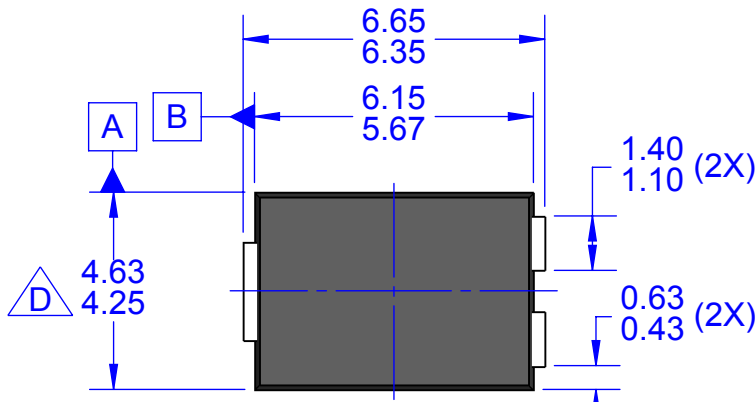
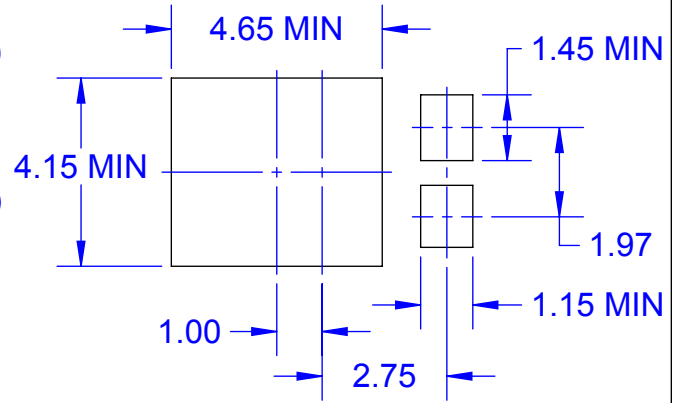

Figure 7. Forward Current Derating Curve



TOP VIEW



LAND PATTERN RECOMMENDATION

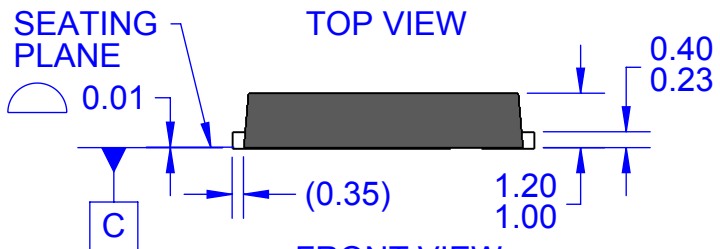

FRONT VIEW

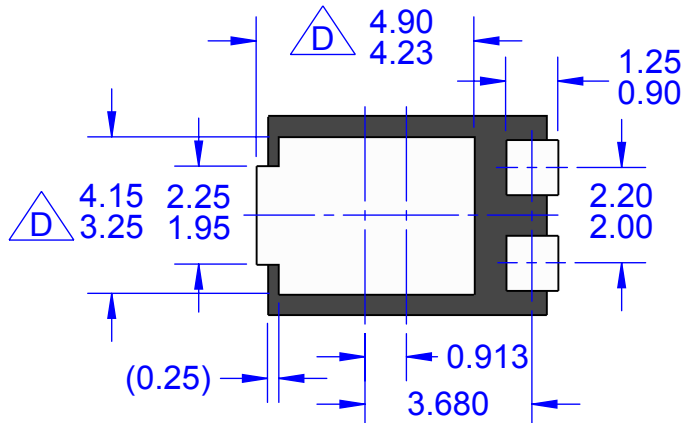

BOTTOM VIEW

NOTES: UNLESS OTHERWISE SPECIFIED

A. PACKAGE REFERENCE: JEDEC TO-277
 B. DIMENSIONS ARE EXCLUSIVE OF BURRS, MOLD FLASH, AND TIE BAR EXTRUSIONS.

C. ALL DIMENSIONS ARE IN MILLIMETERS.

D DOES NOT COMPLY TO JEDEC STANDARD VALUE.

E. DRAWING FILENAME: MKT-TO277A03rev5

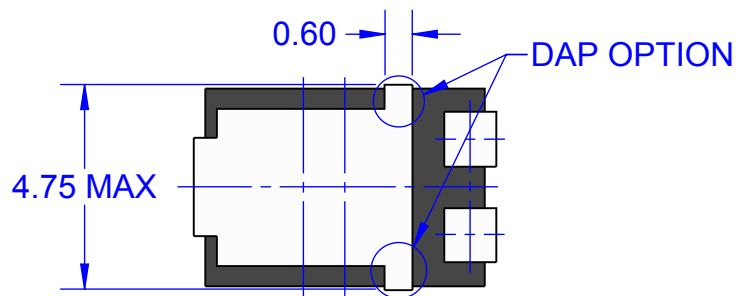

BOTTOM VIEW - DAP OPTION



ON Semiconductor and  are trademarks of Semiconductor Components Industries, LLC dba ON Semiconductor or its subsidiaries in the United States and/or other countries. ON Semiconductor owns the rights to a number of patents, trademarks, copyrights, trade secrets, and other intellectual property. A listing of ON Semiconductor's product/patent coverage may be accessed at www.onsemi.com/site/pdf/Patent-Marking.pdf. ON Semiconductor reserves the right to make changes without further notice to any products herein. ON Semiconductor makes no warranty, representation or guarantee regarding the suitability of its products for any particular purpose, nor does ON Semiconductor assume any liability arising out of the application or use of any product or circuit, and specifically disclaims any and all liability, including without limitation special, consequential or incidental damages. Buyer is responsible for its products and applications using ON Semiconductor products, including compliance with all laws, regulations and safety requirements or standards, regardless of any support or applications information provided by ON Semiconductor. "Typical" parameters which may be provided in ON Semiconductor data sheets and/or specifications can and do vary in different applications and actual performance may vary over time. All operating parameters, including "Typicals" must be validated for each customer application by customer's technical experts. ON Semiconductor does not convey any license under its patent rights nor the rights of others. ON Semiconductor products are not designed, intended, or authorized for use as a critical component in life support systems or any FDA Class 3 medical devices or medical devices with a same or similar classification in a foreign jurisdiction or any devices intended for implantation in the human body. Should Buyer purchase or use ON Semiconductor products for any such unintended or unauthorized application, Buyer shall indemnify and hold ON Semiconductor and its officers, employees, subsidiaries, affiliates, and distributors harmless against all claims, costs, damages, and expenses, and reasonable attorney fees arising out of, directly or indirectly, any claim of personal injury or death associated with such unintended or unauthorized use, even if such claim alleges that ON Semiconductor was negligent regarding the design or manufacture of the part. ON Semiconductor is an Equal Opportunity/Affirmative Action Employer. This literature is subject to all applicable copyright laws and is not for resale in any manner.

PUBLICATION ORDERING INFORMATION

LITERATURE FULFILLMENT:

Literature Distribution Center for ON Semiconductor
19521 E. 32nd Pkwy, Aurora, Colorado 80011 USA
Phone: 303-675-2175 or 800-344-3860 Toll Free USA/Canada
Fax: 303-675-2176 or 800-344-3867 Toll Free USA/Canada
Email: orderlit@onsemi.com

N. American Technical Support: 800-282-9855 Toll Free
USA/Canada
Europe, Middle East and Africa Technical Support:
Phone: 421 33 790 2910
Japan Customer Focus Center
Phone: 81-3-5817-1050

ON Semiconductor Website: www.onsemi.com
Order Literature: <http://www.onsemi.com/orderlit>
For additional information, please contact your local
Sales Representative