

МОЩНЫЙ СВЕТОДИОД ARPL-1W-EPL IR850 60DEG



FEATURES

- low voltage operation
- Instant light
- Long operating life

APPLICATIONS

- Smart home device
- Infrared communication
- Plant lighting, aquatic lighting)
- For infrared camera with night vision function, infrared monitor, infrared therapeutic apparatus

PACKAGE DIMENSIONS

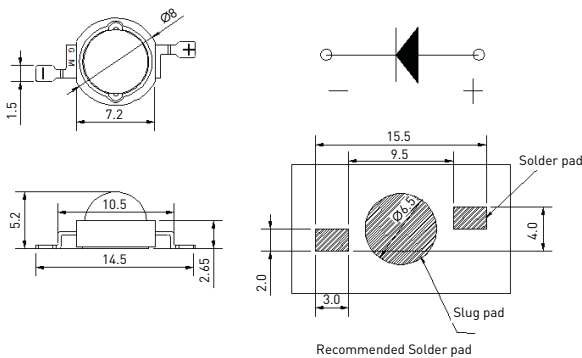

Notes: All dimensions in mm tolerance is ± 0.1 mm unless otherwise noted

PARAMETERS

ABSOLUTE MAXIMUM RATINGS (AT $T_A = +25^\circ\text{C}$)

Parameter	Symbol	Rating	Unit
DC Forward Current	I_F	700	mA
Peak pulse Current*	I_{FP}	1000	mA
Reverse Voltage	V_R	5	V
Power Dissipation (250 eter)	P_D	3	W
Operating Temperature Range	T_{OPR}	-30... +75	°C
Storage Temperature Range	T_{STG}	-40... +85	°C
LED Junction Temperature	T_J	125	°C

* 1/10 Duty Cycle 0.1 ms Pulse Width.

MASS PRODUCTION LIST

Part No.	λ_p (NM) Min	λ_p (NM) Typ	λ_p (NM) Max	(mW) Min	(mW) Max	Condition
	940	945	950	60	70	$I_F=350\text{mA}$
	930	935	940	60	70	$I_F=350\text{mA}$
GP-1WR3-105-G38G	845	850	855	180	220	$I_F=350\text{mA}$
	830	845	850	180	220	$I_F=350\text{mA}$
	740	745	750	180	220	$I_F=350\text{mA}$
	730	735	740	180	220	$I_F=350\text{mA}$

ELECTRICAL/OPTICAL CHARACTERISTICS-WHITE (AT $T_A = +25^\circ\text{C}$)

Parameter	Symbol	Min	Avg.	Max	Units	Conditions
Forward Voltage	V_F	1.6	—	2.0	V	$I_F=350\text{mA}$
Thermal Resistance Junction To Board	$R_{\theta_{J-B}}$	—	8	—	°C/W	$I_F=350\text{mA}$
Temperature Coefficient of Forward Voltage	$\Delta V_F/\Delta T$	—	-2	—	mV/°C	$I_F=350\text{mA}$
Reverse Current	I_R	—	—	10	μA	$V_F=5\text{V}$
Viewing Angle ^[1]	$2\theta_{1/2}$	—	140	—	Deg	$I_F=350\text{mA}$

Note:

1. $2\theta_{1/2}$ is the angle from optical centerline where the luminous intensity is 1/2 the optical centerline value.
2. The above luminous flux measurement allowance tolerance is $\pm 10\%$.
3. The above forward voltage measurement allowance tolerance is ± 0.1 V.
4. The wavelength measurement error shown above is plus or minus 0.1 nm

TYPICAL OPTICAL/ELECTRICAL CHARACTERISTICS CURVES

($T_A = +25\text{ }^\circ\text{C}$, Unless Otherwise Noted)

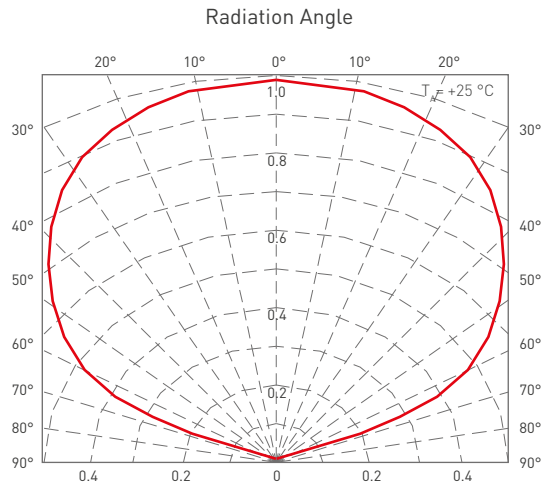
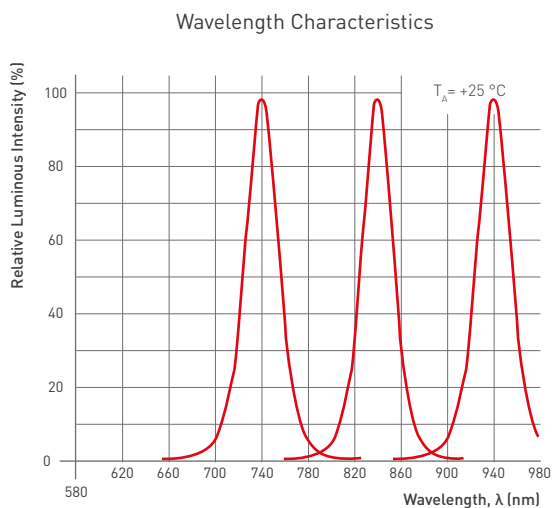
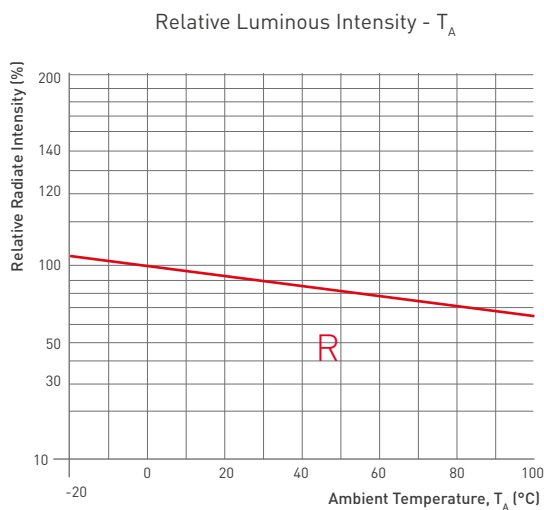
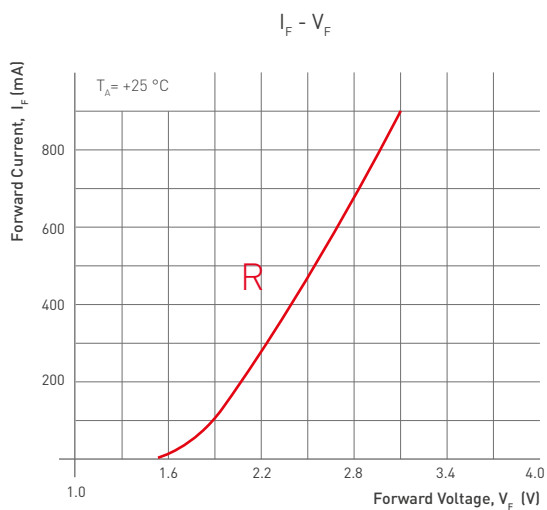
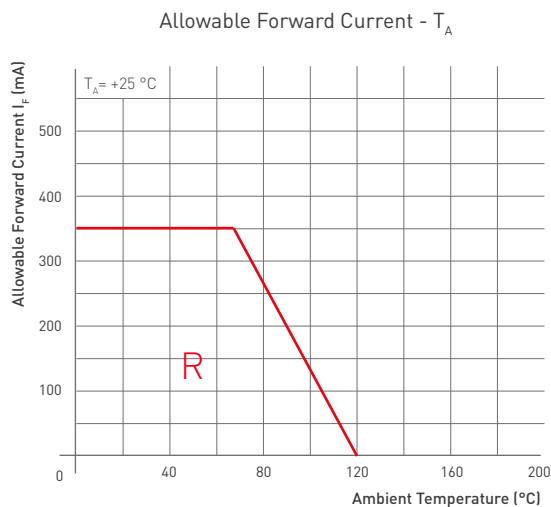
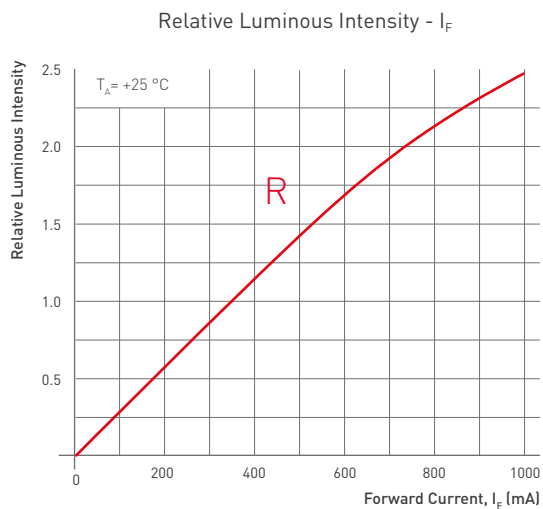

RELIABILITY TEST STANDARDS

Type	Test Item	REF. Standard	Test condition	Duration	Sample count	Accept
	Temperature Cycle	JESD22-A104-A	-40... +25... +100... +25 °C 30 min, 5 min, 30 min, 5 min	100 cycles	22	0/22
	Thermal shock	JESD22-A106	-40... +100 °C 30 min, 30 min	100 cycles	22	0/22
	High Temperature Storage	JEITA ED-4701 200 201	TA=100±5 °C	1000 Hrs	22	0/22
	Low Temperature Storage	JEITA ED-4701 200 202	TA=-40±5 °C	1000 Hrs	22	0/22
	Humidity Heat Storage	JIS C 7021(1977) B-11	TA=60 °C RH=85%	1000 Hrs	22	0/22
	Life test	JESD22-A108-A	TA=25 °C If=350mA	1000 Hrs	22	0/22
	High humidity Heat life test	JESD22-A101	TA=60 °C RH=85% IF=350mA	1000 Hrs	22	0/22
	Resistance to soldering Heat	JESD22-A113	IR soldering 245 °C/10sec	1 time	22	0/22

PACKING STANDARD

Normal packing weight: 0.041kg/each tube ,0.877kg/1K

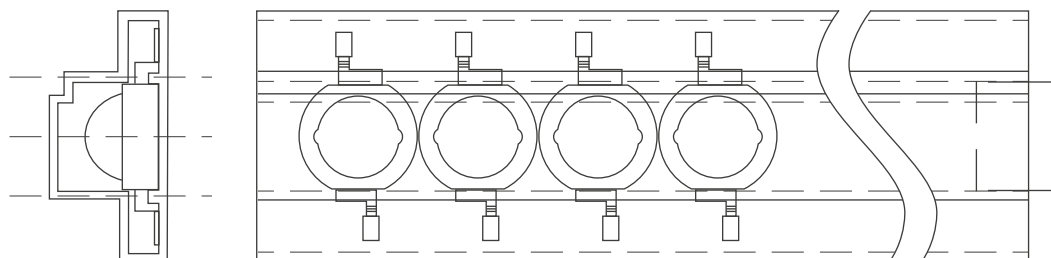

50 Pcs Tube

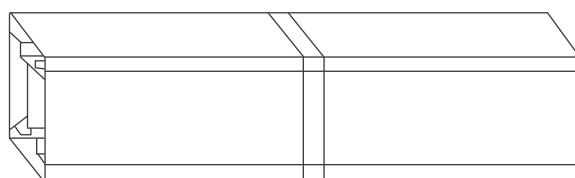

4 Tube

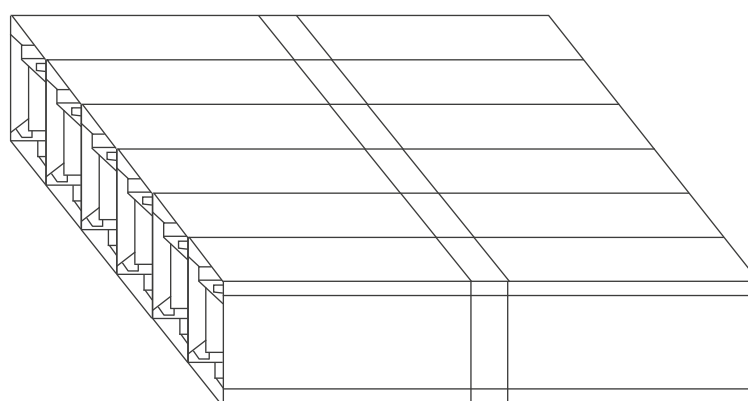

20 Tube

PRODUCT USE DESCRIPTION

First, storage:

1. In order to avoid moisture absorption, the product should be stored in a drying cabinet with desiccant, storage temperature: 5 °C...30 °C, humidity: ≤ 60% HR;
2. After six months of storage, it is recommended to use it again after splitting the color separation to prevent the photoelectric parameters from changing.

Second, if the product is silicone package

1. It is recommended to dry and store the product after sealing for more than six months. The drying condition is: 65 °C ±5 °C for 10 hours;
2. The product needs to be used within 24 hours after opening, otherwise it needs to be baked at 65 °C for 4-6h before reflow soldering;
3. Do not press on the silicone surface with any sharp objects (such as tweezers). Do not leave fingerprints on the surface of the silicone. The front side of the silicone body is subjected to a pressing force of less than 2 Newtons, and the number of pressing times is less than 3 times; the side of the silicone body is subjected to a pressing force of less than 1.5 Newtons, and the number of pressing times is less than 3 times. Pick up the material correctly (as shown below)

Third, after reflow soldering, fast cooling is not allowed.

Fourth, soldering by hand soldering iron, the condition is 300 °C / 3 sec.

5th. It is forbidden to solder on the deformed PCB board.

6th. The product shall not be exposed to water, oil or organic solutions.

7th. The product use operating current size value should consider the LED junction temperature.

8th. Repackage unused products. Store the moisture-proof bag in a dry place after sealing.

9th. The product size can be changed without notice.

10th. Anti-static requirements: When using the product, you must wear anti-static ring or anti-static gloves. All equipment, devices and machines must be grounded effectively.

11th. When the LED is working, the temperature of the PCB should not exceed 60 °C.

12th. reflow soldering precautions [if reflow soldering products]

1. Scrape the thermal paste on the aluminum substrate. Before soldering the solder paste, stir the solder paste clockwise for 10-15 minutes. Place the aluminum substrate on the solder paste tool. The solder paste should be evenly coated and the thickness should be suitable.
2. The scraping steel stencil needs to be made into a cross to allow the air to circulate, so as to avoid the poor heat dissipation of the LED light source caused by the solder paste lifting;
3. Note that the lamp should be flattened, and the two pins of the LED light source should be mounted on the pad of the aluminum substrate;
4. The aluminum substrate with the solder paste should be fully equipped with the light source within 2 hours. After the light source is mounted on the aluminum substrate, the operator should self-check whether the light source is installed (cannot be reversed, the bottom of the light source is suspended) and tilted 45 degrees. Check each light source at this angle;
5. Temperature settign of reflow sodlring oven:(suggest max 180-200 degree)

Reference of 8 Temperaturt Zones:

Temp Zone	Zone 1	Zone 2	Zone 3	Zone 4	Zone 5	Zone 6	Zone 7	Zone 8
Temperature	90	105	120	130	145	180	145	130
Time (s)	40	40	40	40	40	40	40	40

Totally Time: 5.3Min

Speed: 75cm/min

Preheating Zone: 80S Temp Zone 1-2

Constant temperature zone: 120S Temp Zone 3-5

Welding Zone: 80S Temp Zone 6-7

Cooling Zone: 40S Since Temp Zone 8 (if it is 10 temp Zones, Temp 9 and 10 may not set up the temperature, just as the cooling zone)

6. After the reflow soldering, the lens and the filling glue will be layered, and the mirror surface is normal, which does not affect any use and performance;
7. After the reflow soldering, check whether the light source is at the pad position, and there is no eccentricity. Otherwise, the wire will be broken during the second secondary lens, resulting in an open circuit.

13. Anti-vulcanization, chlorination, bromination and other treatments:

In a closed, high temperature environment, the luminaire may contain substances such as sulfur/chlorine/bromine, which will volatilize into gases and corrode the LED source. Because the LED sealed silica gel has a porous structure, it undergoes a vulcanization reaction with the silver plating layer of the light source. After the vulcanization reaction of the LED light source, the functional area of the product will be blackened, the luminous flux will gradually decrease until it is slightly bright, the color temperature will drift significantly, and the LED light source will eventually fail. It is recommended that the sulphur emission test be performed first to ensure that the LED light source operates in a sulfur-free/chlorine/bromine-free environment.