

**Mid-Power LED - 3528 Series**

STW8A12D – 0.5W (Cool, Neutral, Warm)

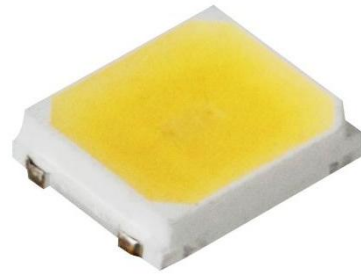

## Product Brief

### Description

- This White Colored surface-mount LED comes in standard package dimension. Package Size: 3.5x2.8x0.7mm
- It has a substrate made up of a molded plastic reflector sitting on top of a lead frame.
- The die is attached within the reflector cavity and the cavity is encapsulated by silicone.
- The package design coupled with careful selection of component materials allow these products to perform with high reliability.

### Features and Benefits

- Market Standard 3528 Package Size
- High Color Quality, CRI Min. 80
- RoHS compliant

### Key Applications

- Interior lighting
- General lighting
- Indoor and outdoor displays
- Architectural / Decorative lighting

**Table 1. Product Selection Table**

| Part Number | CCT           |       |       |       |
|-------------|---------------|-------|-------|-------|
|             | Color         | Min.  | Typ.  | Max.  |
| STW8A12D    | Cool White    | 4700K | 5600K | 7000K |
| STW8A12D    | Neutral White | 3700K | 4200K | 4700K |
| STW8A12D    | Warm White    | 2600K | 3000K | 3700K |

# Table of Contents

| <b>Index</b> |                                     |    |
|--------------|-------------------------------------|----|
| •            | Product Brief                       | 1  |
| •            | Table of Contents                   | 2  |
| •            | Performance Characteristics         | 3  |
| •            | Characteristics Graph               | 5  |
| •            | Color Bin Structure                 | 11 |
| •            | Mechanical Dimensions               | 16 |
| •            | Recommended Solder Pad              | 17 |
| •            | Reflow Soldering Characteristics    | 18 |
| •            | Emitter Tape & Reel Packaging       | 19 |
| •            | Product Nomenclature                | 21 |
| •            | Handling of Silicone Resin for LEDs | 22 |
| •            | Precaution For Use                  | 23 |
| •            | Company Information                 | 26 |

## Performance Characteristics

**Table 2. Product Selection Guide,  $I_F = 150\text{mA}$ ,  $T_j = 25^\circ\text{C}$ , RH30%**

| Part Number | CCT (K) <sup>[1]</sup> | RANK | Luminous Intensity <sup>[2]</sup> |      | Luminous Flux <sup>[3]</sup> |      | CRI   |
|-------------|------------------------|------|-----------------------------------|------|------------------------------|------|-------|
|             | Typ.                   |      | $I_V$ (cd)                        |      | $\Phi_V$ (lm)                |      | $R_a$ |
|             |                        |      | Min                               | Max  | Min                          | Max  | Min.  |
| STW8A12D    | 6500                   | J16  | 16                                | 18   | 49.6                         | 55.8 | 80    |
|             |                        | J18  | 18                                | 20   | 55.8                         | 62.0 | 80    |
|             |                        | K20  | 20                                | 22   | 62.0                         | 68.2 | 80    |
|             | 5600                   | J16  | 16                                | 18   | 49.6                         | 55.8 | 80    |
|             |                        | J18  | 18                                | 20   | 55.8                         | 62.0 | 80    |
|             |                        | K20  | 20                                | 22   | 62.0                         | 68.2 | 80    |
|             | 5000                   | J18  | 18                                | 20   | 55.8                         | 62.0 | 80    |
|             |                        | K20  | 20                                | 22   | 62.0                         | 68.2 | 80    |
|             |                        | K22  | 22                                | 24   | 68.2                         | 74.4 | 80    |
|             | 4500                   | J18  | 18                                | 20   | 54.9                         | 61.0 | 80    |
|             |                        | K20  | 20                                | 22   | 61.0                         | 67.1 | 80    |
|             |                        | K22  | 22                                | 24   | 68.2                         | 74.4 | 80    |
|             | 4000                   | J18  | 18                                | 20   | 54.9                         | 61.0 | 80    |
|             |                        | K20  | 20                                | 22   | 61.0                         | 67.1 | 80    |
|             |                        | K22  | 22                                | 24   | 68.2                         | 74.4 | 80    |
|             | 3500                   | J16  | 16                                | 18   | 48.0                         | 54.0 | 80    |
|             |                        | J18  | 18                                | 20   | 54.0                         | 60.0 | 80    |
|             |                        | K20  | 20                                | 22   | 60.0                         | 66.0 | 80    |
|             | 3000                   | J16  | 16                                | 18   | 48.0                         | 54.0 | 80    |
|             |                        | J18  | 18                                | 20   | 54.0                         | 60.0 | 80    |
|             | 2700                   | J16  | 16                                | 18   | 48.0                         | 54.0 | 80    |
|             |                        | J18  | 18                                | 20   | 54.0                         | 60.0 | 80    |
|             | 2450                   | J16  | 16.0                              | 18.0 | 48.0                         | 54.0 | 80    |
|             |                        | J18  | 18.0                              | 20.0 | 54.0                         | 60.0 | 80    |
|             | 2200                   | J16  | 16.0                              | 18.0 | 48.0                         | 54.0 | 80    |
|             |                        | J18  | 18.0                              | 20.0 | 54.0                         | 60.0 | 80    |

**Notes :**

(1) Correlated Color Temperature is derived from the CIE 1931 Chromaticity diagram.

(2) Seoul Semiconductor maintains a tolerance of  $\pm 7\%$  on Intensity and power measurements.

The luminous intensity  $I_V$  was measured at the peak of the spatial pattern which may not be aligned with the mechanical axis of the LED package.

(3) The lumen table is only for reference.

## Performance Characteristics

**Table 3. Characteristics,  $I_F=150\text{mA}$ ,  $T_J= 25^\circ\text{C}$ , RH30%**

| Parameter   | Symbol          | Value                 |      |      | Unit                      |
|---|-----------------|-----------------------|------|------|---------------------------|
|   |                 | Min.                  | Typ. | Max. |                           |
| Forward Current   | $I_F$           | -                     | 150  | 180  | mA                        |
| Forward Voltage   | $V_F$           | -                     | 3.2  | 3.5  | V                         |
| Luminous Intensity <sup>[1]</sup> (2,700K) <sup>[2]</sup> | $I_v$           | -                     | 18.2 | -    | cd                        |
| CRI <sup>[3]</sup>  | $R_a$           | 80                    | 83   | 90   |                           |
| Viewing Angle   | $2\theta_{1/2}$ | -                     | 120  | -    | Deg.                      |
| Storage Temperature                                       | $T_{stg}$       | - 40                  | -    | + 85 | $^\circ\text{C}$          |
| Thermal resistance (J to S) <sup>[4]</sup>                | $R\theta_{J-S}$ | -                     | 35   | -    | $^\circ\text{C}/\text{W}$ |
| ESD Sensitivity(HBM)                                      | -               | Class 2 JESD22-A114-E |      |      |                           |

**Table 4. Absolute Maximum Ratings**

| Parameter             | Symbol    | Value       | Unit             |
|-----------------------|-----------|-------------|------------------|
| Forward Current       | $I_F$     | 180         | mA               |
| Power Dissipation     | $P_D$     | 0.63        | W                |
| Junction Temperature  | $T_j$     | 125         | $^\circ\text{C}$ |
| Operating Temperature | $T_{opr}$ | -40 ~ + 85  | $^\circ\text{C}$ |
| Storage Temperature   | $T_{stg}$ | -40 ~ + 100 | $^\circ\text{C}$ |

**Notes :**

- (1) Seoul Semiconductor maintains a tolerance of  $\pm 7\%$  on Intensity and power measurements.
- (2) Correlated Color Temperature is derived from the CIE 1931 Chromaticity diagram.  
Color coordinate :  $\pm 0.005$ , CCT  $\pm 5\%$  tolerance.
- (3) Tolerance is  $\pm 2.0$  on CRI measurements.
- (4) Thermal resistance is junction to Solder.
- (5)  $I_{FP}$  conditions with pulse width  $\leq 10\text{ms}$  and duty cycle  $\leq 10\%$
- (6) The products are sensitive to static electricity and must be carefully taken when handling products

- **Calculated performance values are for reference only.**
- **All measurements were made under the standardized environment of Seoul Semiconductor.**

## Characteristics Graph

Fig 1. Color Spectrum,  $T_j = 25^\circ\text{C}$ ,  $I_F = 150\text{mA}$

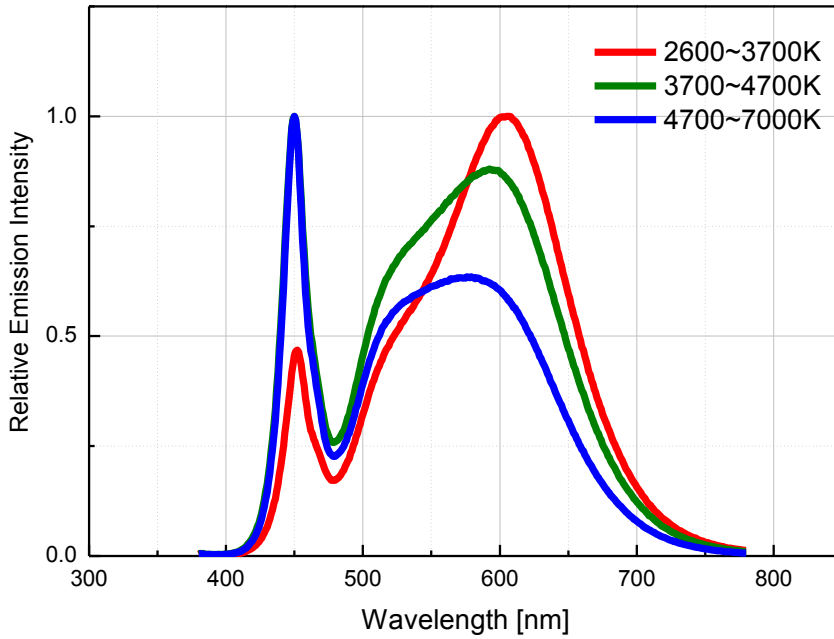
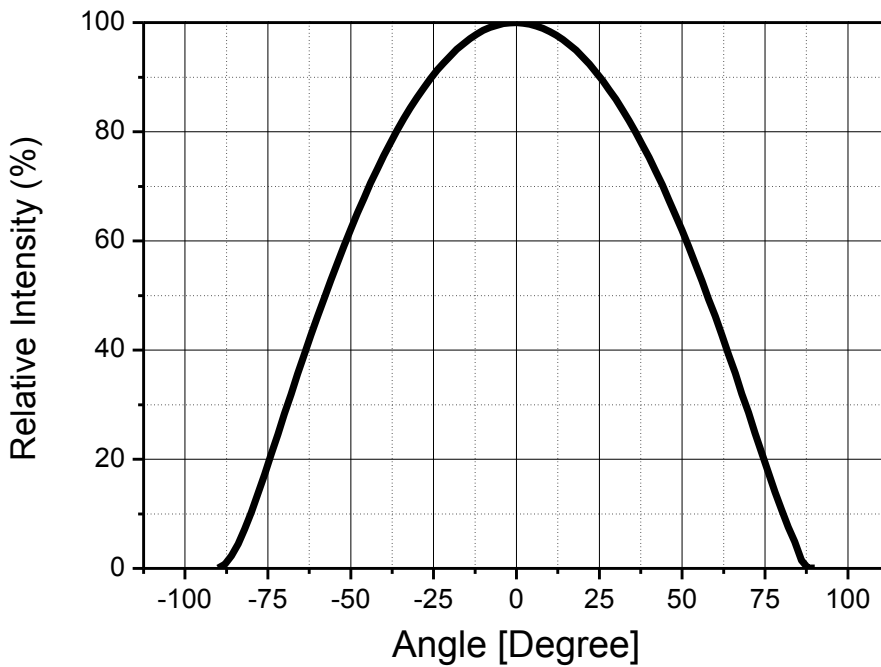

Fig 2. Radiant Pattern,  $T_j = 25^\circ\text{C}$ ,  $I_F = 150\text{mA}$



## Characteristics Graph

Fig 3. Forward Voltage vs. Forward Current,  $T_j = 25^\circ\text{C}$

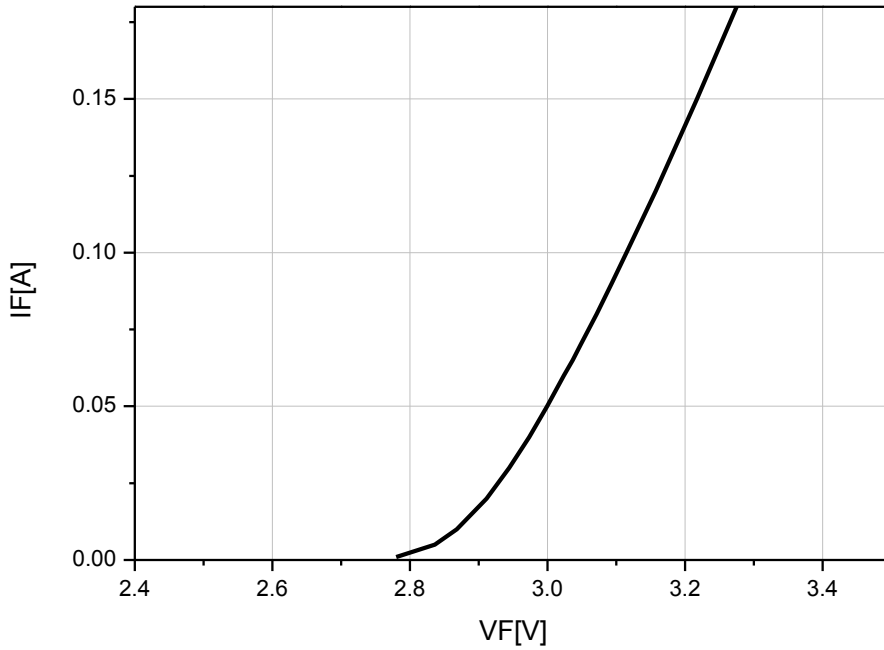
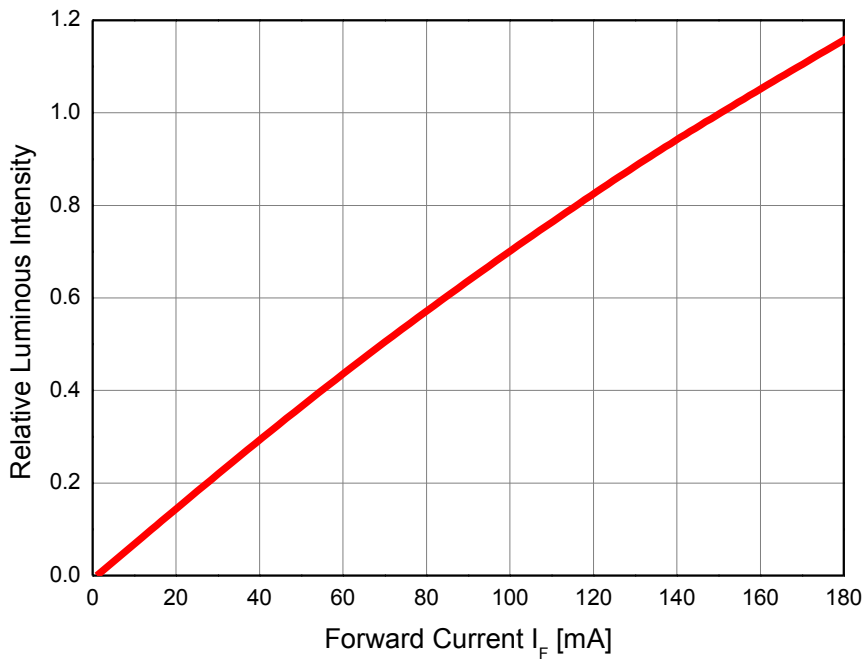
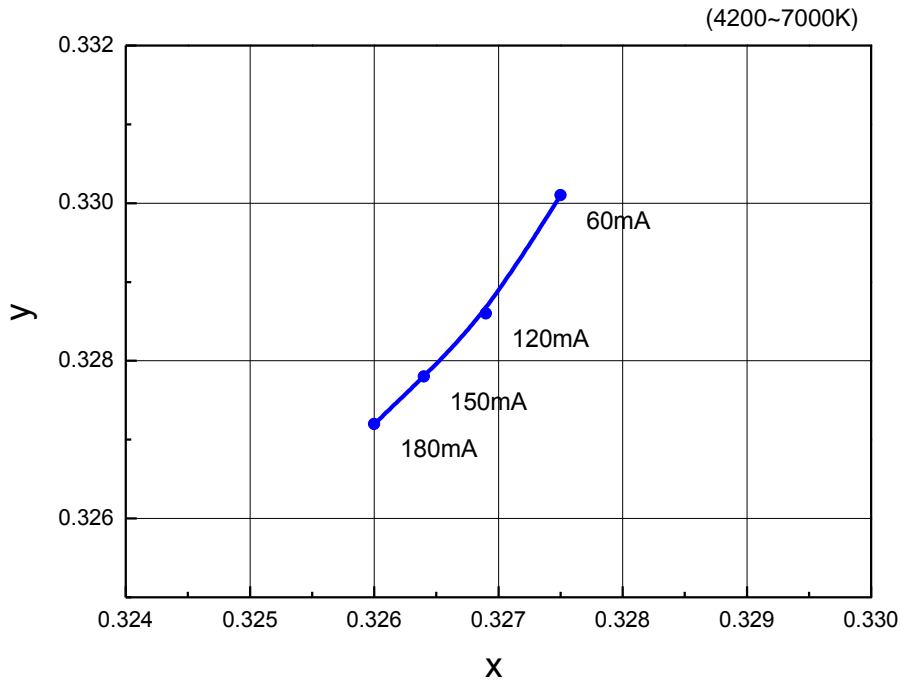
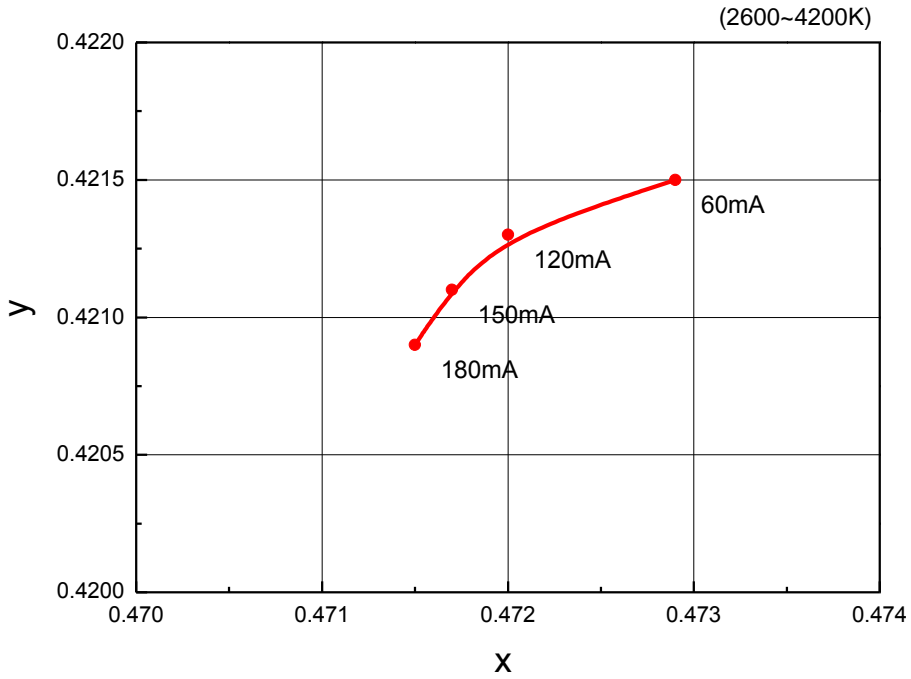

Fig 4. Forward Current vs. Relative Luminous Intensity,  $T_j = 25^\circ\text{C}$



## Characteristics Graph

**Fig 5. Forward Current vs. CIE X,Y Shift,  $T_j = 25^\circ\text{C}$** 

## Characteristics Graph

**Fig 6. Junction Temperature vs. Relative Luminous Intensity,  $I_F=150\text{mA}$**

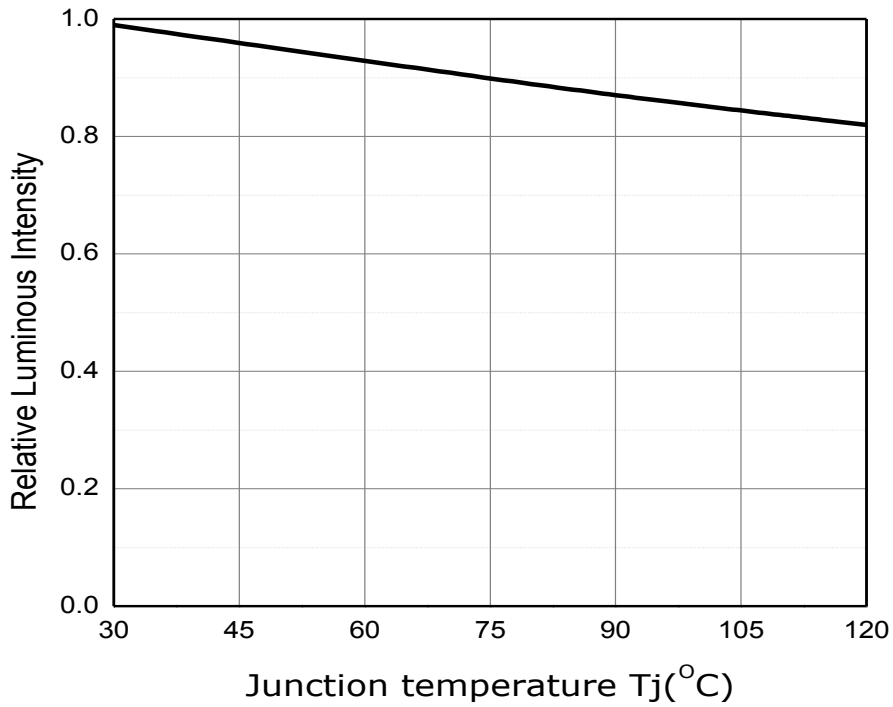

**Fig 7. Junction Temperature vs. Relative Forward Voltage,  $I_F=150\text{mA}$**

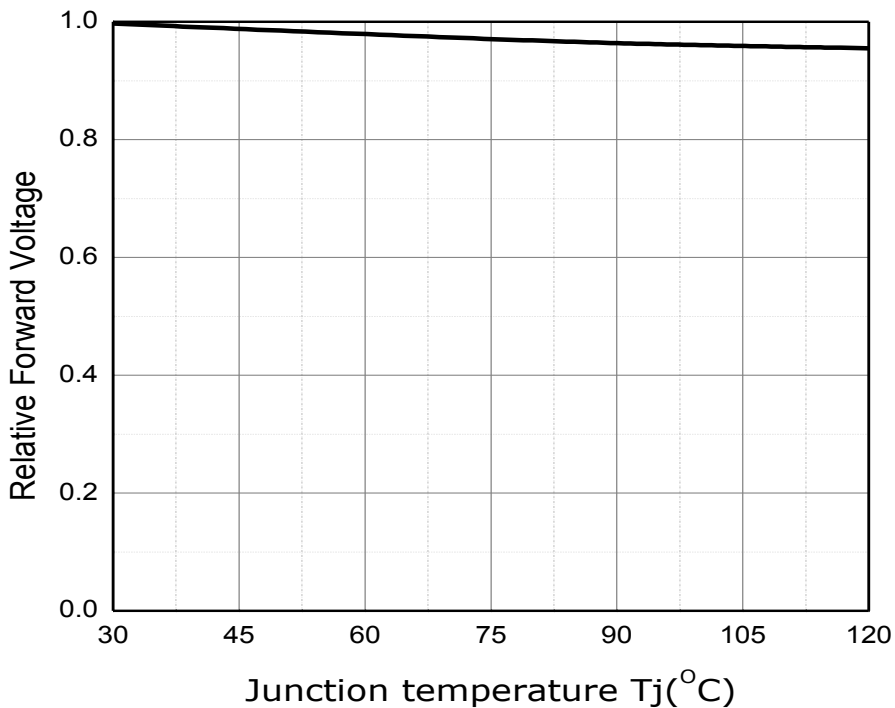



## Characteristics Graph

Fig 8. Chromaticity Coordinate vs. Junction Temperature,  $I_F=150\text{mA}$

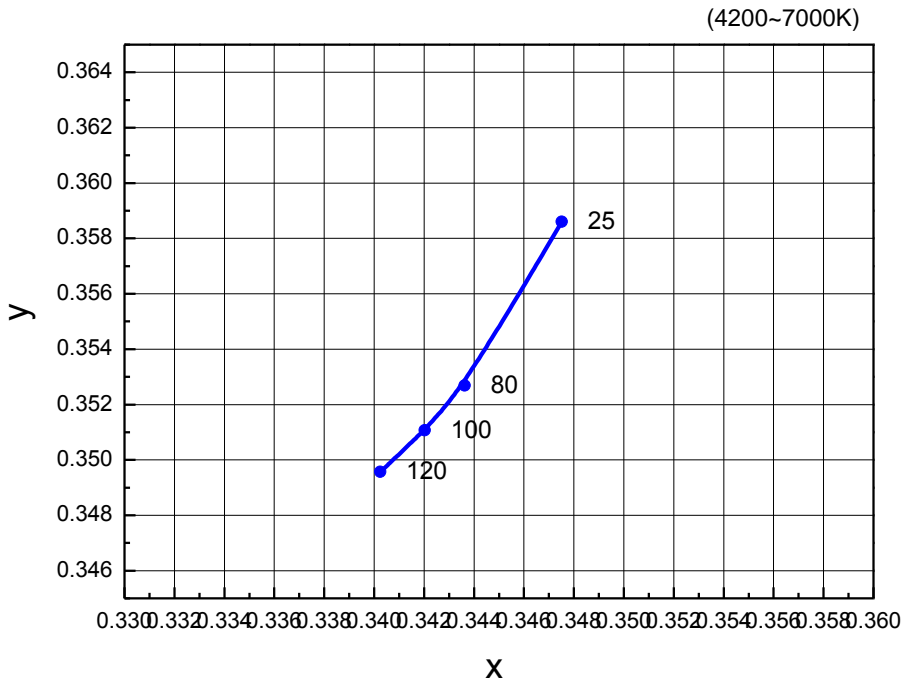
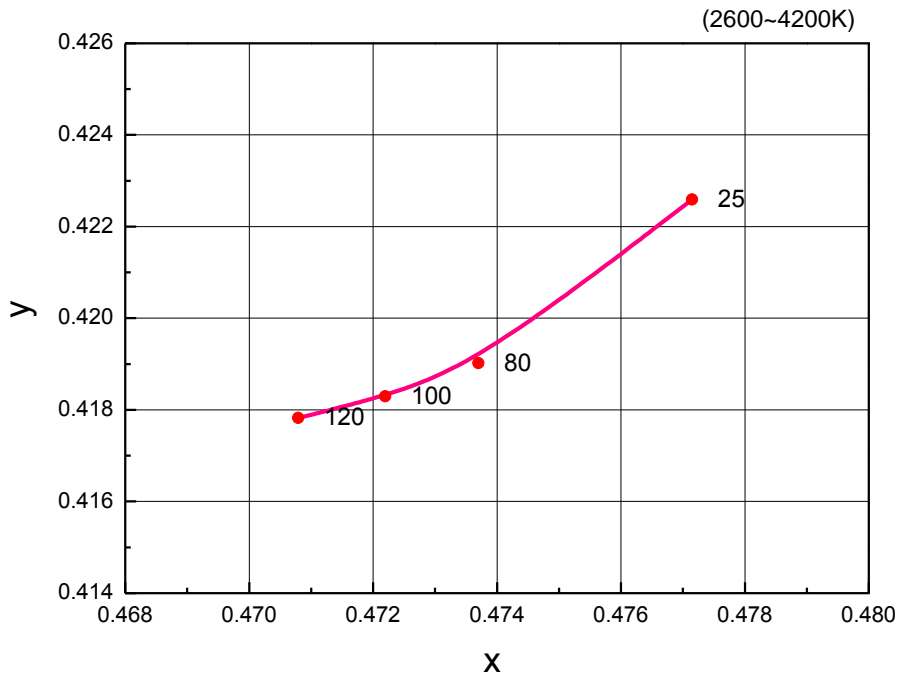

## Characteristics Graph

Fig 9. Ambient Temperature vs. Maximum Forward Current,  $T_{j\_max} = 125^{\circ}\text{C}$

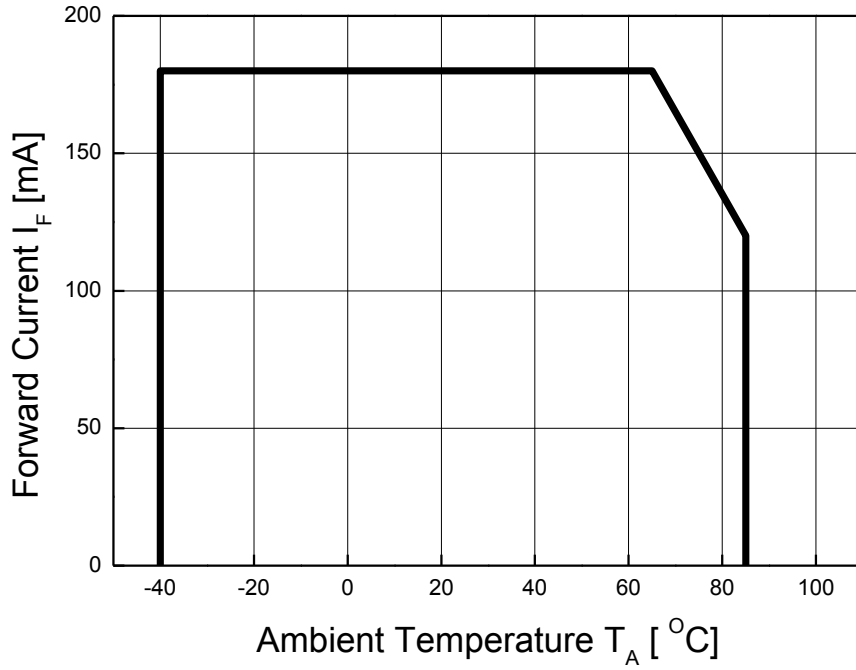

## Color Bin Structure

**Table 5. Bin Code description,  $T_j=25^\circ\text{C}$ ,  $I_F=150\text{mA}$** 

| Part Number | Luminous Intensity (cd) |      |      | Color Chromaticity Coordinate | Typical Forward Voltage (V) |      |      |
|-------------|-------------------------|------|------|-------------------------------|-----------------------------|------|------|
|             | Bin Code                | Min. | Max. |                               | Bin Code                    | Min. | Max. |
| STW8A12D    | J16                     | 16.0 | 18.0 | Refer to Page. 12             | Y3                          | 2.9  | 3.0  |
|             | J18                     | 18.0 | 20.0 |                               | Z1                          | 3.0  | 3.1  |
|             | K20                     | 20.0 | 22.0 |                               | Z2                          | 3.1  | 3.2  |
|             | K22                     | 22.0 | 24.0 |                               | Z3                          | 3.2  | 3.3  |
|             |                         |      |      |                               | A1                          | 3.3  | 3.4  |
|             |                         |      |      |                               | A2                          | 3.4  | 3.5  |

**Table 6. Intensity rank distribution**
 Available ranks

| CCT            | CIE | IV Rank |     |     |     |
|----------------|-----|---------|-----|-----|-----|
| 6,000 ~ 7,000K | A   | J16     | J18 | K20 | K22 |
| 5,300 ~ 6,000K | B   | J16     | J18 | K20 | K22 |
| 4,700 ~ 5,300K | C   | J16     | J18 | K20 | K22 |
| 4,200 ~ 4,700K | D   | J16     | J18 | K20 | K22 |
| 3,700 ~ 4,200K | E   | J16     | J18 | K20 | K22 |
| 3,200 ~ 3,700K | F   | J16     | J18 | K20 | K22 |
| 2,900 ~ 3,200K | G   | J16     | J18 | K20 | K22 |
| 2,600 ~ 2,900K | H   | J16     | J18 | K20 | K22 |
| 2,300 ~ 2,600K | J   | J16     | J18 | K20 | K22 |
| 2,100 ~ 2,300K | K   | J16     | J18 | K20 | K22 |

**\*Notes :**

(1) Calculated performance values are for reference only.

- All measurements were made under the standardized environment of Seoul Semiconductor.  
In order to ensure availability, single color rank will not be orderable.

## Color Bin Structure

CIE Chromaticity Diagram  $T_j=25^\circ\text{C}$ ,  $I_f=150\text{mA}$

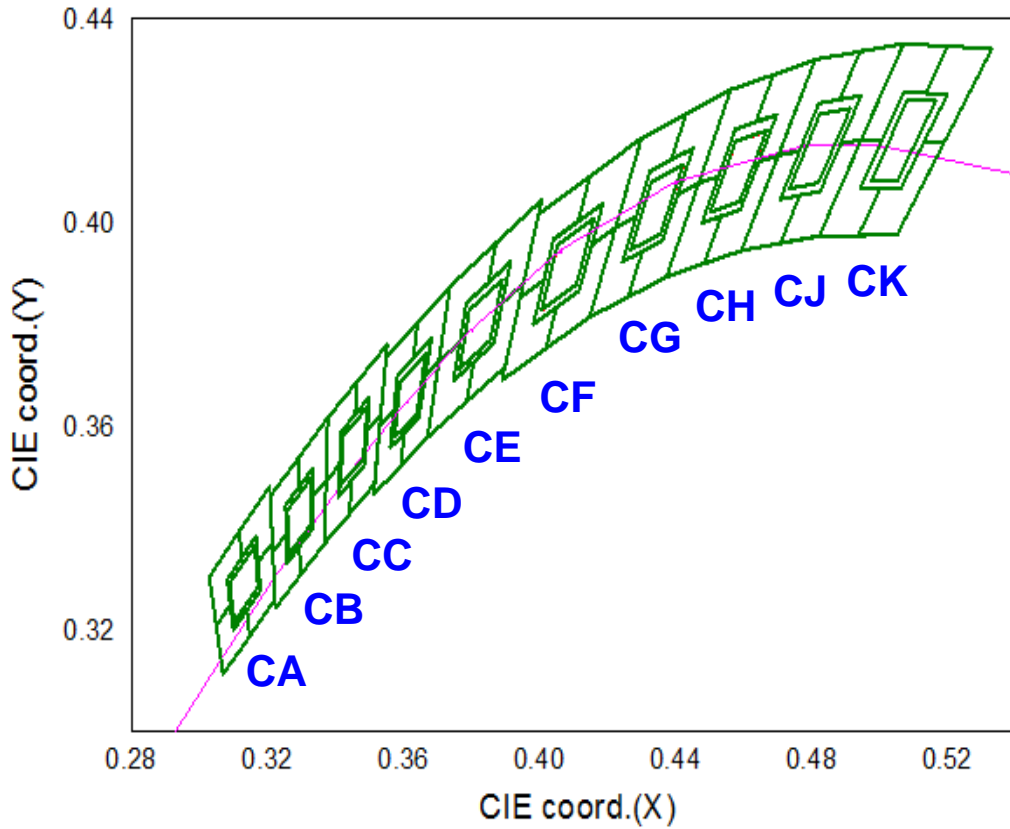

**\*Notes :**

- Energy Star binning applied to all 2600~7000K.
- Measurement Uncertainty of the Color Coordinates :  $\pm 0.005$

## Color Bin Structure

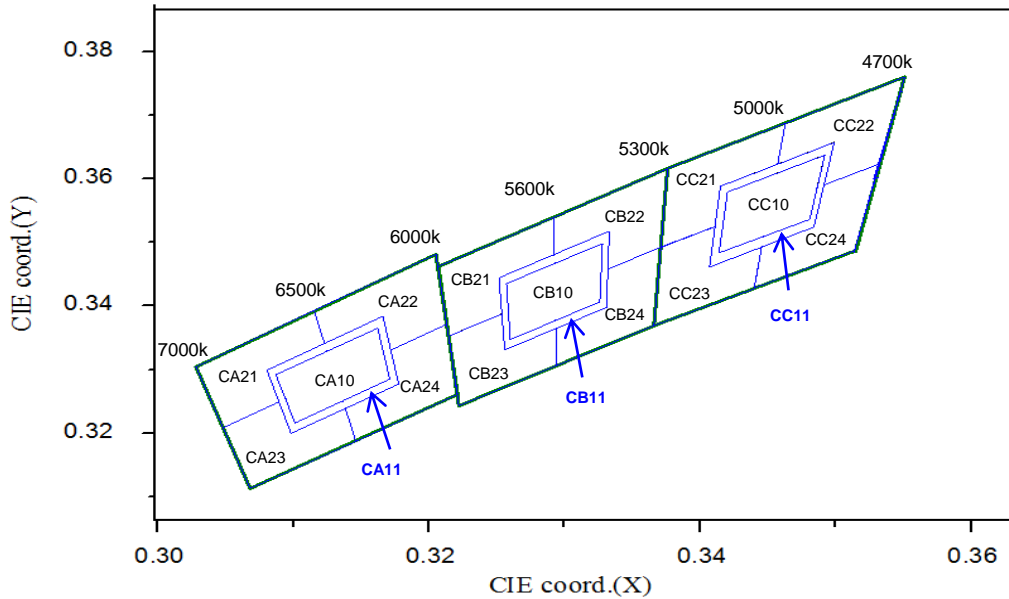
**CIE Chromaticity Diagram  $T_j=25^\circ\text{C}$ ,  $I_f=150\text{mA}$** 

| CA10   |        | CA11   |        | CA21   |        | CA22   |        | CA23   |        |
|--------|--------|--------|--------|--------|--------|--------|--------|--------|--------|
| CIE X  | CIE Y  | CIE X  | CIE Y  | CIE X  | CIE Y  | CIE X  | CIE Y  | CIE X  | CIE Y  |
| 0.3087 | 0.3292 | 0.3080 | 0.3299 | 0.3028 | 0.3304 | 0.3115 | 0.3393 | 0.3048 | 0.3209 |
| 0.3162 | 0.3365 | 0.3166 | 0.3384 | 0.3115 | 0.3393 | 0.3205 | 0.3481 | 0.3131 | 0.3290 |
| 0.3171 | 0.3285 | 0.3178 | 0.3277 | 0.3131 | 0.3290 | 0.3213 | 0.3371 | 0.3146 | 0.3187 |
| 0.3101 | 0.3216 | 0.3098 | 0.3200 | 0.3048 | 0.3209 | 0.3131 | 0.3290 | 0.3068 | 0.3113 |
| CA24   |        | CB10   |        | CB11   |        | CB21   |        | CB22   |        |
| CIE X  | CIE Y  | CIE X  | CIE Y  | CIE X  | CIE Y  | CIE X  | CIE Y  | CIE X  | CIE Y  |
| 0.3131 | 0.3290 | 0.3257 | 0.3435 | 0.3252 | 0.3444 | 0.3207 | 0.3462 | 0.3292 | 0.3539 |
| 0.3213 | 0.3371 | 0.3328 | 0.3498 | 0.3333 | 0.3518 | 0.3292 | 0.3539 | 0.3376 | 0.3616 |
| 0.3221 | 0.3261 | 0.3326 | 0.3406 | 0.3331 | 0.3398 | 0.3293 | 0.3423 | 0.3371 | 0.3493 |
| 0.3146 | 0.3187 | 0.3260 | 0.3347 | 0.3256 | 0.3331 | 0.3215 | 0.3353 | 0.3293 | 0.3423 |
| CB23   |        | CB24   |        | CC10   |        | CC11   |        | CC21   |        |
| CIE X  | CIE Y  | CIE X  | CIE Y  | CIE X  | CIE Y  | CIE X  | CIE Y  | CIE X  | CIE Y  |
| 0.3215 | 0.3353 | 0.3293 | 0.3423 | 0.3420 | 0.3579 | 0.3415 | 0.3588 | 0.3376 | 0.3616 |
| 0.3293 | 0.3423 | 0.3371 | 0.3493 | 0.3492 | 0.3637 | 0.3499 | 0.3657 | 0.3463 | 0.3687 |
| 0.3294 | 0.3306 | 0.3366 | 0.3369 | 0.3481 | 0.3536 | 0.3484 | 0.3524 | 0.3452 | 0.3557 |
| 0.3222 | 0.3243 | 0.3294 | 0.3306 | 0.3414 | 0.3483 | 0.3407 | 0.3461 | 0.3371 | 0.3493 |
| CC22   |        | CC23   |        | CC24   |        |        |        |        |        |
| CIE X  | CIE Y  | CIE X  | CIE Y  | CIE X  | CIE Y  |        |        |        |        |
| 0.3463 | 0.3687 | 0.3371 | 0.3492 | 0.3451 | 0.3557 |        |        |        |        |
| 0.3551 | 0.3760 | 0.3451 | 0.3557 | 0.3532 | 0.3623 |        |        |        |        |
| 0.3532 | 0.3623 | 0.3440 | 0.3427 | 0.3514 | 0.3487 |        |        |        |        |
| 0.3451 | 0.3557 | 0.3366 | 0.3369 | 0.3440 | 0.3428 |        |        |        |        |

## Color Bin Structure

**CIE Chromaticity Diagram  $T_j=25^\circ\text{C}$ ,  $I_f=150\text{mA}$**

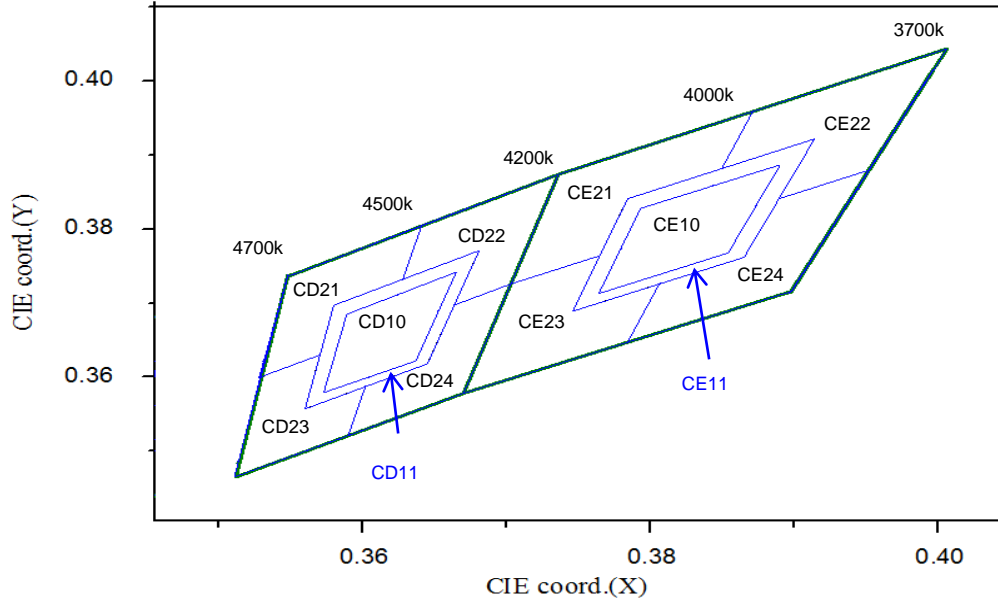

| CD10   |        | CD11   |        | CD21   |        | CD22   |        | CD23   |        |
|--------|--------|--------|--------|--------|--------|--------|--------|--------|--------|
| CIE X  | CIE Y  | CIE X  | CIE Y  | CIE X  | CIE Y  | CIE X  | CIE Y  | CIE X  | CIE Y  |
| 0.3589 | 0.3685 | 0.3560 | 0.3557 | 0.3528 | 0.3599 | 0.3641 | 0.3805 | 0.3530 | 0.3601 |
| 0.3665 | 0.3742 | 0.3580 | 0.3697 | 0.3548 | 0.3736 | 0.3736 | 0.3874 | 0.3616 | 0.3663 |
| 0.3637 | 0.3622 | 0.3681 | 0.3771 | 0.3641 | 0.3805 | 0.3703 | 0.3726 | 0.3590 | 0.3521 |
| 0.3573 | 0.3579 | 0.3645 | 0.3618 | 0.3616 | 0.3663 | 0.3616 | 0.3663 | 0.3511 | 0.3465 |
| CD24   |        | CE10   |        | CE11   |        | CE21   |        | CE22   |        |
| CIE X  | CIE Y  | CIE X  | CIE Y  | CIE X  | CIE Y  | CIE X  | CIE Y  | CIE X  | CIE Y  |
| 0.3616 | 0.3663 | 0.3764 | 0.3713 | 0.3746 | 0.3689 | 0.3703 | 0.3726 | 0.3828 | 0.3803 |
| 0.3703 | 0.3726 | 0.3793 | 0.3828 | 0.3784 | 0.3841 | 0.3736 | 0.3874 | 0.3871 | 0.3959 |
| 0.3670 | 0.3578 | 0.3890 | 0.3887 | 0.3914 | 0.3922 | 0.3871 | 0.3959 | 0.4006 | 0.4044 |
| 0.3590 | 0.3521 | 0.3854 | 0.3768 | 0.3865 | 0.3762 | 0.3828 | 0.3803 | 0.3952 | 0.3880 |
| CE23   |        | CE24   |        |        |        |        |        |        |        |
| CIE X  | CIE Y  | CIE X  | CIE Y  |        |        |        |        |        |        |
| 0.3670 | 0.3578 | 0.3784 | 0.3647 |        |        |        |        |        |        |
| 0.3703 | 0.3726 | 0.3828 | 0.3803 |        |        |        |        |        |        |
| 0.3828 | 0.3803 | 0.3952 | 0.3880 |        |        |        |        |        |        |
| 0.3784 | 0.3647 | 0.3898 | 0.3716 |        |        |        |        |        |        |

## Color Bin Structure

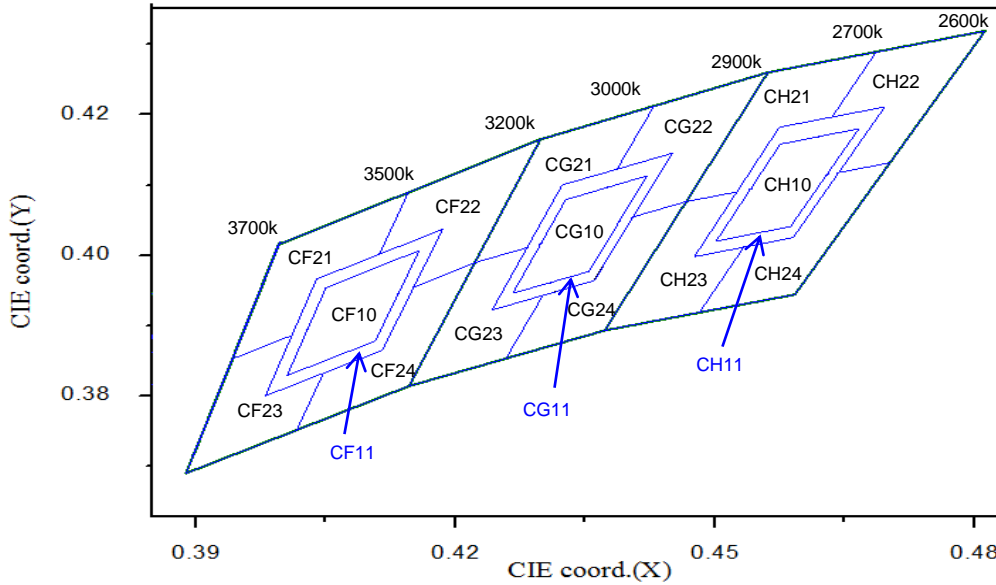
**CIE Chromaticity Diagram  $T_j=25^\circ\text{C}$ ,  $I_f=150\text{mA}$** 

| CF10   |        | CF11   |        | CF21   |        | CF22   |        | CF23   |        |
|--------|--------|--------|--------|--------|--------|--------|--------|--------|--------|
| CIE X  | CIE Y  | CIE X  | CIE Y  | CIE X  | CIE Y  | CIE X  | CIE Y  | CIE X  | CIE Y  |
| 0.4006 | 0.3829 | 0.3981 | 0.3800 | 0.3996 | 0.4015 | 0.4146 | 0.4089 | 0.3943 | 0.3853 |
| 0.4051 | 0.3954 | 0.4040 | 0.3966 | 0.4146 | 0.4089 | 0.4299 | 0.4165 | 0.4082 | 0.3920 |
| 0.4159 | 0.4007 | 0.4186 | 0.4037 | 0.4082 | 0.3920 | 0.4223 | 0.3990 | 0.4017 | 0.3751 |
| 0.4108 | 0.3878 | 0.4116 | 0.3865 | 0.3943 | 0.3853 | 0.4082 | 0.3920 | 0.3889 | 0.3690 |
| CF24   |        | CG10   |        | CG11   |        | CG21   |        | CG22   |        |
| CIE X  | CIE Y  | CIE X  | CIE Y  | CIE X  | CIE Y  | CIE X  | CIE Y  | CIE X  | CIE Y  |
| 0.4082 | 0.3920 | 0.4267 | 0.3946 | 0.4243 | 0.3922 | 0.4299 | 0.4165 | 0.4430 | 0.4212 |
| 0.4223 | 0.3990 | 0.4328 | 0.4079 | 0.4324 | 0.4100 | 0.4430 | 0.4212 | 0.4562 | 0.4260 |
| 0.4147 | 0.3814 | 0.4422 | 0.4113 | 0.4451 | 0.4145 | 0.4345 | 0.4033 | 0.4468 | 0.4077 |
| 0.4017 | 0.3751 | 0.4355 | 0.3977 | 0.4361 | 0.3964 | 0.4223 | 0.3990 | 0.4345 | 0.4033 |
| CG23   |        | CG24   |        | CH10   |        | CH11   |        | CH21   |        |
| CIE X  | CIE Y  | CIE X  | CIE Y  | CIE X  | CIE Y  | CIE X  | CIE Y  | CIE X  | CIE Y  |
| 0.4223 | 0.3990 | 0.4345 | 0.4033 | 0.4502 | 0.4020 | 0.4477 | 0.3998 | 0.4562 | 0.4260 |
| 0.4345 | 0.4033 | 0.4468 | 0.4077 | 0.4576 | 0.4158 | 0.4575 | 0.4182 | 0.4687 | 0.4289 |
| 0.4259 | 0.3853 | 0.4373 | 0.3893 | 0.4667 | 0.4180 | 0.4697 | 0.4211 | 0.4585 | 0.4104 |
| 0.4147 | 0.3814 | 0.4259 | 0.3853 | 0.4588 | 0.4041 | 0.4591 | 0.4025 | 0.4468 | 0.4077 |
| CH22   |        | CH23   |        | CH24   |        |        |        |        |        |
| CIE X  | CIE Y  | CIE X  | CIE Y  | CIE X  | CIE Y  |        |        |        |        |
| 0.4687 | 0.4289 | 0.4468 | 0.4077 | 0.4585 | 0.4104 |        |        |        |        |
| 0.4813 | 0.4319 | 0.4585 | 0.4104 | 0.4703 | 0.4132 |        |        |        |        |
| 0.4703 | 0.4132 | 0.4483 | 0.3919 | 0.4593 | 0.3944 |        |        |        |        |
| 0.4585 | 0.4104 | 0.4373 | 0.3893 | 0.4483 | 0.3919 |        |        |        |        |

## Color Bin Structure

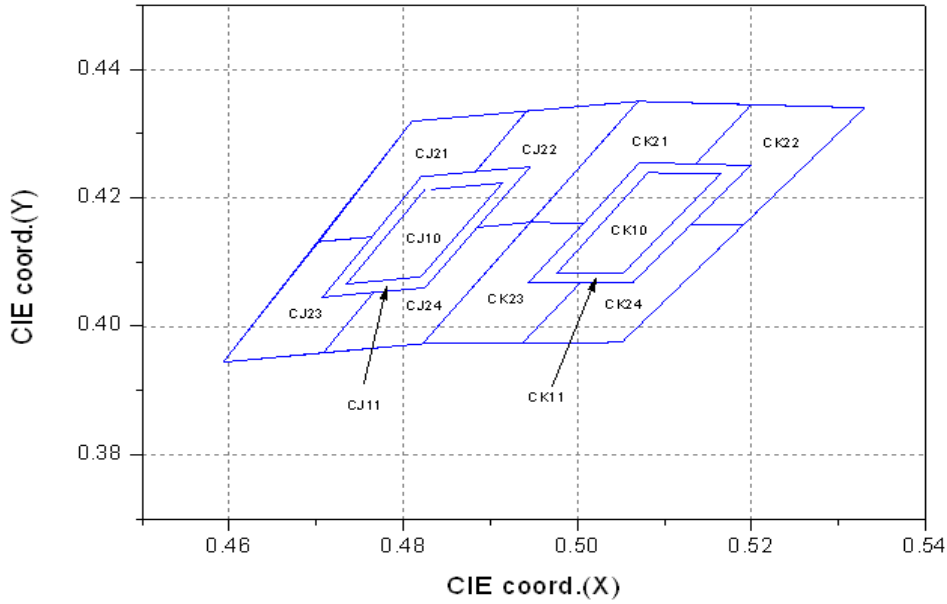
**CIE Chromaticity Diagram  $T_f=25^\circ\text{C}$ ,  $I_f=150\text{mA}$** 

| CJ10   |        | CJ11   |        | CJ21   |        | CJ22   |        | CJ23   |        |
|--------|--------|--------|--------|--------|--------|--------|--------|--------|--------|
| CIE X  | CIE Y  | CIE X  | CIE Y  | CIE X  | CIE Y  | CIE X  | CIE Y  | CIE X  | CIE Y  |
| 0.4825 | 0.4213 | 0.4821 | 0.4233 | 0.4810 | 0.4319 | 0.4942 | 0.4335 | 0.4703 | 0.4132 |
| 0.4735 | 0.4066 | 0.4707 | 0.4045 | 0.4703 | 0.4132 | 0.4824 | 0.4147 | 0.4593 | 0.3944 |
| 0.4820 | 0.4077 | 0.4825 | 0.4060 | 0.4824 | 0.4147 | 0.4946 | 0.4162 | 0.4708 | 0.3959 |
| 0.4914 | 0.4223 | 0.4946 | 0.4248 | 0.4942 | 0.4335 | 0.5070 | 0.4350 | 0.4824 | 0.4147 |
| CJ24   |        | CK10   |        | CK11   |        | CK21   |        | CK22   |        |
| CIE X  | CIE Y  | CIE X  | CIE Y  | CIE X  | CIE Y  | CIE X  | CIE Y  | CIE X  | CIE Y  |
| 0.4824 | 0.4147 | 0.5081 | 0.4239 | 0.5071 | 0.4254 | 0.5070 | 0.4350 | 0.5200 | 0.4345 |
| 0.4708 | 0.3959 | 0.4976 | 0.4082 | 0.4943 | 0.4067 | 0.4946 | 0.4162 | 0.5066 | 0.4160 |
| 0.4822 | 0.3973 | 0.5052 | 0.4082 | 0.5043 | 0.4067 | 0.5066 | 0.4160 | 0.5191 | 0.4158 |
| 0.4946 | 0.4162 | 0.5165 | 0.4238 | 0.5199 | 0.4250 | 0.5200 | 0.4345 | 0.5330 | 0.4340 |
| CK23   |        | CK24   |        |        |        |        |        |        |        |
| CIE X  | CIE Y  | CIE X  | CIE Y  |        |        |        |        |        |        |
| 0.4946 | 0.4162 | 0.5066 | 0.4160 |        |        |        |        |        |        |
| 0.4822 | 0.3973 | 0.4937 | 0.3974 |        |        |        |        |        |        |
| 0.4937 | 0.3974 | 0.5051 | 0.3975 |        |        |        |        |        |        |
| 0.5066 | 0.4160 | 0.5191 | 0.4158 |        |        |        |        |        |        |

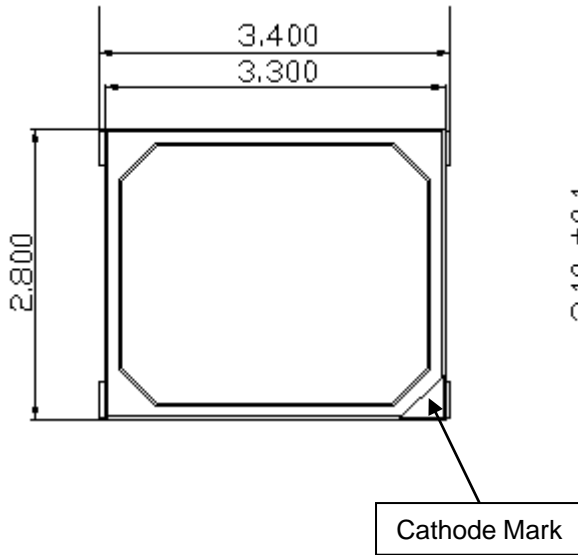
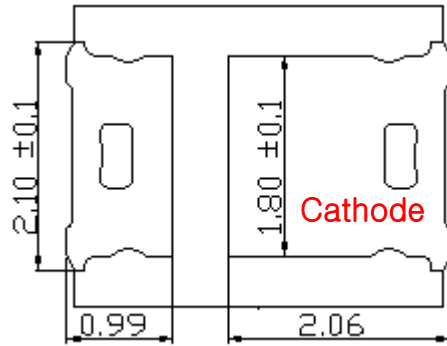
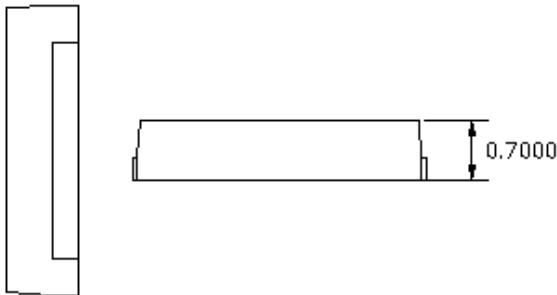
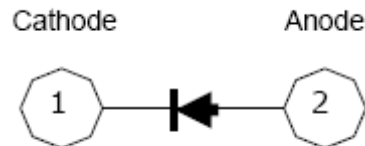

## Mechanical Dimensions

**Top View**

**Bottom View**

**Side View**

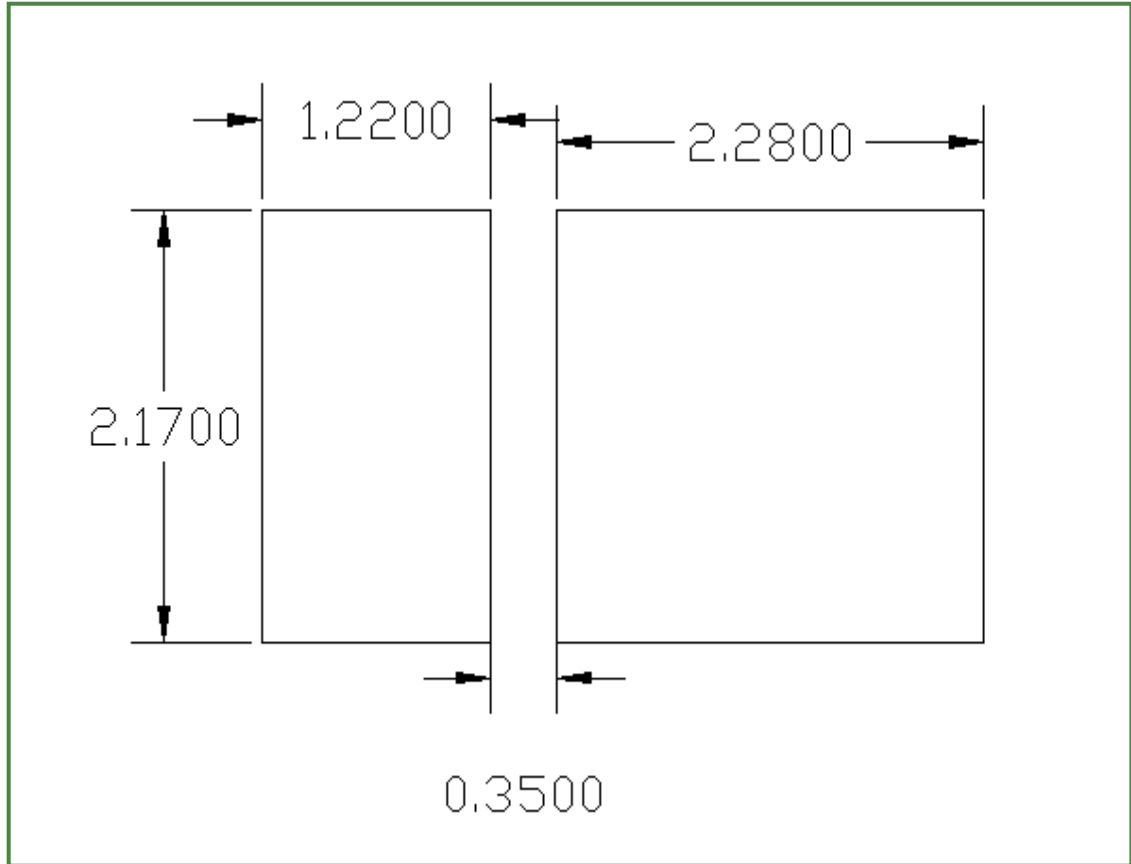
**Circuit**

**Notes :**

- (1) All dimensions are in millimeters.
- (2) Scale : none
- (3) Undefined tolerance is  $\pm 0.2\text{mm}$

## Recommended Solder Pad

**Notes :**

- (1) All dimensions are in millimeters.
- (2) Scale : none
- (3) This drawing without tolerances are for reference only
- (4) Undefined tolerance is  $\pm 0.1\text{mm}$
- (5) The appearance and specifications of the product may be changed for improvement without notice.

## Reflow Soldering Characteristics

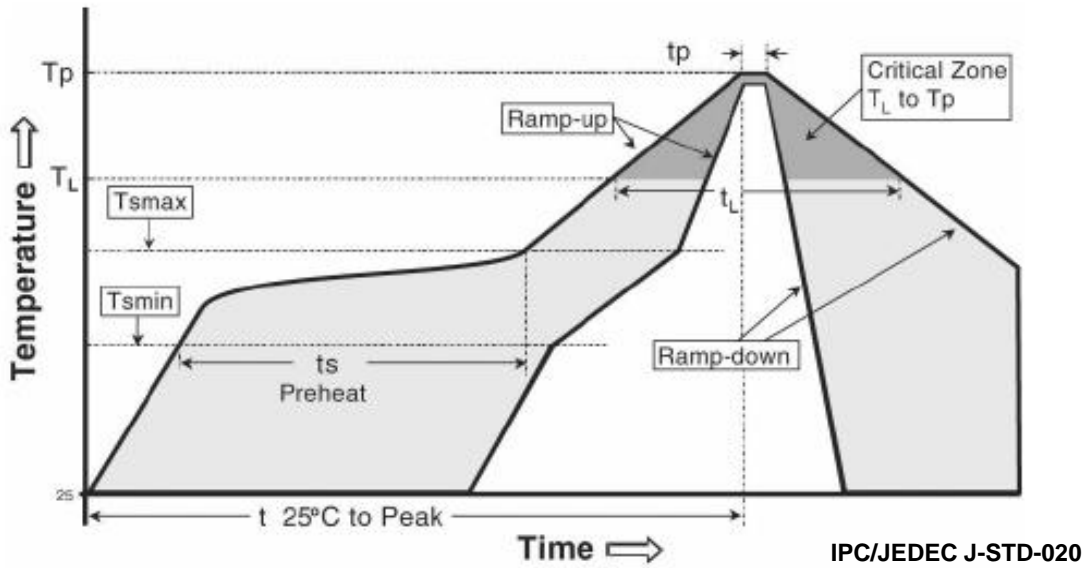

| Profile Feature   | Sn-Pb Eutectic Assembly            | Pb-Free Assembly                   |
|---|------------------------------------|------------------------------------|
| Average ramp-up rate (T <sub>s_max</sub> to T <sub>p</sub> )  | 3° C/second max.                   | 3° C/second max.                   |
| Preheat<br>- Temperature Min (T <sub>s_min</sub> )<br>- Temperature Max (T <sub>s_max</sub> )<br>- Time (T <sub>s_min</sub> to T <sub>s_max</sub> ) (t <sub>s</sub> ) | 100 °C<br>150 °C<br>60-120 seconds | 150 °C<br>200 °C<br>60-180 seconds |
| Time maintained above:<br>- Temperature (T <sub>L</sub> )<br>- Time (t <sub>L</sub> )   | 183 °C<br>60-150 seconds           | 217 °C<br>60-150 seconds           |
| Peak Temperature (T <sub>p</sub> )  | 215 °C                             | 260 °C                             |
| Time within 5°C of actual Peak Temperature (t <sub>p</sub> ) <sup>2</sup>   | 10-30 seconds                      | 20-40 seconds                      |
| Ramp-down Rate  | 6 °C/second max.                   | 6 °C/second max.                   |
| Time 25°C to Peak Temperature   | 6 minutes max.                     | 8 minutes max.                     |

### Caution :

- (1) Reflow soldering is recommended not to be done more than two times  
In the case of more than 24 hours passed soldering after first, LEDs will be damaged.
- (2) Repairs should not be done after the LEDs have been soldered  
When repair is unavoidable, suitable tools must be used.
- (3) Die slug is to be soldered.
- (4) When soldering, do not put stress on the LEDs during heating.
- (5) After soldering, do not warp the circuit board.

## Emitter Tape & Reel Packaging

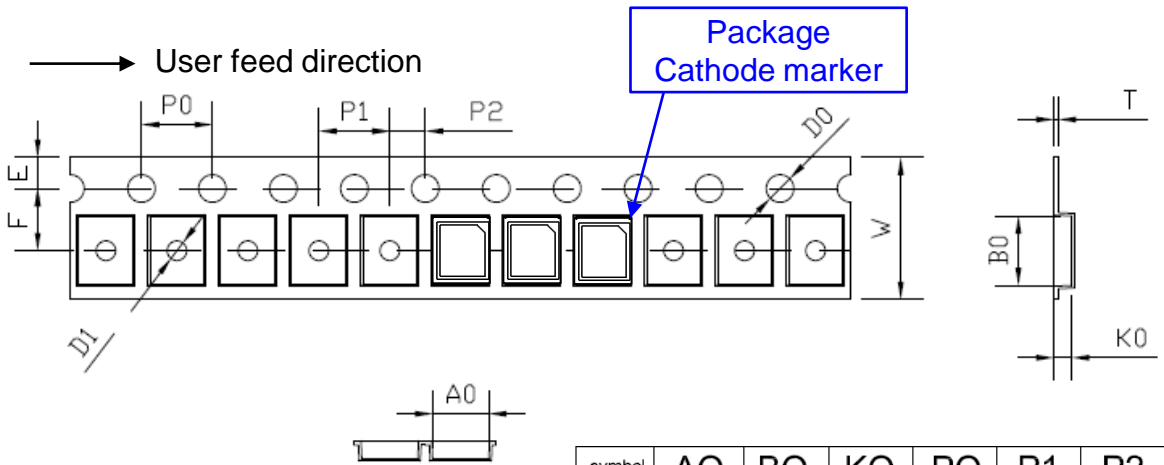

|        |           |           |           |          |          |           |
|--------|-----------|-----------|-----------|----------|----------|-----------|
| symbol | AO        | BO        | KO        | PO       | P1       | P2        |
| Spec   | 3.0±0.10  | 3.75±0.15 | 1.05±0.15 | 4.0±0.10 | 4.0±0.10 | 2.0±0.10  |
| symbol | W         | T         | E         | F        | DO       | D1        |
| Spec   | 8.00±0.10 | 0.20±0.05 | 1.75±0.10 | 3.5±0.10 | 1.5±0.05 | 1.10±0.10 |

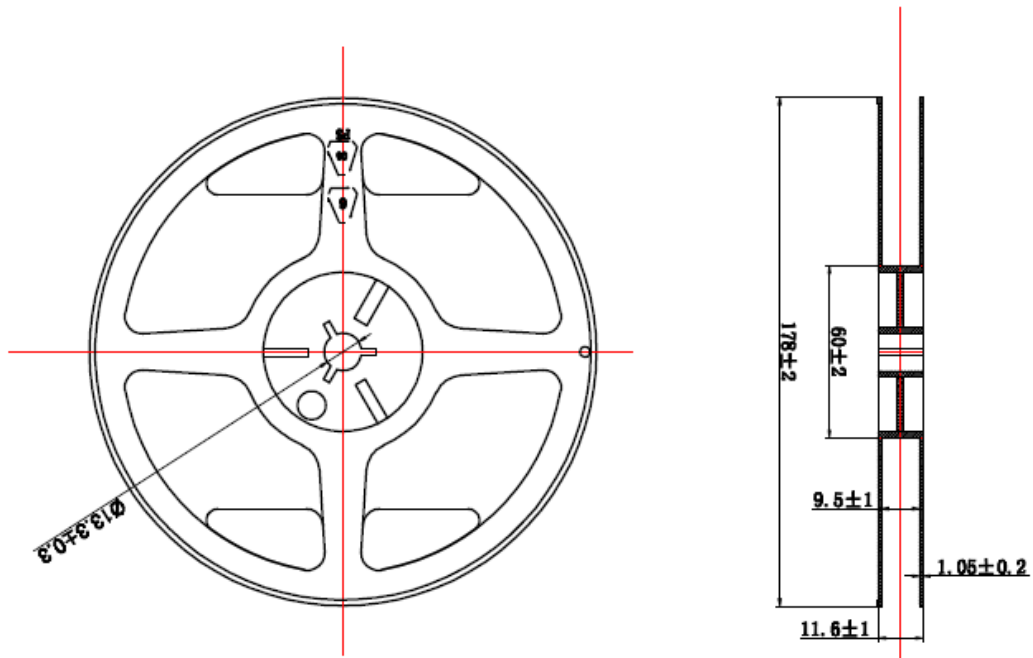

### Notes :

- (1) Quantity : Max 4,000pcs/Reel
- (2) Cumulative Tolerance : Cumulative Tolerance/10 pitches to be  $\pm 0.2\text{mm}$
- (3) Adhesion Strength of Cover Tape  
Adhesion strength to be 0.1-0.7N when the cover tape is turned off from the carrier tape at the angle of  $10^\circ$  to the carrier tape.
- (4) Package : P/N, Manufacturing data Code No. and Quantity to be indicated on a damp proof Package.

## Emitter Tape & Reel Packaging

### Reel

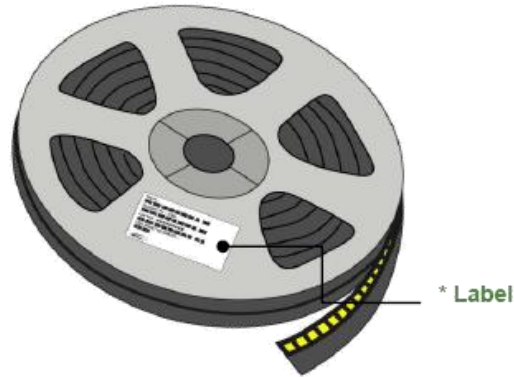

### Aluminum Bag

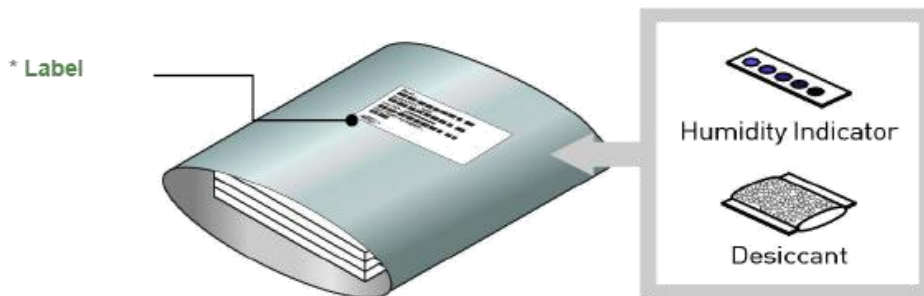

### Outer Box

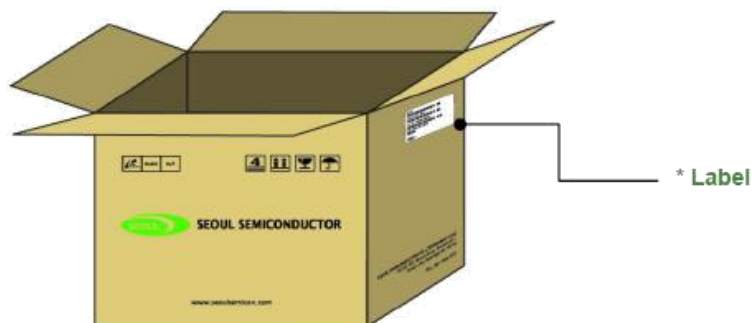

## Product Nomenclature

**Table 7. Part Numbering System : X<sub>1</sub>X<sub>2</sub>X<sub>3</sub>X<sub>4</sub>X<sub>5</sub>X<sub>6</sub>X<sub>7</sub>X<sub>8</sub>**

| Part Number Code              | Description         | Part Number | Value    |
|-------------------------------|---------------------|-------------|----------|
| X <sub>1</sub>                | Company             | S           |          |
| X <sub>2</sub>                | Top View LED series | T           |          |
| X <sub>3</sub>                | Color Specification | W8          | CRI 80   |
| X <sub>4</sub>                | Package series      | A           | A series |
| X <sub>5</sub> X <sub>6</sub> | Characteristic code | 12          |          |
| X <sub>7</sub>                | Version             | D           |          |

**Table 8. Lot Numbering System : Y<sub>1</sub>Y<sub>2</sub>Y<sub>3</sub>Y<sub>4</sub>Y<sub>5</sub>Y<sub>6</sub>Y<sub>7</sub>Y<sub>8</sub>Y<sub>9</sub>Y<sub>10</sub>–Y<sub>11</sub>Y<sub>12</sub>Y<sub>13</sub>Y<sub>14</sub>Y<sub>15</sub>Y<sub>16</sub>Y<sub>17</sub>**

| Lot Number Code   | Description         | Lot Number | Value |
|---|---------------------|------------|-------|
| Y <sub>1</sub> Y <sub>2</sub>   | Year                |            |       |
| Y <sub>3</sub>  | Month               |            |       |
| Y <sub>4</sub> Y <sub>5</sub>   | Day                 |            |       |
| Y <sub>6</sub>  | Top View LED series |            |       |
| Y <sub>7</sub> Y <sub>8</sub> Y <sub>9</sub> Y <sub>10</sub>  | Mass order          |            |       |
| Y <sub>11</sub> Y <sub>12</sub> Y <sub>13</sub> Y <sub>14</sub> Y <sub>15</sub> Y <sub>16</sub> Y <sub>17</sub> | Internal Number     |            |       |

## Handling of Silicone Resin for LEDs

(1) During processing, mechanical stress on the surface should be minimized as much as possible. Sharp objects of all types should not be used to pierce the sealing compound.



(2) In general, LEDs should only be handled from the side. By the way, this also applies to LEDs without a silicone sealant, since the surface can also become scratched.

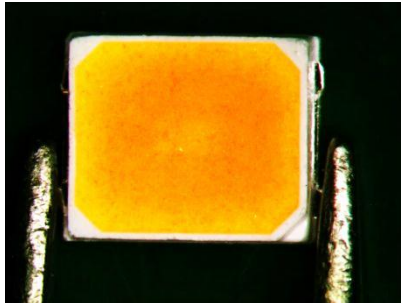

(3) When populating boards in SMT production, there are basically no restrictions regarding the form of the pick and place nozzle, except that mechanical pressure on the surface of the resin must be prevented. This is assured by choosing a pick and place nozzle which is larger than the LED's reflector area.

(4) Silicone differs from materials conventionally used for the manufacturing of LEDs. These conditions must be considered during the handling of such devices. Compared to standard encapsulants, silicone is generally softer, and the surface is more likely to attract dust.

As mentioned previously, the increased sensitivity to dust requires special care during processing. In cases where a minimal level of dirt and dust particles cannot be guaranteed, a suitable cleaning solution must be applied to the surface after the soldering of components.

(5) SSC suggests using isopropyl alcohol for cleaning. In case other solvents are used, it must be assured that these solvents do not dissolve the package or resin.

Ultrasonic cleaning is not recommended. Ultrasonic cleaning may cause damage to the LED.

(6) Please do not mold this product into another resin (epoxy, urethane, etc) and do not handle this product with acid or sulfur material in sealed space.

## Precaution for Use

(1) Storage

To avoid the moisture penetration, we recommend store in a dry box with a desiccant.

The recommended storage temperature range is 5°C to 30°C and a maximum humidity of RH50%.

(2) Use Precaution after Opening the Packaging

Use proper SMT techniques when the LED is to be soldered dipped as separation of the lens may affect the light output efficiency.

Pay attention to the following:

a. Recommend conditions after opening the package

- Sealing

- Temperature : 5 ~ 30°C Humidity : less than RH60%

b. If the package has been opened more than 4 week(MSL\_2a) or the color of the desiccant changes, components should be dried for 10-24hr at 65±5°C

(3) Do not apply mechanical force or excess vibration during the cooling process to normal temperature after soldering.

(4) Do not rapidly cool device after soldering.

(5) Components should not be mounted on warped (non coplanar) portion of PCB.

(6) Radioactive exposure is not considered for the products listed here in.

(7) Gallium arsenide is used in some of the products listed in this publication.

These products are dangerous if they are burned or shredded in the process of disposal.

It is also dangerous to drink the liquid or inhale the gas generated by such products when chemically disposed of.

(8) This device should not be used in any type of fluid such as water, oil, organic solvent and etc.

When washing is required, IPA (Isopropyl Alcohol) should be used.

(9) When the LEDs are in operation the maximum current should be decided after measuring the package temperature.



## Precaution for Use

- (10) The appearance and specifications of the product may be modified for improvement without notice.
- (11) Long time exposure of sunlight or occasional UV exposure will cause lens discoloration.
- (12) VOCs (Volatile organic compounds) emitted from materials used in the construction of fixtures can penetrate silicone encapsulants of LEDs and discolor when exposed to heat and photonic energy. The result can be a significant loss of light output from the fixture. Knowledge of the properties of the materials selected to be used in the construction of fixtures can help prevent these issues.
- (13) Attaching LEDs, do not use adhesives that outgas organic vapor.
- (14) The driving circuit must be designed to allow forward voltage only when it is ON or OFF.  
If the reverse voltage is applied to LED, migration can be generated resulting in LED damage.
- (15) Similar to most Solid state devices;  
LEDs are sensitive to Electro-Static Discharge (ESD) and Electrical Over Stress (EOS).  
Below is a list of suggestions that Seoul Semiconductor purposes to minimize these effects.

### a. ESD (Electro Static Discharge)

Electrostatic discharge (ESD) is defined as the release of static electricity when two objects come into contact. While most ESD events are considered harmless, it can be an expensive problem in many industrial environments during production and storage. The damage from ESD to LEDs may cause the product to demonstrate unusual characteristics such as:

- Increase in reverse leakage current lowered turn-on voltage
- Abnormal emissions from the LED at low current

The following recommendations are suggested to help minimize the potential for an ESD event.  
One or more recommended work area suggestions:

- Ionizing fan setup
- ESD table/shelf mat made of conductive materials
- ESD safe storage containers

One or more personnel suggestion options:

- Antistatic wrist-strap
- Antistatic material shoes
- Antistatic clothes

Environmental controls:

- Humidity control (ESD gets worse in a dry environment)

## Precaution for Use

### b. EOS (Electrical Over Stress)

Electrical Over-Stress (EOS) is defined as damage that may occur when an electronic device is subjected to a current or voltage that is beyond the maximum specification limits of the device. The effects from an EOS event can be noticed through product performance like:

- Changes to the performance of the LED package  
(If the damage is around the bond pad area and since the package is completely encapsulated the package may turn on but flicker show severe performance degradation.)
- Changes to the light output of the luminaire from component failure
- Components on the board not operating at determined drive power

Failure of performance from entire fixture due to changes in circuit voltage and current across total circuit causing trickle down failures. It is impossible to predict the failure mode of every LED exposed to electrical overstress as the failure modes have been investigated to vary, but there are some common signs that will indicate an EOS event has occurred:

- Damaged may be noticed to the bond wires (appearing similar to a blown fuse)
- Damage to the bond pads located on the emission surface of the LED package  
(shadowing can be noticed around the bond pads while viewing through a microscope)
- Anomalies noticed in the encapsulation and phosphor around the bond wires.
- This damage usually appears due to the thermal stress produced during the EOS event.

### c. To help minimize the damage from an EOS event Seoul Semiconductor recommends utilizing:

- A surge protection circuit
- An appropriately rated over voltage protection device
- A current limiting device



## Company Information

### Published by

Seoul Semiconductor © 2013 All Rights Reserved.

### Company Information

Seoul Semiconductor ([www.SeoulSemicon.com](http://www.SeoulSemicon.com)) manufactures and packages a wide selection of light emitting diodes (LEDs) for the automotive, general illumination/lighting, Home appliance, signage and back lighting markets. The company is the world's fifth largest LED supplier, holding more than 10,000 patents globally, while offering a wide range of LED technology and production capacity in areas such as "nPola", "Acrich", the world's first commercially produced AC LED, and "Acrich MJT - Multi-Junction Technology" a proprietary family of high-voltage LEDs.

The company's broad product portfolio includes a wide array of package and device choices such as Acrich and Acirch2, high-brightness LEDs, mid-power LEDs, side-view LEDs, and through-hole type LEDs as well as custom modules, displays, and sensors.

### Legal Disclaimer

Information in this document is provided in connection with Seoul Semiconductor products. With respect to any examples or hints given herein, any typical values stated herein and/or any information regarding the application of the device, Seoul Semiconductor hereby disclaims any and all warranties and liabilities of any kind, including without limitation, warranties of non-infringement of intellectual property rights of any third party. The appearance and specifications of the product can be changed to improve the quality and/or performance without notice.