

A

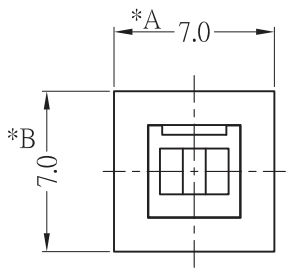

REVISION		
POSITION	DESCRIPTION	DATE
△		

A

B

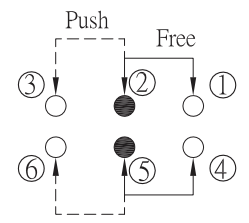
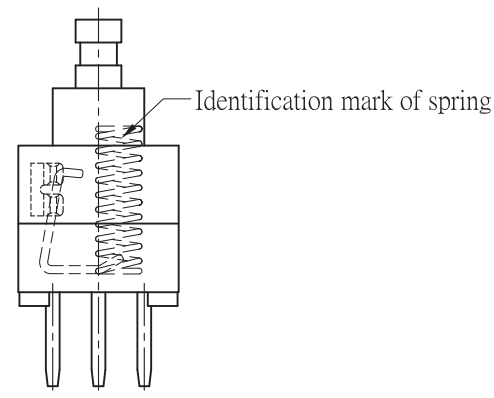
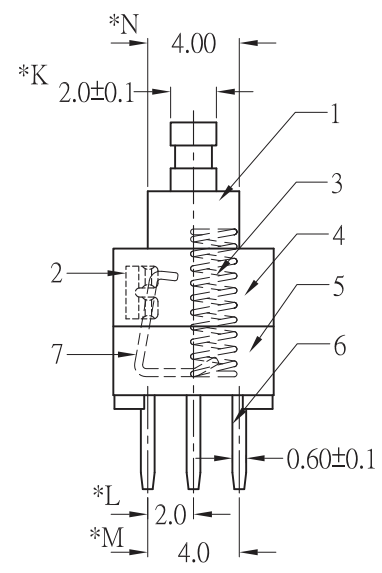
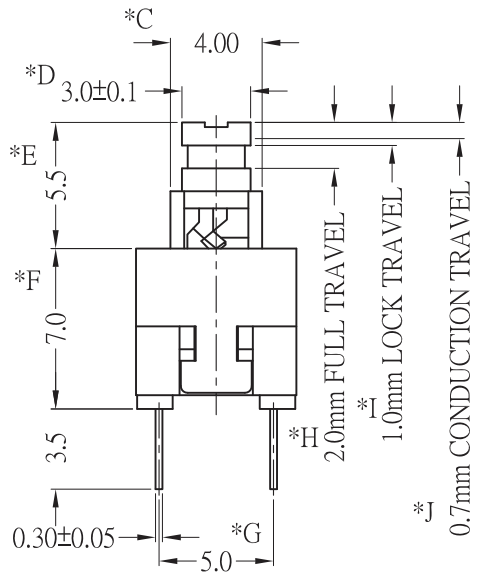

SCHEMATIC

B

C

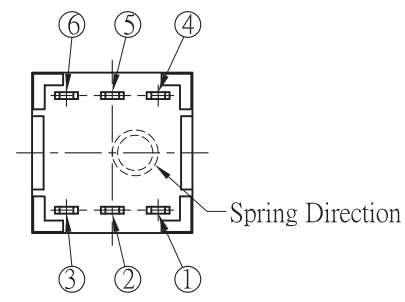

A'-A' VIEW

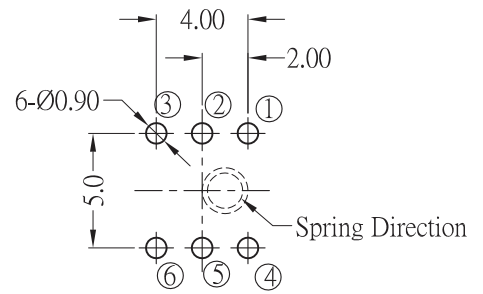

P.C.B.LAYOUT

C

D

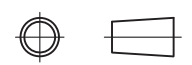

7	CAM STICK	SUS WIRE	1	NATURAL
6	TERMINAL	BRASS STRIP	6	Ag COATING
5	CASE	PA66	1	BLACK
4	COVER	POM	1	WHITE
3	SPRING	SUS	1	NATURAL
2	CONTACT	PBS	2	Ag CLAD
1	KNOB	POM	1	BLUE
NO.	PART NAME	MATERIAL	QTY	FINISHING

SERIES : PUSH SWITCH		DRAWING NO.	CF-ENL-PS4005-2
PART NAME :PS-22E70L		GENERAL TOLERANCE	
UNIT : MM	DWN.	X.XXmm±0.15mm	
SCALE : 5:1	CHK'D	X.Xmm±0.25mm	
REV : A/0	APPD.		

D

* CRITICAL DIMENSION

1

2

3

4